



Sprinter

Operator's Manual



9065849202

Order no. 6462 7502 13 Part no. 906 584 92 02 Edition MY 2014

Sprinter



Mercedes-Benz

Symbols

WARNING

Warning notes make you aware of dangers which could pose a threat to your health or life, or to the health and life of others.

Environmental note

Environmental notes provide you with information on environmentally aware actions or disposal.

 Notes on material damage alert you to dangers that could lead to damage to your vehicle.

 These symbols indicate useful instructions or further information that could be helpful to you.

▶ This symbol designates an instruction you must follow.

▶ Several consecutive symbols indicate an instruction with several steps.

(▷ page) This symbol tells you where you can find further information on a topic.

▷ ▷ This symbol indicates a warning or an instruction that is continued on the next page.

Display This text indicates a message on the display and the rear view camera monitor.

Registered trademarks

ESP® is a registered trademark of Daimler AG.

Vehicle distributor

In the USA:

Mercedes-Benz USA, LLC
One Mercedes Drive
Montvale, NJ 07645-0350
www.mbusa.com
www.mbsprinterusa.com
Customer Assistance Center:
1-877-762-8267

In Canada:

Mercedes-Benz Canada, Inc.
98 Vanderhoof Avenue
Toronto, ON M4G 4C9
www.mercedes-benz.ca
Customer Relations Department:
1-800-387-0100

Mercedes-Benz USA, LLC and Mercedes-Benz Canada Inc. are Daimler companies.
Canada only:

"Authorized Sprinter Dealer" is defined as an authorized Mercedes-Benz Sprinter Dealer.

Publication details

Internet

Further information on Mercedes-Benz vehicles can be obtained on the Internet at
<http://www.mercedes-benz.com>
<http://www.mbusa.com> (USA only)
<http://www.mercedes-benz.ca> (Canada only)

Editorial office

You are welcome to forward any queries or suggestions you may have regarding this Operator's Manual to the technical documentation team at the address on the inside of the front cover.

© Mercedes-Benz USA, LLC

© Mercedes-Benz Canada, Inc.

Mercedes-Benz USA, LLC and Mercedes-Benz Canada Inc. are Daimler companies.

Not to be reprinted, translated, or otherwise reproduced, in whole or in part, without written permission.

Vehicle manufacturer

Daimler AG
Mercedesstraße 137
70327 Stuttgart, Germany
Germany

Welcome to the world of Mercedes-Benz

Before you first drive off, read this Operator's Manual carefully and familiarize yourself with your vehicle. Please adhere to the information and warning notes in this Operator's Manual for your own safety and to ensure a longer operating duration of the vehicle. Failure to observe the instructions may lead to damage to the vehicle or personal injury.

Vehicle damage caused by a failure to observe the instructions is not covered by the New Vehicle Limited Warranty.

These Operating Instructions provides information on the most important functions of your vehicle.

Your vehicle's equipment or product designation may vary, depending on the following:

- model
- order
- country specification
- availability

Individual warning and indicator lamps may not be functional.

We reserve the right to make modifications in the following areas:

- design
- equipment
- technology

Therefore, the descriptions provided may occasionally differ from your own vehicle.

The following are integral components of the vehicle:

- Operator's Manual
- Maintenance Booklet
- service and warranty information
- equipment-dependent operating instructions

Keep these documents in the vehicle at all times. Should you sell the vehicle, always pass the documents on to the new owner.

We wish you safe and pleasant motoring.

Index 4

Introduction 22

At a glance 31

Safety 41

Opening and closing 65

Seats, steering wheel and mirrors 81

Lights and windshield wipers 91

Climate control 111

Driving and parking 135

On-board computer and displays 181

Stowing and features 231

Transporting loads 241

Maintenance and care 249

Breakdown assistance 275

Wheels and tires 285

Technical data 317

- 1, 2, 3 ...**
- 12 V socket** 238
- A**
- ABS (Anti-lock Braking System)**
 Display message 206
 Function/notes 56
 Important safety notes 56
 Indicator lamp 221
- Accessories and conversions**
 see Add-on equipment
- Activating/deactivating cooling with air dehumidification** 117
- Activating/deactivating the roof ventilator** 133
- Active light function** 97
- Adaptive Brake Assist**
 Function/notes 59
- Additional indicators**
 Replacing bulbs (roof) 105
- Additives**
 Diesel 323
 Engine oil 326
- Add-on equipment** 27
- Adjusting the headlamp range** 95
- ADR (working speed governor)** 172
- Air bags**
 Front air bag (driver, front passenger) 45
 Important safety notes 44
 Safety guidelines 43
 Thoraxbag 45
 Window curtain air bag 46
- Air-conditioning system**
 Refrigerant 330
 see Climate control
- Air filter**
 Indicator lamp 228
- Air pressure**
 see Tire pressure
- Air-recirculation mode**
 Important safety notes 120
 Switching on/off 120
- Air vents** 121
 Adjusting for the passenger compartment 121
 Adjusting on the roof 122
 Important safety notes 121
 Setting the center air vents 121
 Setting the side air vents 121
 see Climate control
- Anti-lock Braking System**
 see ABS (Anti-lock Braking System)
- Anti-theft system**
 Interior motion sensor 63
- Armrests** 87
- Ashtray** 237
- ASR (acceleration skid control)**
 Activating/deactivating 60
 Display message 207
 Function/notes 60
 Important safety notes 60
 Indicator lamp 221
- ATA (Anti-Theft Alarm system)**
 Activating/deactivating 62
 Switching off the alarm 62
- Attachments**
 see Add-on equipment
- Authorized workshop**
 see Qualified specialist workshop
- Automatic climate control**
 see Climate control
- Automatic engine start/stop**
 ECO Start (Euro 6 engines) 140
- Automatic headlamp mode** 94
- Automatic locking** 71
- Automatic transmission**
 Accelerator pedal position 146
 Changing gear 145
 Changing gear yourself 145
 Driving tips 146
 Emergency running mode 147
 Important safety notes 144
 Kickdown 146
 Maneuvering 146
 Overview 144
 Problem (malfunction) 147
 Releasing the parking lock manually 147
 Selector lever 144
 Selector lever positions 145
 Shift ranges 146
 Starting the engine 138
 Touchshift 145

- Trailer towing 146
 - Transmission oil change 328
 - Automatic transmission emergency mode** 147
 - Auxiliary heating**
 - Activating/deactivating heater booster mode 130
 - Conditions for switching on 123
 - Heating time 123
 - Important safety notes 122
 - Operating with the button (control panel) 124
 - Operation with the remote control 125
 - Operation with the timer 127
 - Problem (malfunction) 132
 - Selecting a switch-on time 124
 - Setting the switch-on time 125
 - see Auxiliary heating
 - AUX port** 240
 - Axle load, permissible (trailer towing)** 333
- B
- Backup lamps**
 - Replacing bulbs 103
 - Backup lamps (Chassis Cab)**
 - Replacing bulbs 104
 - BAS (Brake Assist System)**
 - Display message 207
 - Function/notes 57
 - Indicator lamp 221
 - Basic settings**
 - see Settings
 - Battery**
 - Isolating switch 136
 - Replacing (SmartKey) 69
 - Battery (SmartKey)**
 - Checking 68
 - Important safety notes 68
 - Replacing 69
 - Battery (vehicle)**
 - Care 266
 - Charge indicator lamp 225
 - Charging 266
 - Disconnecting and connecting (driver's footwell) 262
 - Disconnecting and connecting (engine compartment) 264
 - Disconnecting and reconnecting (base of driver's seat) 265
 - Display message 219
 - Important safety notes 260
 - Installing/removing (base of driver's seat) 266
 - Installing/removing (driver's footwell) 263
 - Installing/removing (engine compartment) 265
 - Jump starting 278
 - Location 261
 - Removing/installing the floor covering (driver's footwell) 261
 - Before driving off**
 - Important safety notes 138
 - Belt**
 - see Seat belts
 - Bleeding the fuel system** 143
 - Blind Spot Assist**
 - Activating/deactivating 166
 - Notes/function 164
 - Trailer towing 166
 - Bodies**
 - Body/equipment mounting directives for trucks 28
 - Bottle holder** 237
 - see Cup holder
 - Brake Assist System**
 - see BAS (Brake Assist System)
 - Brake fluid**
 - Checking the level 256
 - Display message 208
 - Notes 328
 - Warning lamp 222
 - Brake force distribution, electronic**
 - see EBD (electronic brake force distribution)
 - Brake lamps**
 - Replacing bulbs 103
 - Brake lamps (Chassis Cab)**
 - Replacing bulbs 104
 - Brake linings**
 - Display message 207
 - Indicator lamp 225

Brakes

ABS	56
Adaptive Brake Assist	59
Applying the parking brake	152
BAS	57
Brake fluid (notes)	328
Checking brake fluid level	256
Display messages	207
EBD	57
Important safety notes	156
Maintenance	221
Parking brake (notes)	157
Riding tips	156

Brake system

Malfunction	207
Warning lamp	221

Breakdown

Fire extinguisher	278
First-aid kit	277
Jump-starting	278
Reflective safety jacket	277
Vehicle tool kit	276
Warning lamp	277
Warning triangle	277
see Flat tire	
see Towing away	
see Tow-starting	

Bulb

see Changing a bulb

Bulb failure indicator 92**C****Care**

Car wash	267
Display	272
Exterior lights	270
Notes	267
Paint	269
Plastic trim	272
Power washer	268
Rear view camera	271
Roof lining	273
Seat belt	273
Seat cover	272
Selector lever	272
Sensors	270
Sliding door	271

Steering wheel	272
Step (electrical)	271
Trim pieces	272
Washing by hand	268
Washing the engine	269
Wheels	269
Windows	269
Wiper blades	270

Cargo compartment

Activating/deactivating ventila- tion	133
--	-----

Cargo compartment floor 28**Cargo tie-down points and tie
downs**

Important safety notes	244
------------------------------	-----

Cargo tie-down rings

Installing	246
Permissible tensile load	331

Car wash (care) 267**CD player/CD changer** 190**Cell phone**

see Mobile phone

Center console overview 37**Central locking**

Automatic locking	71
Important safety notes	71
Locking/unlocking (buttons)	71
Locking/unlocking (SmartKey)	66
Locking/unlocking manually	71

Central locking system

see Central locking

Changing bulbs

Additional indicators (roof)	105
Backup lamp (Chassis Cab)	104
Backup lamps	103
Bi-Xenon bulbs	100
Brake lamps	103
Brake lamps (Chassis Cab)	104
Cornering lamps	102
Courtesy lights	105
Daytime running lamps (halogen headlamps)	102
Display message	210
Front interior light	106
High-beam headlamps	101
Interior light	106
Interior lighting	106
License plate lamp	104

- License plate lamp (Chassis Cab) .. 104
- Low-beam headlamps 101
- Overview of lamp types (front bulbs) 101
- Overview of lamp types (rear bulbs, Cargo Van/Passenger Van) .. 103
- Overview of lamp types (rear bulbs, Chassis Cab) 104
- Perimeter lamp 104, 105
- Rear fog lamp 103
- Rear fog lamp (Chassis Cab) 104
- Rear interior light 106
- Standing lamps (rear, Chassis Cab) 104
- Standing lamps (rear) 103
- Tail lamps 103
- Tail lamps (Chassis Cab) 104
- Turn signals (front) 102
- Turn signals (rear, Chassis Cab) 104
- Turn signals (rear) 103
- Warning and indicator lamps 230
- see Replacing bulbs
- Checklist**
- Before driving off-road 160
- Child-proof locks**
- Important safety notes 54
- Rear door 55
- Sliding door 55
- Children**
- In the vehicle 50
- Restraint systems 50
- Special seat belt retractor 54
- Child seat**
- LATCH-type (ISOFIX) child seat anchors 52
- Top Tether 53
- Chock** 153
- Cigarette lighter** 238
- Cleaning**
- Mirror turn signal 270
- Trailer tow hitch 271
- Climate control**
- Air-conditioning system 114
- Auxiliary heating 122
- Checking/cleaning the air filter (rear-compartment air conditioning) 258
- Cooling with air dehumidification .. 117
- Defrosting the windows 118
- Heating 113
- Important safety notes 112
- Operating the cargo compartment air vents 133
- Overview of systems 112
- Problems with the windshield heating 119
- Problem with the rear window defroster 120
- Rear-compartment air conditioning 116
- Rear-compartment heating 115
- Reheat function (air dehumidification) 118
- Setting the air distribution 117
- Setting the airflow 118
- Setting the air vents 121
- Setting the temperature 117
- Switching air-recirculation mode on/off 120
- Switching on/off 116
- Switching the rear window defroster on/off 120
- Switching windshield heating on/off 119
- Cockpit**
- Overview 32
- see Instrument cluster
- COLLISION PREVENTION ASSIST**
- Activating/deactivating the distance warning function 59
- Operation/notes 58
- COMAND display**
- Cleaning 272
- Combination switch** 95
- Communications equipment**
- Operation 239
- PND fittings 240
- Ports 240
- Type approval/frequency 318
- Consumption statistics (on-board computer)** 197
- Control panel**
- Above the windshield 38
- Center console 37
- Climate control 37

- Driver's door 39
 - Left and right side of the steering wheel 39
 - Conversions/equipment** 27
 - Conversions and accessories**
see Add-on equipment
 - Coolant (engine)**
 - Adding 256
 - Checking the level 255
 - Displaying the temperature (on-board computer) 189
 - Display message 214
 - Filling capacity 330
 - Important safety notes 255
 - Cooling**
see Climate control
 - Cornering lamps**
Replacing bulbs 102
 - Cornering light function**
Function/notes 96
 - Courtesy lights**
Replacing bulbs 105
 - Cruise control**
 - Activating 162
 - Activation conditions 162
 - Cruise control lever 162
 - Deactivating 163
 - Display message 216
 - Driving system 161
 - Function/notes 161
 - Important safety notes 161
 - Problem (malfunction) 164
 - Resuming the stored speed 162
 - Setting a speed 163
 - Storing and maintaining current speed 162
 - Cup holders** 236
 - Curtains (cleaning instructions)** 273
 - Customer Assistance Center (CAC)** ... 28
 - Customer Relations Department** 28
- D**
- Dashboard**
see Cockpit
 - Data**
see Technical data
 - Daytime running lamp mode**
see Daytime running lamps
 - Daytime running lamps**
 - Activating/deactivating (vehicles with steering wheel buttons) 194
 - Changing bulbs (halogen headlamps) 102
 - Switching on/off (switch) 93
 - Switching on/off (vehicles without steering wheel buttons) 185
 - Declarations of conformity** 25
 - DEF (Diesel Exhaust Fluid)**
 - Refilling 149
 - Delayed switch-off** 195
 - Diagnostics connection** 25
 - Diesel** 322
 - Diesel engine**
 - Preglow indicator lamp 228
 - Diesel Exhaust Fluid (DEF)**
 - Display messages (vehicles without steering wheel buttons) 202
 - Display messages (vehicles with steering wheel buttons) 213
 - Exhaust gas aftertreatment 27
 - Indicator lamp 224
 - Information on consumption 325
 - Level indicator 184
 - Notes 324
 - Ranges 27
 - Storage 325
 - Tank content 325
 - Diesel particle filter**
 - Display message 213
 - Short-distance driving 155
 - Digital speedometer**
 - Setting the unit (vehicles with steering wheel buttons) 192
 - Digital speedometer and odometer**
 - Operating safety 25
 - Display**
 - Display messages 199
 - Outside temperature (vehicles with steering wheel buttons) 189
 - Outside temperature display (vehicles without steering wheel buttons) 184

- Standard display (vehicles without steering wheel buttons) 184
- Standard display (vehicles with steering wheel buttons) 189
- see Warning and indicator lamps
- Display messages**
 - Calling up the message memory 200
 - Driving systems 216
 - Engine 213
 - Important safety notes 199
 - Lights 210
 - Safety systems 206
 - SmartKey 220
 - Tires 218
 - Vehicle 219
- Distance recorder** 189
- see Odometer
- see Trip odometer
- Distance warning function**
 - Activating/deactivating 59
 - Function/notes 58
 - Warning lamp 59
- Door lock**
 - see Central locking
- Doors**
 - Central locking/unlocking (SmartKey) 66
 - Control panel 39
 - Display message 220
 - Indicator lamp 230
- Drinking and driving** 154
- Drinks holder**
 - see Bottle holder
 - see Cup holder
- Driver's/co-driver's door**
 - Unlocking 72
- Driver's seat**
 - see Seats
- Driving abroad** 155
- Driving off-road**
 - see Off-road driving
- Driving on flooded roads** 157
- Driving on rough terrain**
 - Checklist before driving off-road 160
- Driving safety systems**
 - ABS (Anti-lock Braking System) 56
 - Adaptive Brake Assist 59
 - ASR (Acceleration Skid Control) 60
 - BAS (Brake Assist System) 57
 - Distance warning function 58
 - EBD (electronic brake force distribution) 57
 - Important safety information 56
 - Overview 56
- Driving systems**
 - Blind Spot Assist 164
 - Cruise control 161
 - Display message 216
 - Lane Keeping Assist 166
 - PARKTRONIC 168
- Driving tips**
 - Automatic transmission 146
 - Brakes 156
 - Break-in period 136
 - Downhill gradient 156
 - Drinking and driving 154
 - Driving abroad 155
 - Driving in winter 158
 - Driving on flooded roads 157
 - Driving on wet roads 157
 - Exhaust check 154
 - Fuel 154
 - General 153
 - Hydroplaning 157
 - Icy road surfaces 158
 - Important safety notes 136
 - Limited braking efficiency on salted roads 157
 - Off-road driving 159
 - Overrun cut-off 154
 - Snow chains 289
 - Speed limitation 155
 - Towing a trailer 173
 - Transport by rail 156
 - Wet road surface 156

E

- EBD (electronic brake force distribution)**
 - Display message 208
 - Function/notes 57
 - Indicator lamps 221
- ECO Start (Euro 6 engines)**
 - General notes 140
- Electrical closing assist** 73

- Electrical fuses**
see Fuses
- Electrical step**
Cleaning 271
Display message 219
Emergency release 74
Function 74
Important safety notes 73
Indicator lamp 230
Manual retraction 74
Obstacle detection 74
- Electrical system**
Battery main switch 136
- Electronic Stability Program**
see ESP® (Electronic Stability Program)
- Emergency exit** 61
- Emergency exit window** 61
- Emergency Tensioning Devices**
Function 50
Safety guidelines 43
- Emissions control**
Service and warranty information 23
- Engine**
ADR (working speed governor) 172
Changing the power output 25
Check Engine warning lamp 227
Cleaning instructions 269
ECO Start (Euro 6 engines) 140
Engine number 320
Engine speed setting (working mode) 173
Irregular running 143
Jump-starting 278
Operating safety 25
Starting 138
Starting problems 143
Switching off 152
Tow-starting (vehicle) 282
- Engine, jump-starting** 278
- Engine electronics**
Notes 318
Problem (malfunction) 143
- Engine oil**
Adding 254
Additives 326
Checking the oil level (on-board computer) 252
Checking the oil level using the dipstick 253
Display message 216
Filling capacity 327
Information about oil consumption 327
Mixing 327
Notes about oil grades 326
Oil change 327
Oil level (note) 252
Viscosity 326
Warning lamp 225
- Engine speed setting (working mode)** 172
- Equipment/conversions** 27
- ESP® (Electronic Stability Program)**
Display message 209
Important safety information 57
Indicator lamp 224
Warning lamp 221
- Exhaust check** 154
- Exhaust gas aftertreatment** 27
DEF level indicator 184
DEF reducing agent 324
Diesel Exhaust Fluid (DEF) 324
Display messages (vehicles without steering wheel buttons) 202
Display messages (vehicles with steering wheel buttons) 213
Indicator lamp 224, 228
Malfunction 213
Refilling DEF 149
- Exterior lighting** 92
see Lights
- Exterior mirrors**
Adjusting 89
Important safety notes 89
- Eyeglasses compartment** 233

F

- Fire extinguisher** 278
- First-aid kit** 277
- Flat tire**
Changing a wheel/mounting the spare wheel 308
General notes 307

Fog lamps	
Switching on/off	94
Folding seat	85
Folding table	236
In the twin co-driver's seat	236
Frequencies	
Mobile phone	318
Two-way radio	318
Front fog lamps	
Switching on/off	94
Front interior light	
Replacing bulbs	106
Front windshield	
see Windshield	
Fuel	
Additives (diesel)	323
Consumption information	323
Consumption statistics	197
Diesel at very low outside temperatures	323
Display message	215
Driving tips	154
Fuel gauge	183
Important safety notes	321
Problem (malfunction)	149
Quality (diesel)	322
Refueling	148
Showing the range (on-board computer with steering wheel buttons)	197
Showing the range (vehicles with steering wheel buttons)	197
Tank content/reserve fuel	322
Fuel filter with water separator	
draining	257
Indicator lamp	229
Fuel gauge	183
Fuel tank	
Problem (malfunction)	149
Fuel tank content	
Reserve, display message	215
Fuses	283

G

Gasoline	
Reserve fuel warning lamp	227
General driving tips	
Driving short distances	155
Genuine parts	318
Glove box	232
GTW (Gross Trailer Weight) (definition)	305
Guarantee	23

H

Hazard warning lamps	96
Headlamps	
Adding fluid to cleaning system	257
Cleaning system (function)	96
Fogging up	98
see Automatic headlamp mode	
Headliner (cleaning instructions)	273
Head restraints	
Adjusting	86
Adjusting (rear)	86
Heating	
see Climate control	
Highbeam Assist	
Function/notes	97
Switching Highbeam Assist on/off	194
High-beam headlamps	
Highbeam Assist	97
Replacing bulbs	101
Switching on/off	95
Hood	
Closing	251
Display message	220
Indicator lamp	230
Opening	250
Hydroplaning	157

I

Immobilizer	62
Indicator lamp	
see Warning and indicator lamps	
Indicators	
see Turn signals	
Insect protection on the radiator	28

Installing/removing the ball coupling	175
Instrument cluster	
Fuel gage	183
Important safety notes	182
Instrument cluster lighting	183
Outside temperature display	183
Overview	34
Speedometer	183
Tachometer	183
Warning and indicator lamps	35
Instrument cluster lighting	183
Instrument lighting	
see Instrument cluster lighting	
Interior lighting	98
Front	98
Motion detectors	100
Notes on replacing bulbs	106
Replacing bulbs	106
Switching the rear compartment lighting on centrally	99
Interior motion sensor	
Arming	63
Deactivating	64
Function	63
Switching off	64

J

Jack	
Jacking points	309
Preparation	309
Storage location	276
Using	309
Jump-starting	278

K

Key	
Position in the ignition lock	137
see SmartKey	
Kickdown	146

L

Lamps	
see Warning and indicator lamps	
Lane Keeping Assist	
Activating/deactivating	167
Function/notes	166
Language	
Display (vehicles with steering wheel buttons)	192
Lashing points and tie downs	
Permissible tensile load	331
LATCH-type (ISOFIX) child seat anchors	52
License plate lamp	
Replacing bulbs	104
License plate lamp (Chassis Cab)	
Replacing bulbs	104
Lighting	
Light switch	93
see Lights	
Lights	
Activating/deactivating daytime running lamps (on-board computer with steering wheel buttons)	194
Activating/deactivating daytime running lamps (vehicles with steering wheel buttons)	93
Activating/deactivating surround lighting (vehicles with steering wheel buttons)	195
Active light function	97
Automatic headlamp mode	94
Bulb failure indicator	92
Cornering light function	96
Driving abroad	155
Fog lamps	94
Hazard warning lamps	96
Headlamp range	95
Highbeam Assist	97
High beam flasher	95
High-beam headlamps	95
Low-beam headlamps	93
Parking lamps	93
Rear fog lamp	94

- Setting the exterior lighting delayed switch-off (vehicles with steering wheel buttons) 195
 - Steering the daytime running lamps on/off (switch) 93
 - Turn signals 95
 - see Changing a bulb
 - see Interior lighting
 - Light sensor** 94
 - Limited Warranty** 29
 - Load distribution** 244
 - Loading guidelines**
 - Important safety notes 242
 - Loading rails**
 - Installing cargo tie-down rings 246
 - Maximum tensile strength 331
 - Loads**
 - Securing 244
 - Transporting 242
 - Load securing aids**
 - Carrier systems 247
 - Locator lighting**
 - Setting (vehicles with steering wheel buttons) 195
 - Locking**
 - see Central locking
 - Locking and unlocking manually** 71
 - Locking centrally**
 - see Central locking
 - Low-beam headlamps**
 - Display message 210
 - Driving abroad 155
 - Replacing bulbs 101
 - Switching on/off 93
 - Lumbar support** 83
- M**
- M+S tires** 288
 - Maintenance** 258
 - Malfunctions**
 - Message memory (on-board computer) 200
 - Maximum speed**
 - Speed limitation 155
 - Menu (vehicles with steering wheel buttons)**
 - Audio 189
 - Operation 188
 - Settings 190
 - Telephone 198
 - Message**
 - see Display message
 - Message memory (on-board computer)** 200
 - Mirrors**
 - Exterior mirrors 89
 - Rear-view mirror 89
 - Mobile navigation devices** 240
 - Mobile phone** 239
 - Important safety notes 239
 - Pre-installation 239
 - Type approval/frequency 318
 - Mounting wheels**
 - Lowering the vehicle 312
 - Mounting a new wheel 311
 - Preparing the vehicle 308
 - Raising the vehicle 309
 - Removing and mounting the spare wheel 314
 - Removing a wheel 311
 - Securing the vehicle against rolling away 308
- N**
- Navigation**
 - Fittings for PND mobile navigation devices 240
 - Navigation lights**
 - Replacing bulbs 101
 - Notes on breaking-in a new vehicle** 136
- O**
- Occupant safety**
 - Air bags 44
 - Children in the vehicle 50
 - Important safety notes 42

- Pets in the vehicle 56
 - Seat belts 47
 - Odometer**
 - Display (vehicles without steering wheel buttons) 184
 - Display (vehicles with steering wheel buttons) 189
 - Off-road driving**
 - Checklist after driving off-road 160
 - Important safety notes 159
 - Rules for driving off-road 160
 - Oil**
 - see Engine oil
 - On-board computer**
 - Display message 199
 - Lighting submenu 194
 - On-board computer (vehicles without steering wheel buttons)**
 - Display message 199
 - General notes 184
 - Setting the clock 185
 - Standard display 184
 - On-board computer (vehicles with steering wheel buttons)**
 - Audio menu 189
 - Display message 186
 - Menu overview 188
 - Operating 186
 - Operation menu 188
 - Settings menu 190
 - Standard display 189
 - Telephone menu 198
 - Trip computer menu 197
 - Operating safety**
 - Attachments, bodies, equipment and conversions 27
 - Correct use 26
 - Declaration of conformity 25
 - Diagnostics connection 25
 - Digital speedometer and odometer 25
 - Important safety note 24
 - Limited Warranty 29
 - Modifying engine output 25
 - Qualified specialist workshop 26
 - Radiator cover 28
 - Vehicle registration 23
 - Warning note sticker 26
 - Operating system**
 - see On-board computer
 - Operator's Manual**
 - General notes 23
 - Vehicle equipment 23
 - Outline lamp**
 - Replacing bulbs 105
 - Outside temperature display** 183
 - Overhead control panel** 38
 - Overrevving range** 183
 - Overrun cutoff** 154
- P**
- Paint code number** 319
 - Paintwork (cleaning instructions)** ... 269
 - Paper holder** 236
 - Parking** 151
 - Important safety notes 151
 - Parking brake 152
 - Wheel chock 153
 - see PARKTRONIC
 - Parking aid**
 - see PARKTRONIC
 - Parking brake**
 - Display message 209
 - Notes/function 152
 - PARKTRONIC**
 - Deactivating/activating 170
 - Driving system 168
 - Function/notes 168
 - Important safety notes 168
 - Problem (malfunction) 171
 - Range of the sensors 168
 - Roll-back warning 170
 - Trailer towing 170
 - Warning display 169
 - Partition sliding door**
 - Important safety notes 77
 - Opening/closing 77
 - Passenger compartment air-conditioning system**
 - see Climate control
 - Passenger compartment heating**
 - see Climate control
 - Perimeter lamp**
 - Replacing bulbs 104
 - Pets in the vehicle** 56

- Plastic trim (cleaning instructions) ..** 272
- Power supply**
- Battery isolating switch 136
 - Switching off 137
 - Switching on 137
- Power take-off**
- Engine speed setting 172
- Power washers** 268
- Power windows**
- see Side windows
- Preparing for a journey**
- Checks in the vehicle 138
 - Visual check of the vehicle exterior 138
- Product information** 22
- Protection of the environment**
- General notes 22
- Pulling away** 139
- Q**
- Qualified specialist workshop** 26
- R**
- Radiator cover** 28
- Radio**
- Changing stations (vehicles with steering wheel buttons) 189
 - Setting station selection (vehicles with steering wheel buttons) 196
 - see separate operating instructions
- Rain and light sensor**
- Setting the sensitivity (vehicles with steering wheel buttons) 196
 - Windshield wiper 107
- Range (vehicles with steering wheel buttons)** 197
- Rear bench seat**
- Installing/removing (Passenger Van) 85
 - Stowage compartment (crewcab) .. 235
- Rear compartment**
- Activating/deactivating climate control 116
 - Setting the air vents 122
- Rear-compartment air-conditioning system**
- see Climate control
- Rear-compartment heating**
- see Climate control
- Rear door**
- Child-proof locks 55
 - Important safety notes 75
 - Opening/closing 75
- Rear fog lamp**
- Replacing bulbs 103
 - Switching on/off 94
- Rear fog lamp (Chassis Cab)**
- Replacing bulbs 104
- Rear interior light**
- Replacing bulbs 106
- Rear lamps**
- see Lights
- Rear rack**
- Notes 247
- Rear view camera**
- Cleaning instructions 271
 - Important safety notes 171
 - Switching on 171
- Rear-view mirror**
- Anti-glare mode 89
- Rear window defroster**
- Problem (malfunction) 120
 - Switching on/off 120
- Rear window wiper** 108
- Switching on/off 108
- Refilling**
- DEF filler neck 150
 - Important safety notes (Diesel Exhaust Fluid – DEF) 149
 - Refilling procedure (Diesel Exhaust Fluid – DEF) 150
- Refrigerant** 330
- Refueling**
- Fuel filler flap 148
 - Fuel gauge 183
 - Important safety notes (fuel) 148
 - Refueling procedure (fuel) 148
 - see Fuel
- Releasing the parking lock manually (automatic transmission)** 147

- Remote control**
 - Changing the operating duration (auxiliary heating) 126
 - Replacing the battery (auxiliary heating) 130
 - Switching on/off (auxiliary heating) 126
 - Synchronizing (auxiliary heating) ... 126
 - Replacing bulbs**
 - Important safety notes 100
 - Navigation lights 101
 - Replacing the battery (auxiliary heating remote control)** 130
 - Restraint system**
 - see SRS (Supplemental Restraint System)
 - Reverse warning feature** 140
 - Roof carrier**
 - Maximum payload 331
 - Notes 247
 - Roof load (roof carrier)** 331
- S**
- Safety**
 - Children in the vehicle 50
 - Child restraint systems 50
 - Safety systems**
 - see Driving safety systems
 - Seat belts**
 - Adjusting the height 48
 - Belt force limiters 50
 - Belt warning/warning lamp 49
 - Cleaning 273
 - Correct usage 47
 - Display message 209
 - Emergency Tensioning Devices 50
 - Fastening 48
 - Important safety guidelines 47
 - Safety guidelines 43
 - Warning lamp 230
 - Seat heating** 87
 - Seats**
 - Adjusting lumbar support 83
 - Adjusting the co-driver's seat 83
 - Adjusting the head restraint 86
 - Armrest 87
 - Cleaning the cover 272
 - Correct driver's seat position 82
 - Folding seat 85
 - Important safety notes 82
 - Rear bench seat 85
 - Seat heating 87
 - Setting the driver's seat 83
 - Swivel seat 84
 - Twin co-driver's seat 85
 - Securing loads**
 - Important safety notes 244
 - Selector lever**
 - Cleaning 272
 - Sensors (cleaning instructions)** 270
 - Service Center**
 - see Qualified specialist workshop
 - Service interval display**
 - Calling up the service due date 260
 - Exceeding a service due date 260
 - Notes 259
 - Service due date (automatic display) 259
 - Service products**
 - Brake fluid 328
 - Coolant (engine) 329
 - Diesel 321
 - Diesel Exhaust Fluid (DEF) 324
 - Engine oil 326
 - Fuel 321
 - Important safety notes 320
 - Power steering fluid 328
 - Refrigerant 330
 - Transmission oil 328
 - Washer fluid 330
 - Settings**
 - Resetting all (vehicles with steering wheel buttons) 190
 - Resetting submenus (vehicles with steering wheel buttons) 191
 - Setting the air distribution** 117
 - Setting the airflow** 118
 - Setting the clock**
 - Vehicles without steering wheel buttons 185
 - Vehicles with steering wheel buttons 193
 - Short journeys (diesel particle filter)** 155

- Side windows**
 - Cleaning 269
 - Hinged side windows 78
 - Important safety information 78
 - Opening/closing 78
 - Overview 78
 - Problem (malfunction) 79
 - Resetting 79
- Sliding door**
 - Child-proof locks 55
 - Cleaning 271
 - Closing assist 73
 - Important safety notes 72
 - Opening/closing 72
- SmartKey**
 - Changing the battery 69
 - Changing the locking system settings 196
 - Checking the battery 68
 - Display message 220
 - Door central locking/unlocking 66
 - Important safety notes 66
 - Loss 70
 - Problem (malfunction) 70
- SmartKey positions (ignition lock) ..** 137
- Snow chains** 289
- Sockets** 238
- Spare wheel**
 - General notes 314
 - Important safety notes 313
 - Removing/mounting 314
- Specialist workshop** 26
- Special seat belt retractor** 54
- Speed, controlling**
 - see Cruise control
- Speedometer**
 - Digital (vehicles without steering wheel buttons) 184
 - Digital (vehicles with steering wheel buttons) 193
 - Selecting display unit (vehicles with steering- wheel buttons) 192
 - see Instrument cluster
- Sprinter Dealer**
 - see Qualified specialist workshop
- SRS (Supplemental Restraint System)**
 - Introduction 42
 - Warning lamp (function) 42, 225
- Standing lamps**
 - Replacing bulbs (rear) 103
- Standing lamps (Chassis Cab)**
 - Replacing bulbs (rear) 104
- Starting (engine)** 138
- Start-off assist**
 - Display message 207
- Steering wheel**
 - Adjusting 88
 - Button overview 37
 - Cleaning 272
- Step**
 - see Electrical step
- Sticker**
 - Warning notes 26
- Stowage spaces**
 - see Stowage spaces and stowage compartments
- Stowage spaces and stowage compartments**
 - Eyeglasses compartment 233
 - Glove box 232
 - Important safety notes 232
 - Paper holder 236
 - Stowage compartment above the windshield 234
 - Stowage compartment in the center console 234
 - Stowage compartment in the dashboard 233
 - Stowage space above the headliner 234
 - Stowage space under the rear bench seat 235
 - Stowage space under the twin co-driver's seat 235
- Summer tires** 288
- Supplemental Restraint System**
 - see SRS (Supplemental Restraint System)
- Switching off the alarm (ATA)** 62
- Switching the heater booster function on/off** 130

- Switching the surround lighting on/off (on-board computer)** 195
- Switch unit**
see Control panel
- Swivel seat** 84
- T**
- Tachometer** 183
- Tail lamps**
Changing 104
Replacing bulbs 103
see Lights
- Tail lamps (Chassis Cab)**
Replacing bulbs 104
- Tank**
see Fuel tank
- Tank content**
Fuel gauge 183
Range (vehicles with steering wheel buttons) 197
Reserve fuel warning lamp 227
- Technical data**
Capacities 320
Cargo tie-down points 331
Cargo tie-down rings 331
Loading rails 331
Roof carrier 331
Tires/wheels 297
Trailer tow hitch 332
Vehicle data 331
- Telephone** 239
- Telephone (on-board computer)**
Accepting an incoming call 198
Display messages 220
Numbers from the phone book 198
Operating 198
Redialing 199
Rejecting or ending a call 198
- Temperature**
Outside temperature 183
Setting (climate control) 117
Setting the unit (vehicles with steering wheel buttons) 191
- Theft deterrent systems**
ATA (Anti-Theft Alarm system) 62
Immobilizer 62
Tow-away alarm 63
- Thoraxbag** 45
- Tightening torques for wheel nuts/wheel bolts** 312
- Time**
Setting the time (vehicles without steering wheel buttons) 185
Setting the time (vehicles with steering wheel buttons) 193
- Timer**
Activating 128
Important safety notes 127
Overview 127
Setting the heating level (auxiliary heating) 130
Setting the preselection time (auxiliary heating) 129
Setting weekday, time and operating duration (auxiliary heating) ... 128
Switching immediate heating mode on/off (auxiliary heating) 128
- Tire pressure**
Calling up (on-board computer) 293
Checking manually 292
Display messages (vehicles without steering wheel buttons) 201
Display messages (vehicles with steering wheel buttons) 218
Maximum 292
Notes 291
Recommended 290
Setting the unit (vehicles with steering wheel buttons) 193
Tire label 290, 291
- Tire pressure loss warning system** .. 294
- Tire pressure monitor**
Display message 218
Indicator lamp 229
- Tire pressure monitoring system**
Checking the tire pressure electronically 294
Function/notes 293
Restarting 295
Warning lamp 294
- Tire pressure table** 297
- Tires**
Aspect ratio (definition) 306
Average weight of the vehicle occupants (definition) 305

Bar (definition)	304	Summer tires	288
Changing a wheel	307	TIN (Tire Identification Number)	
Characteristics	304	(definition)	306
Checking	287	Tire bead (definition)	306
Definition of terms	304	Tire pressure (definition)	306
Direction of rotation	308	Tire pressures (recommended)	305
Distribution of the vehicle occu- pants (definition)	307	Tire size (data)	297
DOT, Tire Identification Number (TIN)	304	Tire size designation, load-bearing capacity, speed rating	302
DOT (Department of Transporta- tion) (definition)	305	Tire tread	287
GAWR (Gross Axle Weight Rating) (definition)	305	Tire tread (definition)	306
GTW (Gross Trailer Weight) (defi- nition)	305	Total load limit (definition)	307
GVW (Gross Vehicle Weight) (defi- nition)	305	Traction (definition)	307
GVWR (Gross Vehicle Weight Rat- ing) (definition)	305	TWR (permissible trailer drawbar noseweight) (definition)	307
Important safety notes	286	Uniform Tire Quality Grading	
Increased vehicle weight due to optional equipment (definition)	305	Standards (definition)	305
Kilopascal (kPa) (definition)	305	Unladen weight (definition)	306
Labeling (overview)	301	valve, Snap-In	292
Load bearing index (definition)	306	Wear indicator (definition)	307
Load index	303	Wheel rim (definition)	305
Load index (definition)	306	Top Tether	53
M+S tires	288	Touchshift (automatic transmis- sion)	145
Maximum loaded vehicle weight (definition)	305	Tow-away alarm	
Maximum load on a tire (defini- tion)	306	Arming/deactivating	63
Maximum permissible tire pres- sure (definition)	306	Deactivating	63
Maximum tire load	303	Operation	63
Maximum tire load (definition)	306	Towing	
Optional equipment weight (defi- nition)	306	If the vehicle is stuck	282
PSI (pounds per square inch) (def- inition)	306	Important safety guidelines	279
Replacing	307	Installing/removing the towing eye	280
Service life	288	In the event of malfunctions	281
Sidewall (definition)	306	With a raised front or rear axle	281
Speed rating (definition)	305	Towing a trailer	
Storing	308	Axle load, permissible	333
Structure and characteristics (definition)	304	Cleaning the trailer tow hitch	271
		Coupling up a trailer	176
		Decoupling a trailer	177
		Driving tips	173
		Important safety notes	173
		Installing and removing the ball coupling	175
		Notes on retrofitting	332
		Power supply	179
		Trailer loads	333

- Towing away**
 - With both axles on the ground 282
 - Tow-starting**
 - Emergency engine starting 282
 - Important safety notes 279
 - Trailer**
 - Brake force booster malfunction ... 222
 - Trailer coupling**
 - see Trailer tow hitch
 - Trailer loads and drawbar nose-weights** 178
 - Trailer towing**
 - Blind Spot Assist 166
 - PARKTRONIC 170
 - Permissible trailer loads and drawbar noseweights 178
 - Transmission**
 - see Automatic transmission
 - Transmission oil** 328
 - Transport**
 - Loading guidelines 242
 - Vehicle 282
 - Transportation**
 - Rail 156
 - Transport by rail** 156
 - Transporting**
 - Load distribution 244
 - Securing a load 244
 - Trim pieces (cleaning instructions)** .. 272
 - Trip computer (on-board computer)** 197
 - Trip meter**
 - see Trip odometer
 - Trip odometer**
 - Display (vehicles without steering wheel buttons) 184
 - Display (vehicles with steering wheel buttons) 189
 - Resetting 183
 - see Trip computer (on-board computer)
 - Turn signals**
 - Replacing bulbs (front) 102
 - Replacing bulbs (rear) 103
 - Switching on/off 95
 - Turn signals (Chassis Cab)**
 - Replacing bulbs (rear) 104
 - Twin co-driver's seat**
 - Folding table 236
 - Stowage compartment 235
 - Two-way radios**
 - Type approval/frequency 318
 - TWR (Tongue Weight Rating) (definition)** 307
- ## U
- Unlocking**
 - From inside the vehicle (central unlocking button) 71
 - USB port** 240
- ## V
- Vehicle**
 - Correct use 26
 - Data acquisition 29
 - Display message 219
 - Electronics 318
 - Equipment 23
 - Individual settings (vehicles with steering wheel buttons) 190
 - Limited Warranty 29
 - Loading 298
 - Locking (SmartKey) 66
 - Lowering 312
 - Maintenance 23
 - Operating safety 24
 - Parking for a long period 153
 - Pulling away 139
 - Raising 309
 - Registration 23
 - Reporting problems 28
 - Securing from rolling away 151
 - Towing away 279
 - Transporting 282
 - Unlocking (SmartKey) 66
 - Vehicle battery**
 - see Battery (vehicle)
 - Vehicle bodies**
 - General notes 27
 - Vehicle data** 331
 - Vehicle identification number** 319
 - Vehicle identification plate** 319
 - Vehicle tool kit** 276

- Ventilation**
 - Setting the vents 121
 - Voltage supply**
 - Fuses 283
- W**
- Warning and indicator lamps**
 - Brakes 222
 - Check Engine 227
 - Coolant 226
 - Diesel Exhaust Fluid (DEF) 224
 - Electrical step 230
 - ESP® 221
 - ESP® function 224
 - Overview 35
 - Seat belt 230
 - Warning- and indicator lamps**
 - ABS 221
 - Air filter 228
 - ASR 221
 - BAS 221
 - Battery charge 225
 - Brake wear 225
 - Bulbs 230
 - Doors 230
 - Engine oil level 225
 - Preglow 228
 - Reserve fuel 227
 - Tire pressure monitor 229
 - Water separator 229
 - Windshield washer fluid 229
 - Warning lamp** 277
 - Warning triangle** 277
 - Washer fluid**
 - Adding 257
 - Capacities 331
 - Display message 220
 - Indicator lamp 229
 - Notes 330
 - Wiping with 107
 - Wheels**
 - Changing a wheel 307
 - Checking 287
 - Cleaning 269
 - Important safety notes 286
 - Interchanging/changing 307
 - Mounting a wheel 308
 - Removing and mounting the spare wheel 314
 - Storing 308
 - Tightening torque 312
 - Window curtain air bag** 46
 - Windows**
 - see Side windows
 - Windshield**
 - Defrosting 118
 - Windshield heating**
 - Problem (malfunction) 119
 - Switching on/off 119
 - Windshield washer fluid**
 - Adding 257
 - Indicator lamp 229
 - Windshield wipers**
 - Problem (malfunction) 110
 - Rain and light sensor 107
 - Rear window wiper 108
 - Replacing the wiper blades 108
 - Setting the sensitivity (vehicles with steering wheel buttons and rain/light sensor) 196
 - Switching on/off 107
 - Wiping with windshield washer fluid 107
 - Winter diesel** 323
 - Winter driving**
 - Slippery road surfaces 158
 - Snow chains 289
 - Winter operation**
 - General notes 288
 - Radiator cover 28
 - Winter tires**
 - M+S tires 288
 - Setting a limit speed 155
 - Wiper blades**
 - Cleaning 270
 - Replacing 108
 - Workshop**
 - see Qualified specialist workshop

Protection of the environment

General notes

Environmental note

Daimler's declared policy is one of comprehensive environmental protection.

The objectives are for the natural resources that form the basis of our existence on this planet to be used sparingly and in a manner that takes the requirements of both nature and humanity into account.

You too can help to protect the environment by operating your vehicle in an environmentally responsible manner.

Fuel consumption and the rate of engine, transmission, brake and tire wear are affected by these factors:

- operating conditions of your vehicle
- your personal driving style

You can influence both factors. You should bear the following in mind:

Operating conditions:

- avoid short trips as these increase fuel consumption.
- always make sure that the tire pressures are correct.
- do not carry any unnecessary weight.
- remove roof racks once you no longer need them.
- a regularly serviced vehicle will contribute to environmental protection. You should therefore adhere to the service intervals.
- always have service work carried out at a qualified specialist workshop.

Personal driving style:

- do not depress the accelerator pedal when starting the engine.
- do not warm up the engine when the vehicle is stationary.
- drive carefully and maintain a safe distance from the vehicle in front.
- avoid frequent, sudden acceleration and braking.

- change gear in good time and use each gear only up to $\frac{2}{3}$ of its maximum engine speed.
- switch off the engine in stationary traffic.
- keep an eye on the vehicle's fuel consumption.

Environmental issues and recommendations

When prompted by this Operator's Manual to dispose of materials, please try to regenerate and recycle these materials. Observe all relevant environmental guidelines and regulations when disposing of materials. This helps to protect the environment.

Product information

We recommend original Sprinter parts and conversion parts and accessories that have been approved expressly for the type of vehicle concerned.

We test genuine Sprinter parts, as well as conversion parts and accessories that have been specifically approved for the type of vehicle, for:

- reliability
- safety
- suitability

Despite ongoing market research, Mercedes-Benz is unable to assess other parts. We therefore accept no responsibility for the use of such parts in a Sprinter, even if they have been independently or officially approved.

Genuine Sprinter parts, as well as specifically approved conversion parts and accessories, can be obtained at an authorized Sprinter Dealer. Here you will receive advice about permissible technical modifications, and the parts will be professionally installed.

Operator's Manual

General notes

Before you first drive off, read this Operator's Manual carefully and familiarize yourself with your vehicle.

Please adhere to the information and warning notes in this Operator's Manual for your own safety and to ensure a longer operating duration of the vehicle. Failure to observe the instructions may lead to damage to the vehicle or personal injury.

Damage to the vehicle, caused by not adhering to the instructions, is not covered by the New Vehicle Limited Warranty .

Vehicle equipment

The Operator's Manual describes all models and standard and optional equipment of your vehicle that were available at the time of going to print. Country-specific variations are possible. Note that your vehicle may not be equipped with all of the described functions. This also applies to systems and functions relevant to safety. The equipment in your vehicle may therefore differ from that shown in the descriptions and illustrations. The original purchase contract documentation for your vehicle contains a list of all of the systems in your vehicle.

If you have questions about equipment and operation, consult any authorized Sprinter Dealer.

The Operator's Manual, the Maintenance Booklet and the equipment-dependent operating instructions are important documents and should be kept in the vehicle.

Service and vehicle operation

Maintenance and literature

The Service and Warranty Information Booklet contains detailed information on the types of warranty that your Sprinter is covered by, including:

- New Vehicle Limited Warranty
- Diesel Engine Limited Warranty
- Anti-Perforation Warranty
- Limited Warranty for Restraint Systems (only vehicles that have been sold and registered in the state of Kansas)
- Legally required Emission Performance Warranty

Replacement parts and accessories are subject to the Replacement Part and Accessory Warranty of the dealer mentioned on the inside cover. You can obtain these from any authorized Sprinter dealer.

Maintenance

The Maintenance Booklet and the Service and Warranty Information Booklet describe all necessary maintenance work that should be carried out at regular intervals.

When you take the vehicle to an authorized Sprinter dealer, always be sure to bring the Maintenance/Service/Warranty Information Booklet. Your customer service advisor enters each maintenance service into the Maintenance Booklet for you.

Registering your vehicle

We may ask our authorized Sprinter Dealers to carry out technical inspections on certain vehicles to improve their quality or safety.

We can only inform you about vehicle checks if we have your registration data.

Your registration data is not stored if:

- you did not purchase your vehicle at an authorized Sprinter Dealer.
- your vehicle has never been inspected at an authorized Sprinter Dealer.

It is advisable to register your vehicle with an authorized Sprinter Dealer. Please inform us as soon as possible about any change of address or vehicle ownership.

Operating safety

Important safety notes

WARNING

Exhaust fumes, some of its constituents, and certain vehicle components contain or emit chemicals known to the State of California to cause cancer and birth defects or other heritable genetic damage.

In addition, certain fluids contained in vehicles, and certain products that are used as components, contain chemicals known to the State of California to cause cancer and birth defects or other heritable genetic damage.

Air bags and pyrotechnic Emergency Tensioning Devices (ETDs) and remote control batteries contain perchlorate material, which may require special handling and regard for the environment. Check with your local government's disposal guidelines.

In California, see www.dtsc.ca.gov/HazardousWaste/Perchlorate/index.cfm.

WARNING

If you do not have the prescribed service/maintenance work or any required repairs carried out, this can result in malfunctions or system failures. There is a risk of an accident. Always have the prescribed service/maintenance work as well as any required repairs carried out at a qualified specialist workshop.

WARNING

Modifications to electronic components, their software as well as wiring can impair their function and/or the function of other networked components. In particular, systems relevant to safety could also be affected. As a result, these may no longer function as intended and/or jeopardize the operating safety of the vehicle. There is an increased risk of an accident and injury.

Never tamper with the wiring as well as electronic components or their software. You should have all work to electrical and electronic equipment carried out at a qualified specialist workshop.

WARNING

Flammable material such as leaves, grass or twigs may ignite if they come into contact with hot parts of the exhaust system. There is a risk of fire.

When driving off road or on unpaved roads, check the vehicle's underside regularly. In particular, remove parts of plants or other flammable materials which have become trapped. In the case of damage, contact a qualified specialist workshop.

The general operating permit for your vehicle could be rendered invalid if you carry out modifications to electronic components, their software as well as wiring.

Driving off-road or on construction sites increases the possibility of vehicle damage which may in turn lead to the failure of certain assemblies and systems.

There is a risk of damage to the vehicle if:

- the vehicle makes contact with the ground, e.g. on a high curb or a loose road surface
- you drive too quickly over an obstacle, e.g. a curb or a pothole
- a heavy object hits the underbody or chassis component

In these or similar situations, the vehicle body, the underbody, chassis components, wheels or tires could be damaged even if this

is not visible from the outside. Components that have been damaged in this way can unexpectedly fail or no longer be able to assimilate the loads occurring in the event of an accident. If the underbody paneling is damaged, flammable material, such as leaves, grass or twigs, could collect between the underbody and underbody paneling. These materials could ignite if they remain in contact with hot components of the exhaust system for an extended period. Have the vehicle checked and repaired immediately at a qualified specialist workshop. If you become aware when continuing the journey that driving safety has been effected, stop as soon as possible in accordance with the traffic conditions. In such cases, consult a qualified specialist workshop. Adapt your driving style to the off-road driving conditions. Drive carefully. Have any vehicle damage rectified at a qualified specialist workshop as soon as possible.

Declaration of conformity

Radio-based vehicle components

USA: "The wireless devices of this vehicle comply with Part 15 of the FCC Rules. Operation is subject to the following two conditions: 1) These devices may not cause harmful interference. 2. This device must accept any interference received, including interference that may cause undesired operation. Changes or modifications not expressly approved by the party responsible for compliance could void the user's authority to operate the equipment."

Canada: "The wireless devices of this vehicle comply with Industry Canada license-exempt RSS standard(s). Operation is subject to the following two conditions: 1) These devices may not cause harmful interference, and 2) these devices must accept any interference received, including interference that may cause undesired operation of the device".

Digital speedometer and odometer

Do not modify the vehicle's electronically stored odometer by tampering with the electronics.

If you sell your vehicle, inform the buyer about any changes to the total distance reading, for example after replacing the speedometer. Failure to do so may constitute a punishable offense under national legislation.

Changing the engine power output

! Increases in engine power can:

- change the emission values
- cause malfunctions
- cause consequential damage

The operating reliability of the engine is not guaranteed in all cases.

Any tampering with the engine management system in order to increase the engine power output will lead to the loss of the New Vehicle Limited Warranty and other warranty entitlements.

If you sell the vehicle, inform the purchaser about the changes to the engine power output of the vehicle. If you do not inform the buyer, this may constitute a punishable offense under national legislation.

Diagnostics connections

All diagnostics connections are only intended for the connection of diagnostic equipment at a qualified specialist workshop.

WARNING

If you connect equipment to the diagnostics connection in the vehicle, it may affect the operation of the vehicle systems. As a result, the operating safety of the vehicle could be affected. There is a risk of an accident.

Do not connect any equipment to a diagnostics connection in the vehicle.

⚠ WARNING

Objects in the driver's footwell can restrict the pedal travel or obstruct a depressed pedal.

The operating and road safety of the vehicle is jeopardized. There is a risk of an accident.

Make sure that all objects in the vehicle are stowed correctly, and that they cannot enter the driver's footwell. Install the floor mats securely and as specified in order to ensure sufficient clearance for the pedals. Do not use loose floor mats and do not place floor mats on top of one another.

- !** If the engine is switched off and a device which is connected to the on-board diagnostics connection is being used, the battery may discharge.

Connecting equipment to the diagnostics connections can lead to emissions monitoring information being reset. The possible outcome may be that the vehicle no longer fulfills the emissions laws and regulations. This may be a criminal offense or breach of road traffic regulations in certain countries.

Qualified specialist workshops

An authorized Sprinter Dealer is a qualified specialist workshop. A qualified specialist workshop has the necessary specialist knowledge, tools and qualifications to correctly carry out the work required on the vehicle. This is especially the case for work relevant to safety.

Observe the information in the Maintenance Booklet.

The following work should always be carried out at qualified specialist workshop:

- work relevant to safety
- service and maintenance work
- repair work
- modifications as well as installations and alterations
- work on electronic components

For this reason, we recommend an authorized Sprinter Dealer.

Proper use**⚠ WARNING**

Gases and fluids from substances that constitute a health hazard or react aggressively can escape even from securely closed containers. When transporting such substances in the vehicle interior, your ability to concentrate or your health could be affected during the journey. Malfunctions, short circuits or electrical component system failures may also result. There is a risk of an accident and fire.

Do not store or transport any substances in the vehicle interior which are hazardous to health or react aggressively.

Do not store or transport any substances in the vehicle interior which are hazardous to health or react aggressively.

These include:

- solvents
- fuel
- oils and greases
- cleaning agents
- acids

There are various warning stickers affixed to your vehicle. If you remove warning stickers, others may fail to recognize the dangers. Leave the warning stickers in their original position.

Observe the following information when operating your vehicle:

- the safety information in these instructions
- the "Technical data" section in this Operator's Manual
- traffic rules and regulations
- motor vehicle laws and safety standards

Exhaust gas aftertreatment

The exhaust gas aftertreatment requires a reducing agent known as Diesel Exhaust Fluid (DEF) in order to function correctly. Filling up the DEF tank is usually part of the service scope. DEF consumption depends on operational and driving conditions and it is not necessary to wait until the next scheduled service to replenish the fluid. Fluid should be added regularly to the DEF supply reservoir during vehicle operation or, at the latest, after receiving the first warning message via the on-board computer.

To conform to emission regulations, you must operate the vehicle with DEF and refill the supply regularly. The engine management recognizes attempts to operate the vehicle without DEF, with thinned DEF or with another reducing agent. After previous warning messages, the engine management then prevents a further engine start.

If the DEF level drops below 1.5 US gal (5.5 l), the first warning message is issued and a warning tone sounds. After the message appears for the first time, and under normal driving conditions, the remaining DEF reserve will last for approximately 1000 miles (1600 km) before the next message.

After that, the 0.8 US gal (3.0 l) reserve mark is reached. Once the reserve range has been reached, you will receive the next warning message and you will hear a series of warning tones. After the first message, the DEF reserve will last for approximately 1,200 miles (1,900 km) until the next message is shown. However, you will only be able to start the engine another 16 times.

You should immediately add 2.0 US gal (7.6 l) of DEF (▷ page 150) or have the DEF supply reservoir filled at a qualified specialist workshop.

When the number of remaining engine starts is 0 the engine management prevents the vehicle being driven at a speed exceeding

5 mph (8 km/h). The **Idle Mode** message appears in the multifunction display:

If the  Check Engine indicator lamp lights up, the exhaust gas aftertreatment is faulty or an emission-related malfunction has occurred (▷ page 213). You will then only be able to drive a maximum 50 mi (80 km) before the engine management restricts the number of starts remaining.

If the exhaust gas aftertreatment is faulty, have it checked and repaired at a qualified specialist workshop.

Further information on DEF can be found in the "Refueling" (▷ page 149) and "Service products and capacities" (▷ page 324) sections.

Attachments, bodies, equipment and conversions

General notes

! For safety reasons, have add-on equipment manufactured and installed according to the Sprinter body/equipment mounting directives in force. These body/equipment mounting directives ensure that the chassis and the body form one unit and that maximum operating and road safety is achieved.

We recommend for safety reasons that:

- you carry out no other modifications to the vehicle.
- you obtain the agreement of the distributor named on the inside of the front cover for any deviations from the approved body/equipment mounting directives.

Approval from certified inspection agencies or official approvals cannot rule out risks to your safety.

We recommend that you use genuine Mercedes-Benz parts as well as conversion parts and accessories that have been specifically approved by Mercedes-Benz for the type of vehicle.

These parts have been specially tested to establish their safety, reliability and suitability.

Further information can be obtained at any authorized Sprinter Dealer.

Notes on the radiator

Even seemingly small changes to the vehicle, such as attaching a radiator trim for winter driving, is not permitted. Do not cover up the radiator. Do not use thermal mats, insect protection covers or anything similar.

Otherwise, the values of the diagnostic system may be affected. Some of these values are legally prescribed and must always be correct.

Information on the cargo compartment floor

! The wooden or plastic cargo area floor fitted at the factory is an integral component of the vehicle structure. The vehicle body could be damaged if you have the load area floor removed. This then affects the securing of loads and the maximum loading capacity of the lashing points is no longer guaranteed.

Therefore, do not have the load area floor removed.

Sprinter body/equipment mounting directives

WARNING

The function of systems or components can be affected by conversions or modifications to the vehicle. They might not function properly any more and/or jeopardize the operational safety of the vehicle. There is an increased risk of an accident and injury.

Conversions or modifications should always be carried out at qualified specialist workshop.

If you intend to make modifications to your vehicle, we strongly recommend that you

contact the distributor named on the inside of the front cover. There you will receive all the necessary information and a charge may be levied.

You alone accept the responsibility if body manufacturers or dealers make modifications that affect the final certification of the engine, the vehicle or the equipment. This also applies to the identification and documentation of modifications to the affected vehicle components.

You are responsible for certification and confirmation that:

- all the applicable standards and regulations that are affected by the vehicle modification are met
- the modified vehicle fulfills the vehicle safety standards and emissions laws and regulations
- the modifications or installation of accessories does not affect the safety of the vehicle

We are not responsible for the final certification, product liability or warranty claims which result from the modifications. This applies to:

- the modified components, assemblies or systems
- any resulting noncompliance with any of the emissions laws and regulations or the motor vehicle safety standards
- any consequences arising from the changes that make the vehicle less safe or even render it defective

We do not assume responsibility as the final-stage manufacturer or for the consequential product liability.

Problems with your vehicle

If you should experience a problem with your vehicle, particularly one that you believe may affect its safe operation, we urge you to contact an authorized Sprinter Dealer immedi-

ately to have the problem diagnosed and rectified.

If the problem cannot be rectified to your satisfaction there:

- please discuss the problem with a management representative from the authorized Sprinter Dealer.
- if necessary, contact the distributor named on the inside of the front cover.

Limited Warranty

! Follow the instructions in this Operator's Manual about the proper operation of your vehicle as well as about possible vehicle damage. Damage to your vehicle that arises from culpable contravention of these instructions is not covered by the Limited Warranty of the distributor named on the inside of the front cover.

Data stored in the vehicle

A wide range of electronic components in your vehicle contain data memories.

These data memories temporarily or permanently store technical information about:

- The vehicle's operating state
- Incidents
- Malfunctions

In general, this technical information documents the state of a component, a module, a system or the surroundings.

These include, for example:

- operating conditions of system components, e.g. fluid levels
- the vehicle's status messages and those of its individual components, e.g. number of wheel revolutions/speed, deceleration in movement, lateral acceleration, accelerator pedal position
- malfunctions and defects in important system components, e.g. lights, brakes

- vehicle reactions and operating conditions in special driving situations, e.g. air bag deployment, intervention of stability control systems
- ambient conditions, e.g. outside temperature

This data is of an exclusively technical nature and can be used to:

- assist in recognizing and rectifying malfunctions and defects
- analyze vehicle functions, e.g. after an accident
- optimize vehicle function

The data cannot be used to trace the vehicle's movements.

When your vehicle is serviced, technical information can be read from the event data memory and malfunction data memory.

Services include, for example:

- repair services
- service processes
- warranties
- quality assurance

It is read by employees of the service network (including manufacturers) using special diagnostic devices. More detailed information is obtained from it, if required.

After a malfunction has been rectified, the information is deleted from the malfunction memory or is continually overwritten.

When operating the vehicle, situations are conceivable in which this technical data, in connection with other information (if necessary, under consultation with an authorized expert), could be traced to a person.

Examples include:

- accident reports
- damages to the vehicle
- witness statements

Further additional functions that have been contractually agreed upon with the customer allow certain vehicle data to be conveyed by the vehicle as well. The additional functions

include, for example, vehicle location in case of an emergency.

Cockpit	32
Instrument cluster	34
Steering wheel buttons	37
Center console	37
Overhead control panel	38
Door control panel	39
Further control panels	39

Cockpit

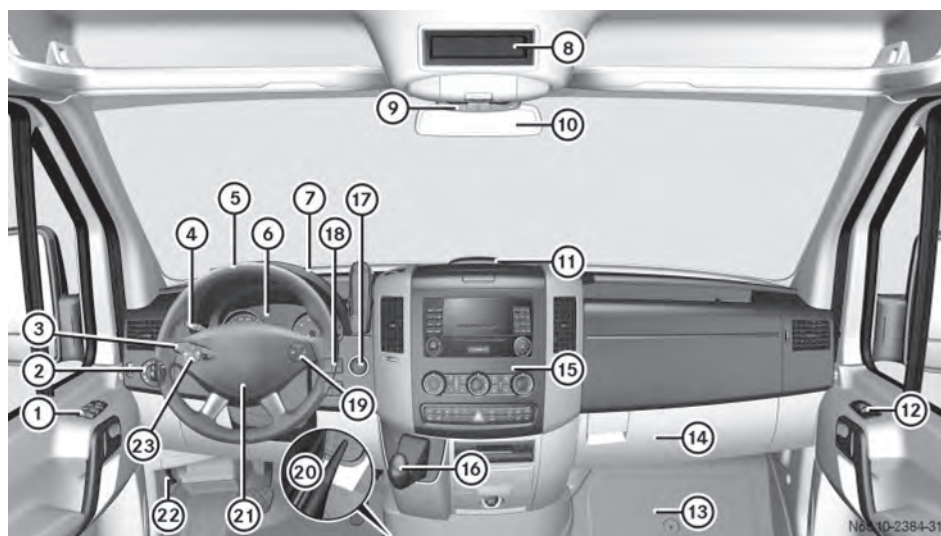

	Function	Page
①	Door control panel	39
②	Light switch Headlamp range adjustment	93 95
③	Combination switch <ul style="list-style-type: none"> • turn signals • high-beam headlamps • windshield wipers • rear window wiper 	95 95 107 108
④	Cruise control lever	161
⑤	Steering wheel without/ with buttons	37
⑥	Instrument cluster	34
⑦	Stowage compartment <ul style="list-style-type: none"> • 3.5 mm audio jack • USB port 	240 240
⑧	Timer for the auxiliary warm-air heater (auxiliary heating)	127

	Function	Page
⑨	• Stowage compartment with interior light • Overhead control panel	98 38
⑩	Rear-view mirror	89
⑪	PARKTRONIC warning display	168
⑫	Opens/closes the right-hand side window	78
⑬	Stowage compartment (jack and vehicle tool kit)	276
⑭	Glove box	232
⑮	Center console	37
⑯	• Selector lever (automatic transmission)	144
⑰	Ignition lock	137
⑱	Further control panels	39
⑲	Steering wheel buttons	37
⑳	Applies/releases the parking brake	157

	Function	Page
⑳	Horn	
㉑	Opens the hood	250
㉒	Steering wheel buttons	37

Instrument cluster

Displays and controls

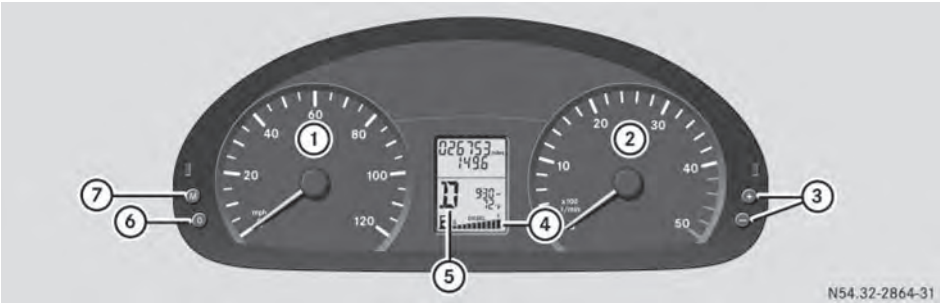

N54.32-2864-31

Instrument cluster on vehicles without steering wheel buttons



N54.32-2865-31

Instrument cluster in vehicles with steering-wheel buttons

	Function	Page		Function	Page
①	Speedometer	183	⑥	Reset button (0)	34
②	Tachometer	183	⑦	Menu button (M)	184 • changes standard display • selects menus
③	(+), (-) Brightens/dims the instrument cluster lighting	183	⑧	Service button (d)	252
④	Fuel gage with fuel filler flap location indicator	183		Checks the engine oil level	
⑤	Display				
	Vehicles without steering wheel buttons	184			
	Vehicles with steering wheel buttons	186			

Indicator and warning lamps



N54.32-2871-31













Instrument cluster on vehicles without steering wheel buttons















N54.32-2872-31

Instrument cluster in vehicles with steering-wheel buttons

	Function	Page		Function	Page
①	Speedometer with warning and indicator lamps			Check Engine indicator lamp	227
	ESP® warning lamp ASR warning lamp	221 221		Preglow Preglow system malfunction	138 228
	Coolant level too low	226	②	Indicator and warning lamps	
	Coolant temperature too high	226			
	Restraint systems malfunction	42		Left-hand turn signal	95
	Brake fluid level too low	222		ABS malfunction	221
	EBD malfunctioning	221		Tire pressure loss or the tire pressure monitor is malfunctioning (USA only) Tire pressure loss (Canada only)	229 294
	Trailer brake force booster malfunction	222			
	Engine oil level warning	225			

	Function	Page
	Fluid level too low in windshield washer/headlamp cleaning system	229
	DEF supply low or contaminated/thinned	184
	Exhaust gas aftertreatment malfunction	224
	Distance warning malfunctioning	59
	Lane Keeping Assist malfunctioning	167
	Door or hood open	230
	Electrically operated step malfunction	230
	Brake pads/linings worn	225
	High-beam headlamps on	95
	Right-hand turn signal	95
	ASR malfunction	60
	BAS malfunction	221
	ESP [®] malfunction	221
	Dirt accumulation in air filter	228

	Function	Page
	Reserve fuel	183
	Fuel filler cap open	227
	Water in the fuel	229
	Battery charging malfunction	225
	Bulb defective	230
	Tachometer with warning and indicator lamps	
	Parking brake applied	157
	Low-beam headlamps on	93
	Working speed governor (ADR) on	172
	High-beam headlamps on	95
	Reserve fuel	227
	Fuel filler cap open	227
	ESP [®] malfunction	221
	Fasten seat belts	230

i Corresponding messages may also be shown in the display (▷ page 199).

Steering wheel buttons



N46.10-2133-31

	Function	Page
①	Display	186
	On-board computer operation	
②	Selects a submenu or adjusts the volume + Up/increases the volume - Down/reduces the volume Using the telephone Accepts a call/starts dialing Ends a call/rejects an incoming call	186 198
③	Scrolls from one menu to another Forwards Back Scrolls within a menu Forwards Back	186 186







Center console



N68.10-2388-31

	Function	Page
①	Stowage compartment	233
②	Audio 10 or Audio 15, see the separate operating instructions	
③	Control panel for the climate control system ¹	112
④	Center console control panel	
	Switches the left/right-hand seat heating on/off	87
	Switches the windshield heating on/off	119
	Switches the rear window defroster on/off	120
	Activates/deactivates PARKTRONIC	170

¹ For vehicles without rear-compartment climate control, a paper holder is attached.

	Function	Page
	Switches the hazard warning lamps on/off	96
	Activates/deactivates ASR	60
 	Central locking, interior/rear compartment	71
	Activating/deactivating the distance warning function	59
	Activates/deactivates Lane Keeping Assist	167
⑧ 	Activates/deactivates Blind Spot Assist	164
⑤	<ul style="list-style-type: none"> • Stowage compartment or • CD changer, see separate operating instructions or 	
⑥	Cup holder with: <ul style="list-style-type: none"> • ashtray • cigarette lighter 	236 237 238
⑦	12 V socket	238

Overhead control panel



	Function	Page
①	Microphone for the mobile phone	239
②	Switches the reading lamp on/off, right	98
③	Switches the automatic interior lighting on/off	98
④	<ul style="list-style-type: none"> • Eyeglasses compartment or • Anti-Theft Alarm system (ATA) 	233 62
⑤	Switches the interior lighting on/off	98
⑥	Switches the reading lamp on/off, left	98

Door control panel







	Function	Page
①	Adjusts the exterior mirrors	89
②	Selects an exterior mirror	89
③	Opens/closes the left-hand side window	78
④	Opens/closes the right-hand side window	78

Further control panels



Control panel between the light switch and the steering wheel



	Function	Page
	Switches the auxiliary heating on/off	124
	Switches the heater booster function on/off	130
	Sets the working speed	172
	Switches the working speed governor (ADR) on/off	172
	Ventilates the cargo compartment	133

Control panel between the steering wheel and the ignition lock



	Function	Page
 	Switches the central rear compartment lighting on/off	98

Useful information	42
Occupant safety	42
Child restraint systems	50
Child-proof locks	54
Pets in the vehicle	56
Driving safety systems	56
Emergency exit	61
Theft deterrent locking system	62

Useful information

This Operator's Manual describes all models as well as standard and optional equipment of your vehicle that were available at the time of going to print. Country-specific variations are possible. Note that your vehicle may not be equipped with all of the described functions. This also applies to systems and functions relevant to safety.

Read the information on qualified specialist workshops (▷ page 26).

Occupant safety

Important safety notes

WARNING

Modifications to the restraint systems could result in them not functioning properly any more. The restraint systems could then no longer protect vehicle occupants as they are designed to do and could fail in the event of an accident or activate unexpectedly, for example. There is an increased risk of injury. Never modify parts of the restraint systems. Do not attempt to modify the wiring as well as electronic components or their software.

If it is necessary to modify an air bag system to accommodate a person with disabilities, contact an authorized Mercedes-Benz center. USA only: for further information contact our Customer Assistance Center at 1-800-FOR-MERCEdes (1800-367-6372).

In this section you will learn the most important facts about the restraint system components of the vehicle.

The restraint system consists of:

- Seat belts
- Child restraint systems
- LATCH-type (ISOFIX) child seat securing system

SRS (Supplemental Restraint System) and the air bag system offer additional protection potential.

Although the systems are independent, their protective functions work in conjunction with one another.

-  For information on infants and children traveling with you in the vehicle as well as restraint systems for infants and children, see the "Children in the vehicle" section (▷ page 50).

SRS (Supplemental Restraint System)

Introduction

SRS consists of:

-  warning lamp
- Air bags
- Air bag control unit with crash sensors
- ETDs for the driver's and co-driver's seat
- Seat belt force limiters
- Seat belt force limiters for the driver's and co-driver seats

SRS reduces the risk of occupants hitting parts of the vehicle interior in the event of an accident. In addition, it can reduce the forces the occupants are subjected to during an accident.

SRS warning lamp

WARNING

If SRS is malfunctioning, child restraint system components may be triggered unintentionally or might not be triggered at all in the event of an accident with a high rate of vehicle deceleration. There is an increased risk of injury, possibly even fatal.

Have SRS checked and repaired immediately at a qualified specialist workshop.

SRS functions are checked regularly when you switch on the ignition and when the engine is running. This allows malfunctions to be detected in good time.

When you switch on the ignition, the **SRS** warning lamp in the instrument cluster lights up for approximately 4 seconds.

A malfunction has occurred if the **SRS** warning lamp:

- does not light up when you switch on the ignition, or
- does not go out within a few seconds of switching on the ignition, or
- lights up again

Safety guidelines for seat belts, Emergency Tensioning Devices (ETDs) and air bags

WARNING

- Damaged seat belts or seat belts that have been subjected to stress in an accident must be replaced and their anchoring points must also be checked. Only use seat belts which have been installed or supplied by a qualified specialist workshop.
- Air bags and pyrotechnic Emergency Tensioning Devices (ETDs) contain perchlorate material, which may require special handling and regard for the environment. Check with your local government's disposal guidelines. California residents, see www.dtsc.ca.gov/HazardousWaste/Perchlorate/index.cfm.
- Air bags and ETDs are designed to function on a one-time-only basis. An air bag or ETD that has deployed must be replaced.
- Do not pass seat belts over sharp edges. They could tear.
- Do not make any modification that could change the effectiveness of the seat belts.
- Do not bleach or dye seat belts as this may severely weaken them. In a crash they may not be able to provide adequate protection.
- No modifications of any kind may be made to any components or wiring of the SRS.
- Do not change or remove any component or part of the SRS.
- Do not install additional paneling, seat covers, badges etc. over the steering wheel hub, co-driver's front air bag cover, out-board sides of the seat backrests, door trim panels, or door frame trims.
- Do not install additional electrical/electronic equipment on or near SRS components and wiring.
- Keep the area between air bags and occupants free of objects (e.g. packages, purses, umbrellas etc.).
- Do not hang items such as coat hangers from the coat hooks or handles over the door. These items may be thrown around in the vehicle and cause head and other injuries when the window curtain air bag is deployed.
- Air bag system components will be hot after an air bag has inflated. Do not touch them.
- Never place your feet on the instrument panel or on the seat. Always keep both feet on the floor in front of the seat.
- Improper repair work creates a risk of rendering the SRS inoperative or causing unintended air bag deployment. Work on the SRS must therefore only be performed by qualified technicians. Please contact a qualified specialist workshop.
- For your protection and the protection of others, when scrapping the air bag unit or ETD, our safety instructions must be followed. These instructions are available from any authorized Sprinter Dealer.
- Given the considerable deployment speed, required inflation volume, and the material of the air bags, there is the possibility of abrasions or other, potentially more serious injuries resulting from air bag deployment.

If you sell your vehicle, we strongly recommend that you inform the subsequent owner that the vehicle is equipped with SRS. Also refer them to the applicable section in the Operator's Manual.

Air bags

Important safety notes

WARNING

To reduce the risk of injury when the front air bags inflate, it is very important for the driver and co-driver to always be in a properly seated position and to wear their respective seat belt.

For maximum protection in the event of a collision always be in normal seated position with your back against the seat backrest. Fasten your seat belt and make sure it is properly positioned on your body.

Since the air bag inflates with considerable speed and force, a proper seating position and correct positioning of the hands on the steering wheel will help to keep you at a safe distance from the air bag. Occupants who are not wearing their seat belt, are not seated properly or are too close to the air bag can be seriously injured or killed by an air bag as it inflates with great force instantaneously:

- Sit with the seat belt properly fastened in a position that is as upright as possible with your back against the seat backrest.
- Move the driver's seat as far back as possible, still permitting proper operation of vehicle controls. The distance from the center of the driver's chest to the center of the air bag cover on the steering wheel must be at least 10 inches (25 cm) or more. You should be able to accomplish this by adjusting the seat and steering wheel. If you have any difficulties, please contact a qualified specialist workshop.
- Do not lean your head or chest close to the steering wheel or instrument panel.
- Keep hands on the outside of the steering wheel rim. Placing hands and arms inside the rim can increase the risk and potential severity of hand/arm injury when the driver front air bag inflates.

- Move the co-driver's seat as far as possible away from the instrument panel when the seat is occupied.
- Occupants, especially children, should never place their bodies or lean their heads in the area of the door where the side impact air bag inflates. This could result in serious injuries or death should the side impact air bag be deployed. Always sit as upright as possible, wear the seat belt properly and use an appropriately sized infant restraint, toddler restraint, or booster seat recommended for the size and weight of the child.
- Children twelve years old and under must never travel on the co-driver's seat. They will otherwise be struck by the co-driver's front air bag when it inflates in a crash. This could result in serious or fatal injury.

Failure to follow these instructions can result in severe injuries to you or other occupants.

If you sell your vehicle, it is important that you make the buyer aware of this safety information. Be sure to give the buyer this Operator's Manual.

WARNING

The air bag parts are hot after the airbag has been deployed. There is a risk of injury.

Do not touch the air bag parts. Have the deployed air bags replaced at a qualified specialist workshop as soon as possible.

-  If the vehicle is still in running condition, have it towed to a qualified specialist workshop.

WARNING

If you modify the air bag covers or affix objects such as stickers to them, the air bags may not function correctly. There is an increased risk of injury.

Never modify the air bag covers or affix objects to them.

The air bag installation locations are identified by the label SRS/AIRBAG or AIRBAG.

- Front air bags (▷ page 45)
- Thoraxbags (▷ page 45)
- Window curtain air bags (▷ page 46)

The air bags are deployed if the air bag control unit detects the need for deployment. Only in the event of such a situation will they provide their supplemental protection.

If the driver and co-driver do not wear their seat belts, it is not possible for the air bags to provide their supplemental protection.

In the event of other types of impacts and impacts below air bag deployment thresholds, the air bags will not deploy. The driver and passengers will then be protected to the extent possible by a properly fastened seat belt. A properly fastened seat belt is also needed to provide the best possible protection in a rollover.

Air bags provide additional protection, but are not a substitute for the seat belts. All vehicle occupants must fasten their seat belts regardless of whether your vehicle is equipped with air bags or not.

If an air bag is deployed, you will hear a bang and a small amount of powder is released briefly. Only in rare cases will the bang affect your hearing. The powder emitted is not generally hazardous to health. The **SRS** warning lamp lights up. If it is safe to do so:

- ▶ Exit the vehicle immediately.

If you are unable to leave the vehicle:

- ▶ Open a window.
You will be able to breathe in fresh air and avoid respiratory problems.

It is important for your safety and that of any passengers to have deployed air bags replaced and to have any malfunctioning air bags repaired. This will help to make sure the air bags continue to perform their protective function for the vehicle occupants in the event of a crash.

Front air bags

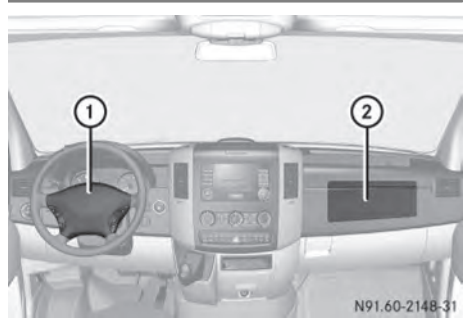

Driver's air bag ① inflates in front of the steering wheel; co-driver's front air bag ② inflates in front of and above the glove box and center console.

The front air bags increase the degree of protection afforded to the driver and co-driver against head and chest injuries.

They are deployed:

- in certain frontal collision situations
- if the system determines that air bag deployment can offer additional protection to that provided by the seat belt
- if the respective seat belt is fastened
- independently of other air bags in the vehicle

If the vehicle rolls over, the front air bags are generally not deployed. The front air bags are deployed if it is detected that the vehicle is decelerating rapidly in the longitudinal direction.

In collision situations with low predicted impact severity the front air bags are not deployed. You will then be protected by the seat belt, provided that it is fastened.

Thoraxbags

WARNING

Only use seat covers which have been tested and approved for your vehicle type by the distributor named on the inside of the front cover. The use of seat covers or other seat coverings may cause a malfunction when the

thoraxbag is deployed. Please contact a qualified specialist workshop for availability.

WARNING

The pressure sensors for controlling the thoraxbags are located in the doors. Do not modify any components of the doors or door trim panels including, for example, the addition of door speakers.

Improperly performed repairs on the doors, modifications to the doors or attached parts can result in the failure or unintentional deployment of the thoraxbag. Work on the doors must therefore only be performed by qualified technicians. Please contact a qualified specialist workshop.



Thoraxbags ① are only installed for individual seats in the outer seat cushions of the driver's and co-driver's seats.

When activated, thoraxbags ① increase protection for the chest area of the occupants facing the impact. However, they do not protect the:

- head
- neck
- arms

Thoraxbags ① are deployed:

- on the side on which the impact occurs
- at the start of an accident with a high rate of lateral vehicle deceleration or acceleration, e.g. in a side impact
- whether or not the seat belt is fastened

- independently of the front air bags
- independently of the Emergency Tensioning Devices

In a side collision with deceleration below the vehicle's pre-set deceleration values or acceleration values, thoraxbags ① are not deployed. You will then be protected by the seat belt, provided that it is fastened.

Window curtain air bags

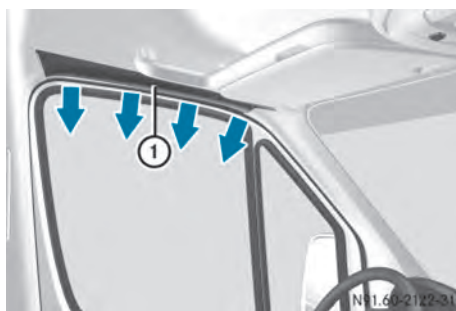

Window curtain air bags ① enhance protection for the head (but not the chest or arms) of the vehicle occupants on the side of the vehicle on which the impact occurs.

The window curtain air bags are installed in the side of the roof frame above the front doors.

Window curtain air bags ① are deployed:

- on the side on which the impact occurs
- at the start of an accident with a high rate of lateral vehicle deceleration or acceleration, e.g. in a side impact
- whether or not the seat belt is fastened
- regardless of whether the co-driver's seat is occupied
- independently of the front air bags
- independently of the Emergency Tensioning Devices

Window curtain air bags will not deploy in impacts which do not exceed the system's preset deployment thresholds for lateral acceleration/deceleration. You will then be protected by the seat belt, provided that it is fastened.

Seat belts

Important safety notes

WARNING

The seat belt does not offer the intended level of protection if the backrest is not in the upright position. When braking or in the event of an accident, you could slide underneath the seat belt and sustain abdomen or neck injuries, for example. This poses an increased risk of injury or even fatal injury.

Adjust the seat properly before beginning your journey. Always make sure that the seat is in the upright position.

Use only seat belts approved for your vehicle by the dealer mentioned on the inside cover page.

WARNING

Always fasten your seat belt before driving off. Always make sure all of your passengers are properly restrained. You and your passengers should always wear seat belts.

Failure to wear and properly fasten and position your seat belt greatly increases your risk of injuries and their likely severity in an accident.

If you are ever in an accident, your injuries can be considerably more severe without your seat belt properly buckled. Without your seat belt buckled, you are much more likely to hit the interior of the vehicle or be ejected from it. You can be seriously injured or killed.

In the same crash, the possibility of injury or death is lessened if you are properly wearing your seat belt. The air bags can only protect as intended if the occupants are properly wearing their seat belts.

WARNING

Never let more people ride in the vehicle than there are seat belts available. Make sure everyone riding in the vehicle is correctly restrained with a separate seat belt. Never

use a seat belt for more than one person at a time.

WARNING

Damaged seat belts or seat belts that have been subjected to stress in an accident must be replaced. Their anchoring points must also be checked.

Only use seat belts which have been approved by the distributor named on the inside of the front cover.

Do not make any modifications to the seat belts. This can lead to unintended activation of the ETDs or to their failure to activate when necessary.

Do not bleach or dye seat belts as this may severely weaken them. In a crash they may not be able to provide adequate protection.

Have all work carried out only by qualified technicians. Please contact a qualified specialist workshop.

The use of seat belts and infant and child restraint systems is required by law in:

- all 50 states
- the U.S. territories
- the District of Columbia
- all Canadian provinces

Even where this is not required by law, all vehicle occupants should correctly fasten their seat belts before starting the journey.

-  For information on infants and children traveling with you in the vehicle as well as restraint systems for infants and children, see the "Children in the vehicle" section (▷ page 50).

Proper use of the seat belts

WARNING

CORRECT USE OF SEAT BELTS

- Seat belts only work properly if they are fastened correctly. Never wear seat belts in any other way than as described in this sec-

tion, as that could result in serious injuries in the event of an accident.

- All occupants should wear their seat belt at all times, because seat belts help reduce the likelihood of and potential severity of injuries in accidents, even if the vehicle rolls over. The integrated restraint system is equipped with SRS (driver's air bag, front-passenger air bag, thorax side impact air bags, window curtain air bags for side windows), Emergency Tensioning Devices and seat belt force limiters.

The system is designed to enhance the protection offered to occupants who are properly secured during certain frontal impacts (front air bags and Emergency Tensioning Devices) and side impacts (thorax side impact air bags, window curtain air bags and Emergency Tensioning Device) that exceed preset deployment thresholds, as well as in certain situations where the vehicle rolls over (window curtain air bags and Emergency Tensioning Device).

- Never route the shoulder section of the seat belt under your arm, across your neck or anywhere other than across your shoulder. In the event of a frontal impact, your body would be moved too far forward. This would increase the risk of head and neck injuries. The seat belt would then apply excessive force to the ribs or abdomen, which could cause severe internal injuries to organs such as the liver or spleen.

Adjust the seat belt so that the upper part of the belt is as close as possible to the center of the shoulder. It should not touch the neck. Never route the belt under the shoulder. The height of the belt outlet can be altered to ensure correct usage.

- The lap belt should be routed as low as possible across the hips, not across the abdomen. If the lap belt is routed across the abdomen, it could cause serious injuries in the event of an impact.

- Never route the seat belt over rigid or fragile objects in or on your clothing, such as eyeglasses, pens, keys etc., as this could cause injuries.
- Always ensure that the seat belt is routed correctly. This is particularly important if you are wearing loose clothing.
- Never use a seat belt for more than one person at a time. Never route a seat belt around more than one person or additional objects.
- Never wear seat belts if they are twisted. Otherwise, in the event of an impact, the full width of the seat belt is unavailable to distribute the force of the impact. The twisted seat belt routed across your body could cause injuries.
- Pregnant women should also always use a three-point seat belt. The lap belt must always pass across your lap as low down as possible, i.e. across your hips; not across your abdomen.
- The backrest should be set as close to vertical as possible.
- Check the seat belt during the journey in order to make sure that it is correctly positioned.
- Never place your feet on the instrument panel or on the seat. Always keep both feet on the floor in front of the seat.
- When using a seat belt to secure an infant restraint system, child restraint system or a child on a booster seat, always follow the child restraint system manufacturer's instructions.

Fastening/unfastening the seat belts

WARNING

According to accident statistics, children are safer when properly restrained on the rear seats than on the front-passenger seat. Thus, we strongly recommend that children be placed in the rear seat whenever possible. Regardless of seating position, children 12 years old and under must be seated and prop-

erly secured in an appropriately sized child restraint system or booster seat recommended for the size and weight of the child. For additional information, see the "Children in the vehicle" section.

A child's risk of serious or fatal injuries is significantly increased if the child restraints are not properly secured in the vehicle and/or the child is not properly secured in the child restraint.

- ❗ **Make sure that the seat belt retracts fully.** The seat belt or belt buckle may otherwise become trapped in the door or the seat adjustment mechanism. This could damage the door, door trim panels and the seat belt. Damaged seat belts can no longer fulfill their protective function and must be replaced at a qualified specialist workshop.

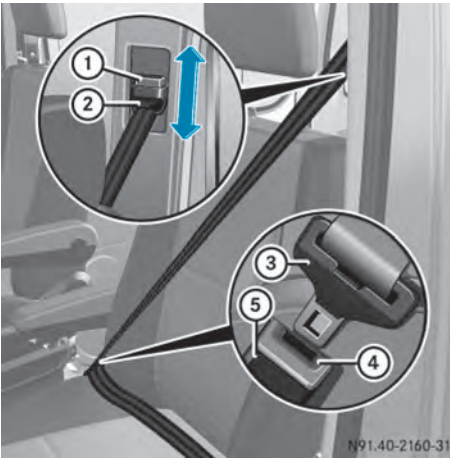

- ▶ **To fasten the seat belt:** adjust the seat and move the backrest to an almost vertical position (▷ page 82).
- ▶ Pull the seat belt smoothly through belt sash guide ②.
- ▶ Without twisting it, guide the shoulder section of the seat belt across the middle of your shoulder and the lap section across your hips.
- ▶ Engage belt tongue ③ in seat belt buckle ⑤.

- ▶ The upper part of the seat belt must be routed across the middle of your shoulder. Adjust the seat belt to the appropriate height as necessary.
- ▶ If necessary, pull upwards on the shoulder section of the seat belt to tighten the belt across your body.
- ▶ **To raise the seat belt:** slide belt sash guide ② upwards.
Belt sash guide ② engages in various positions.
- ▶ **To lower the seat belt:** press and hold release button ①.
- ▶ Adjust belt sash guide ② to the appropriate height.
- ▶ Let go of release button ① and make sure that belt sash guide ② has engaged.
- ▶ **To release the seat belt:** press release button ④ on seat belt buckle ⑤.
- ▶ Guide seat belt to belt sash guide ②.

All seat belts in the vehicle, except the driver's seat belt, are equipped with a special seat belt retractor. This helps to secure the child restraint system properly in the vehicle. For further information on "Special seat belt retractors", see (▷ page 54).

Belt warning for drivers and co-drivers

Regardless of whether the driver's and co-driver's seat belts have already been fastened, the  seat belt warning lamp lights up for six seconds each time the engine is started. It then goes out if the driver and the co-driver have fastened their seat belts. If the driver's seat belt is not fastened when the engine is started, an additional warning tone will sound. This warning tone switches off after approximately six seconds or once the driver's seat belt is fastened.

Emergency Tensioning Devices, seat belt force limiters

WARNING

Pyrotechnic ETDs that were activated must be replaced.

For your safety, when disposing of the pyrotechnic ETDs always follow our safety instructions. These instructions are available from any authorized Sprinter Dealer.

- !** If the front-passenger seat is not occupied, do not engage the seat belt tongue in the buckle on the front-passenger seat. Otherwise, the Emergency Tensioning Device could be triggered in the event of an accident.
- In order to ensure that the pyrotechnic Emergency Tensioning Devices have not been triggered, always have the seat belts checked after an accident.
If the Emergency Tensioning Devices have been triggered, they must be replaced.

If the vehicle is equipped with a driver's air bag, the seat belts on the driver's and co-driver's seats have Emergency Tensioning Devices and seat belt force limiters.

ETDs tighten the seat belts in an accident, pulling them close against the seat occupant's body.

ETDs do not correct incorrect seat positions or incorrectly fastened seat belts.

ETDs do not pull vehicle occupants back towards the backrest.

When activated, the seat belt force limiters reduce the force exerted by the seat belt on the driver or co-driver.

The seat belt force limiters are synchronized with the front air bags, which absorb part of the deceleration force, resulting in the force exerted on the occupant being distributed over a greater area.

The ETDs can only be triggered if the ignition is switched on and the restraint systems are operational, see "**SRS** warning lamp" (> page 42).

The Emergency Tensioning Devices are triggered depending on the type and severity of an accident:

- in the event of a head-on or rear-end collision if the vehicle decelerates or accelerates rapidly in a longitudinal direction during the initial stages of the impact
- in the event of a side impact if the vehicle decelerates or accelerates rapidly in a lateral direction and the vehicle is equipped with thorax side impact air bags and/or window curtain air bags

If the ETDs are triggered, you will hear a bang and powder may also be released. Only in rare cases will the bang affect your hearing. The powder emitted is not generally hazardous to health. The **SRS** warning lamp lights up.

Child restraint systems

Important safety notes

WARNING

If the child restraint system is not installed correctly to a suitable seat, the child may not be secured in the event of an accident or sudden braking and may be seriously or even fatally injured. Therefore, when installing a child restraint system, you must observe the manufacturer's installation instructions as well as the notes on using the child restraint system.

Child restraint systems should preferably be installed to the rear seats. Children are generally better protected there.

Never place objects, e.g. cushions, under the child restraint system. The entire base of the child restraint system must always rest on the seat cushion.

A child restraint system must not be used without the genuine cover designed for it. Only replace damaged covers with genuine covers.

On the rear seats, use only child restraint systems that have been recommended for use in the Sprinter.

 **WARNING**

Accident statistics show that children secured in the rear seats are safer than children secured in the co-driver's seat. For this reason, we strongly advise that you always secure children in the rear seats. Regardless of the seat position, children under 12 years must be secured correctly in a suitable infant or child restraint system or booster seat suitable for the size and weight of the child.

Never place anything between the seat cushion and child seat (e.g. pillow). The bottom of the child seat must make full contact with the vehicle seat cushion. An incorrectly mounted child seat could cause injuries to the child in the event of an accident, instead of protecting the child.

The infant or child restraint must be properly secured with the vehicle's seat belt, the seat belt and Top Tether strap, or lower anchors and Top Tether strap, fully in accordance with the child seat manufacturer's instructions.

Always observe the manufacturer's instructions when installing special child restraint systems.

Occupants, in particular children, must sit as upright as possible, fasten the seat belt correctly and use a suitable infant restraint system, child restraint system or booster seat suitable for the size and weight of the child.

Children can be seriously or even fatally injured by an air bag deploying. Observe the following important information if it is absolutely necessary to carry a child on the co-driver's seat:

- The co-driver's front air bag is not deactivated.
- Never secure your child in a rearward-facing child restraint system on the co-driver's seat. A child in a rearward-facing child restraint system on the co-driver's seat can be seriously injured or even killed if the co-driver's front air bag deploys. Only install a

rearward-facing child restraint system on a suitable rear seat.

- Where permitted by state law, if you secure your child in a forward-facing child restraint system on the co-driver's seat, move the co-driver's seat as far back to the rear as possible. You must then use an appropriately sized child restraint system recommended for the age, size and weight of the child and secure it with the vehicle seat belt in accordance with the child seat manufacturer's instructions.

 **WARNING**

Infants and small children should never share a seat belt with another occupant. In the event of an accident, they could be crushed between the occupant and seat belt.

A child's risk of serious or fatal injuries is significantly increased if the child restraints are not properly secured in the vehicle and/or the child is not properly secured in the child restraint.

Children that are too large for a child restraint must travel in seats using normal seat belts. Position the shoulder belt across the chest and shoulder, not the face or neck. A booster seat may be necessary to achieve proper seat belt positioning for children over 41 lbs (18 kg) until they reach a height where a lap/shoulder belt fits properly without a booster seat.

When the child restraint is not in use, remove it from the vehicle or secure it with the seat belt to prevent the child restraint from becoming a projectile in the event of an accident.

 **WARNING**

When extending or retracting, parts of the body could become trapped within the sweep of the roller sunblind. There is a risk of injury.

When extending or retracting, make sure that no one has any parts of the body within the sweep of the roller sunblind. If someone becomes trapped, briefly press the button

again. The opening or closing procedure will be stopped.

WARNING

If the child restraint system is installed incorrectly or is not secured, it can come loose in the event of an accident, heavy braking or a sudden change in direction. The child restraint system could be thrown about, striking vehicle occupants. There is an increased risk of injury, possibly even fatal.

Always install child restraint systems properly, even if they are not being used. Make sure that you observe the child restraint system manufacturer's installation instructions.

Further information on secure stowage of loads can be found under "Loading guidelines".

If an infant or child is traveling in the vehicle:

- secure the child with a child or infant seat restraint system appropriate to the age and weight of the child
- make sure that the infant or child is properly secured at all times while the vehicle is in motion.

We recommend that you always properly secure all infants and children in an infant or child restraint system for the journey.

The use of seat belts and infant and child restraint systems is required by law in:

- all 50 states
- the U.S. territories
- the District of Columbia
- all Canadian provinces

Infants and children must always be seated in an appropriate infant or child restraint system recommended for the size and weight of the child. This must be properly secured in accordance with the manufacturer's installation instructions for the infant or child seat restraint system.

All infant or child restraint systems must meet the following standards:

- U.S. Federal Motor Vehicle Safety Standards 213 and 225
- Canadian Motor Vehicle Safety Standards 213 and 210.2

A statement by the child restraint manufacturer of compliance with these standards can be found on the instruction label on the child restraint system. You will also find the statement in the instruction manual provided with the child restraint system.

When using any infant restraint, child restraint or booster seat, make sure to carefully read and follow all manufacturer's instructions for installation and use.

Observe the warning labels in the vehicle interior or on the infant or child restraint.

LATCH-type (ISOFIX) child seat securing system

WARNING

Children that are too large for a child restraint must travel in seats using normal seat belts. Position shoulder belt across the chest and shoulder, not face or neck.

A booster seat may be necessary to achieve proper seat belt positioning for children over 41 lb (18 kg) until they reach a height where a lap/shoulder belt fits properly without a booster.

Install the child restraint system in accordance with the manufacturer's instructions.

Attach the child restraint system to both securing rings.

An incorrectly installed child restraint system could come loose during an accident and seriously or even fatally injure the child.

Child restraint systems or child seat securing rings that are malfunctioning or damaged as the result of a collision must be replaced.

These include, for example:

- Top Tether belt
- Seat belts
- LATCH-type (ISOFIX) child seat securing system

! When installing the child restraint system, make sure that the seat belt for the middle seat does not get trapped.

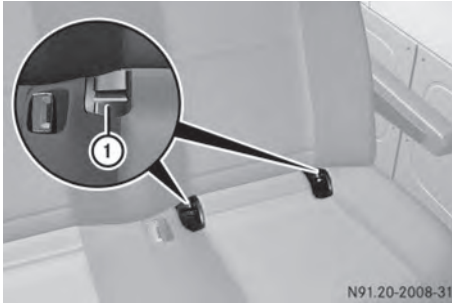

① Securing rings

► Install the LATCH-type (ISOFIX) child restraint system. Comply with the manufacturer's instructions when installing the LATCH-type (ISOFIX) child restraint system.

ISOFIX is a standardized securing system for special child restraint systems on the rear seats. Securing rings ① for the LATCH-type (ISOFIX) child restraint systems are located between the seat cushion and the seat backrest:

- on the outer left and right-hand sides on a narrow rear bench seat with three seats
- on the outer left side on a rear bench seat with two seats

Secure child restraint systems without a LATCH-type (ISOFIX) child seat securing system using the seat belts in the vehicle. When installing child restraint systems, you must observe the manufacturer's installation instructions.

Top Tether

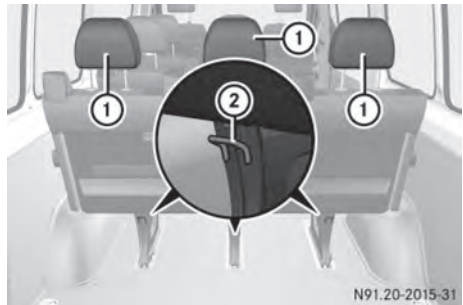

Top Tether anchorage points

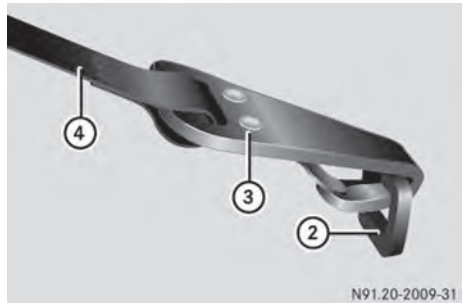

Top Tether belt

Top Tether provides an additional connection between the LATCH-type (ISOFIX) child restraint system and the rear seat. This helps reduce the risk of injury even further.

The Top Tether anchorage points ② are located on the rear side at the bases of the rear bench seats.

- Slide head restraint ① upwards.
- Install the LATCH-type (ISOFIX) child restraint system with Top Tether. Comply with the manufacturer's installation instructions when doing so.
- Route the Top Tether belt ④ under head restraint ① between the two head restraint bars.
- Hook Top Tether hook ③ into Top Tether anchorage ②.

Make sure that:

- the Top Tether hook ③ is hooked into Top Tether anchorage ②, as shown
 - the Top Tether belt ④ is not twisted
- ▶ Tighten Top Tether belt ④. Comply with the manufacturer's installation instructions when doing so.
- ▶ If necessary, push the head restraint back down slightly. Make sure that you do not interfere with the correct routing of Top Tether belt ④.

Special seat belt retractor

WARNING

If the seat belt is released while driving, the child restraint system will no longer be secured properly. The special seat belt retractor is disabled and the inertia reel draws in a portion of the seat belt. The seat belt cannot be immediately refastened. There is an increased risk of injury, possibly even fatal.

Stop the vehicle immediately, paying attention to road and traffic conditions. Reactivate the special seat belt retractor and secure the child restraint system properly.

All seat belts in the vehicle, except the driver's seat belt, are equipped with a special seat belt retractor. When activated, the special seat belt retractor ensures that the seat belt cannot slacken once the child seat is secured.

- ▶ **To activate the special seat belt retractor:** install the child restraint system. Observe the child-seat manufacturer's installation instructions when doing so.
- ▶ Pull the seat belt smoothly from the inertia reel.
- ▶ Engage the belt tongue in the seat belt buckle.

- ▶ Extend the seat belt fully and then allow the inertia reel to retract the belt. A ratcheting noise can be heard when the belt is retracting; this indicates activation of the special seat belt retractor.
- ▶ Press the child restraint system down firmly into the seat to avoid any play.
- ▶ **To disable the special seat belt retractor:** press the seat belt buckle release button and allow the belt to retract fully. The seat belt can be used in the normal manner again.

Child-proof locks

Important safety notes

WARNING

If the child restraint system is subjected to direct sunlight, parts may get very hot. Children may burn themselves on these parts, particularly on the metal parts of the child restraint system. There is a risk of injury.

If you leave the vehicle, taking the child with you, always ensure that the child restraint system is not exposed to direct sunlight. Protect it with a blanket, for example. If the child restraint system has been exposed to direct sunlight, let it cool down before securing the child in it. Never leave children unattended in the vehicle.

You can activate the child-proof lock for the sliding door (▷ page 55) and for the rear door (▷ page 55).

Child-proof locks for the sliding door / rear door

WARNING

If children are traveling in the vehicle, they could:

- open doors, thus endangering other people or road users
- exit the vehicle and be caught by oncoming traffic
- operate vehicle equipment and become trapped

There is a risk of an accident and injury.

Always activate the child-proof locks and override feature if children are traveling in the vehicle. When leaving the vehicle, always take the key with you and lock the vehicle. Never leave children unattended in the vehicle.

The child-proof locks are in the sliding door and rear door.



Child-proof lock for the sliding door



Child-proof lock for the rear door

- ① Latch
- ② Door secured
- ③ Door released

You can use the child-proof locks in the doors to secure the sliding door and the rear door individually.

A door with an activated child-proof lock cannot be opened from the inside. It can only be opened from the outside if the vehicle is unlocked.

- ▶ **To activate/deactivate:** slide latch ① in the corresponding direction.
- ▶ Then, make sure that the child-proof locks are working properly.

Pets in the vehicle

WARNING

If you leave animals unattended or unsecured in the vehicle, they could press buttons or switches, for example.

As a result, they could:

- activate vehicle equipment and become trapped, for example
- activate or deactivate systems, thereby endangering other road users

Unsecured animals could also be flung around the vehicle in the event of an accident or sudden steering or braking, thereby injuring vehicle occupants. There is a risk of an accident and injury.

Never leave animals unattended in the vehicle. Always secure animals properly during the journey, e.g. use a suitable animal transport box.

Driving safety systems

Driving safety systems overview

In this section, you will find information about the following driving safety systems:

- ABS (**A**nti-**l**ock **B**raking **S**ystem)
- BAS (**B**rake **A**ssist **S**ystem)
- ASR (**A**cceleration **S**kid **C**ontrol)
- ESP® (**E**lectronic **S**tability **P**rogram)
- EBD (**E**lectronic **B**rake **F**orce **D**istribution)
- Crosswind Assist
- COLLISION PREVENTION ASSIST

Important safety notes

If you fail to adapt your driving style or if you are inattentive, the driving safety systems can neither reduce the risk of accident nor override the laws of physics. Driving safety systems are merely aids designed to assist driving. You are responsible for the distance to the vehicle in front, for vehicle speed and for

braking in good time. Always adapt your driving style to the prevailing road and weather conditions and maintain a sufficient, safe distance from other road users. Drive carefully.

The driving safety systems described can only attain their maximum effectiveness when there is optimum contact between the tires and the road can. Therefore pay special attention to the information on tires, the recommended minimum tire tread, etc., in the "Wheels and tires" section (▷ page 286).

In wintry driving conditions, always use winter tires (M+S tires) and if necessary, snow chains. Only in this way will the driving safety systems described in this section work as effectively as possible.

ABS (Anti-lock Braking System)

Important safety notes

WARNING

If ABS is faulty, the wheels could lock when braking. The steerability and braking characteristics may be severely impaired. Additionally, further driving safety systems are deactivated. There is an increased danger of skidding and accidents.

Drive on carefully. Have ABS checked immediately at a qualified specialist workshop.

If ABS is malfunctioning, other systems will also fail, including driving safety systems. Observe the information relating to the  warning lamp (▷ page 221).

ABS regulates brake pressure in such a way that the wheels do not lock when you brake. This allows you to continue steering the vehicle when braking.

ABS works from a speed of about 5 mph (8 km/h), regardless of road-surface conditions. ABS works on slippery surfaces, even when you only brake gently.

The yellow  warning lamp in the instrument cluster lights up when the ignition is

switched on. The lamp goes out when the engine starts running.

Braking

If ABS intervenes when braking, you will feel a pulsating in the brake pedal.

The pulsating brake pedal can be an indication of hazardous road conditions and functions as a reminder to take extra care while driving.

- ▶ **If ABS intervenes:** continue to depress the brake pedal with force until the braking situation is over.
- ▶ **To make a full brake application:** depress the brake pedal with full force.

BAS (Brake Assist System)

WARNING

If BAS is malfunctioning, the braking distance in an emergency braking situation is increased. There is a risk of an accident.

In an emergency braking situation, depress the brake pedal with full force. ABS prevents the wheels from locking.

Vehicles without steering wheel buttons: if the BAS driving safety system is malfunctioning, the  warning lamp lights up while the engine is running (▷ page 221).

BAS operates in emergency braking situations. If you depress the brake quickly, BAS automatically increases the brake pressure, thereby reducing the stopping distance.

The brakes will function as usual once you release the brake pedal. BAS is deactivated.

EBD (electronic brake force distribution)

WARNING

If EBD has malfunctioned, the rear wheels can still lock, e.g. under full braking. This increases the risk of skidding and an accident.

You should therefore adapt your driving style to the different handling characteristics. Have the brake system checked at a qualified specialist workshop.

EBD monitors and controls the brake pressure to the rear wheels. This enables EBD to improve handling during braking.

Observe the information on warning and indicator lamps (▷ page 221).

ESP® (Electronic Stability Program)

Observe the important safety guidelines for the driving safety system (▷ page 56).

WARNING

If ESP® is malfunctioning it will not provide any vehicle stabilization. There is an increased risk of skidding or of an accident.

Exercise caution when continuing to drive. Have ESP® checked at a qualified specialist workshop.

! Only operate the vehicle briefly (maximum of 10 seconds) on a brake dynamometer. The key must be turned to position **1** in the ignition lock during this time. You could otherwise damage the drive train or the brake system.

! Do not run the vehicle on a roller dynamometer (e.g. for performance tests). If you must operate the vehicle on a roller dynamometer, please consult a qualified specialist workshop in advance. You could otherwise damage the drive train or the brake system.

If ESP® is malfunctioning, the  warning lamp lights up while the engine is running and the engine power may be reduced (▷ page 221).

Only use wheels with the recommended tire sizes. Only then will ESP® function properly. If you select the drive program **S+** on a vehicle with an AGILITY SELECT switch, ESP® only stabilizes the vehicle to a limited degree.

ESP® therefore permits the vehicle's oversteering and understeering characteristics, which facilitates an extremely sporty driving style. This driving style requires an extremely qualified and experienced driver.

COLLISION PREVENTION ASSIST

COLLISION PREVENTION ASSIST

General notes

COLLISION PREVENTION ASSIST comprises the distance warning function and adaptive Brake Assist.

Distance warning function

Important safety notes

i Note the section on 'Important safety notes' (▷ page 56).

WARNING

The distance warning function does not react:

- to people or animals
- to oncoming vehicles
- to crossing traffic
- when cornering

Thus, the distance warning function cannot provide a warning in all critical situations. There is a risk of an accident.

Always pay careful attention to the traffic situation and be ready to brake.

WARNING

The distance warning function cannot always clearly identify objects and complex traffic situations.

In such cases, the distance warning function may:

- give an unnecessary warning
- not give a warning

There is a risk of an accident.

Always pay careful attention to the traffic situation and do not rely solely on the distance warning function.

Operation

The distance warning function can help you to minimize the risk of a front-end collision with a vehicle ahead or reduce the effects of such a collision. If the distance warning function detects that there is a risk of a collision, you will be warned visually and acoustically. Without your intervention, the distance warning function cannot prevent a collision.

The distance warning function will issue a warning at speeds of around 20 mph (30 km/h) or more if:

- you approach a vehicle ahead of you very quickly. You will then hear an intermittent warning tone and the  warning lamp in the instrument cluster flashes.
- ▶ Brake immediately in order to increase the distance from the vehicle in front.

Or

- ▶ Take evasive action provided it is safe to do so.

If you want the distance warning function to assist you, the function must be activated and operational.

Due to the nature of the system, particularly complicated driving conditions may cause the system to display an unnecessary warning.

With the help of the radar sensor system, the distance warning function can detect obstacles that are in the path of your vehicle for an extended period of time.

From a speed of around 45 mph (70 km/h), the distance warning function can also react to stationary obstacles, such as stopped or parked vehicles.

If you approach an obstacle and the distance warning function detects a risk of a collision, the system will alert you both visually and acoustically.

In particular, the detection of obstacles can be impaired in the case of:

- dirt on the sensors or anything else covering the sensors
- it is snowing or raining heavily

- there is interference from other radar sources
- there are strong radar reflections, for example in parking garages
- a narrow vehicle is traveling in front, e.g. a motorbike
- a vehicle is traveling in front on a different line

Following damage to the front end of the vehicle, have the configuration and operation of the radar sensor checked at a qualified specialist workshop. This also applies to collisions at slow speeds where there is no visible damage to the front of the vehicle.

Activating/deactivating the distance warning function

When you switch on the engine, the distance warning function switches on after a few seconds.

- **To deactivate:** press the  button (▷ page 37).

Vehicles without steering wheel buttons: the  warning lamp in the instrument cluster lights up and the **OFF** message flashes.

Vehicles with steering wheel buttons: the  warning lamp in the instrument cluster lights up and the message **Distance warning deactivated** appears.

- **To activate:** press the  button again (▷ page 37).

Vehicles without steering wheel buttons: the  warning lamp in the instrument cluster goes out and the **ON** message flashes.

Vehicles with steering wheel buttons: the  warning lamp in the instrument cluster goes out and the message **Distance warning activated** appears in the multifunction display.

Adaptive Brake Assist

- i** Observe the "Important safety notes" section for driving safety systems (▷ page 56).

WARNING

Adaptive Brake Assist cannot always clearly identify objects and complex traffic situations.

In such cases, Adaptive Brake Assist may:

- intervene unnecessarily
- not intervene

There is a risk of an accident.

Always pay careful attention to the traffic situation and be ready to brake. Terminate the intervention in a non-critical driving situation.

WARNING

Adaptive Brake Assist does not react:

- to people or animals
- to oncoming vehicles
- to crossing traffic
- to stationary obstacles
- when cornering

As a result, Adaptive Brake Assist may not intervene in all critical conditions. There is a risk of an accident.

Always pay careful attention to the traffic situation and be ready to brake.

Adaptive Brake Assist aids you when braking during hazardous situations at speeds above 20 mph (30 km/h). With the help of the radar sensor system, adaptive Brake Assist can recognize obstacles that are in the path of your vehicle for an extended period of time.

When you approach an obstacle and adaptive Brake Assist detects that there is a risk of a collision, adaptive Brake Assist calculates the braking force necessary to avoid a collision. Should you apply the brakes forcefully, adaptive Brake Assist will automatically increase the braking force to the calculated level.

- Keep the brake pedal depressed until the emergency braking situation is over. ABS prevents the wheels from locking.

The brakes function as usual again if:

- you release the brake pedal
- there is no longer any danger of a collision
- no obstacle is detected in front of your vehicle

Adaptive Brake Assist is then deactivated.

Up to the maximum vehicle speed, adaptive Brake Assist can react to moving obstacles that have already been recognized as such at least once over the period of observation.

Adaptive Brake Assist does not react to stationary obstacles.

In particular, the detection of obstacles can be impaired if:

- dirt on the sensors or anything else covering the sensors
- it is snowing or raining heavily
- there is interference from other radar sources
- there are strong radar reflections, for example in parking garages
- a narrow vehicle is traveling in front, e.g. a motorbike
- a vehicle is traveling in front on a different line

If adaptive Brake Assist is not available due to a malfunction in the radar sensor system, the full brake boosting effect with the help of BAS remains available.

Following damage to the front end of the vehicle, have the configuration and operation of the radar sensor checked at a qualified specialist workshop. This also applies to collisions at slow speeds where there is no visible damage to the front of the vehicle.

ASR (acceleration skid control)

General notes

Important safety notes

ASR can neither reduce the risk of an accident nor suspend the laws of physics if the driver does not pay attention when pulling away or

accelerating. ASR is only an aid. Always adapt your driving style to suit the prevailing road and weather conditions.

Vehicles without steering wheel buttons: if ASR is malfunctioning, the  indicator lamp lights up while the engine is running and the engine power may be reduced (▷ page 221).

ASR significantly improves traction, i.e. the transmission of power from the tires to the road surface, and thus increases the vehicle's driving stability. If the driving wheels start to spin, ASR brakes individual drive wheels and limits the engine torque. ASR thus significantly assists you when pulling away and accelerating, especially on wet or slippery roads.

If traction on the road surface is not sufficient, even ASR will not allow you to pull away without difficulty. The type of tires and total weight of the vehicle as well as the gradient of the road also play a crucial role.

If ASR intervenes, the  warning lamp in the instrument cluster flashes.

Activating/deactivating ASR

WARNING

If deactivated, ASR will not attempt to stabilize the vehicle during pulling away and acceleration. There is an increased risk of skidding and of an accident.



Only deactivate ASR in the situations described in the following.

- ❗ If you deactivate ASR, ESP[®] will still intervene to stabilize the vehicle. Frequent braking automatically triggered by ESP[®] can damage the brake system.

For this reason, deactivate ASR only briefly and when absolutely necessary.



When ESP® is intervening and the  warning lamp in the instrument cluster is flashing, leave ASR on. In this case, only depress the accelerator pedal as far as required when pulling away.

- ▶ Press the  button.
If ASR is deactivated, the  warning lamp in the instrument cluster lights up.

ASR is automatically activated when the engine is started.

It may be best to deactivate ASR briefly in the following situations:

- when using snow chains
- in deep snow
- on sand or gravel

If you deactivate ASR:

- engine torque is not limited and the drive wheels are able to spin. The spinning wheels will then achieve a cutting effect for better traction.
- traction control remains active through brake intervention. If a drive wheel attains its tire traction limit because one side of the road is slippery, for example, that wheel is braked. The traction is then increased in this situation.
- active brake intervention by ESP® to increase driving stability remains active. The  warning lamp in the instrument cluster flashes when ESP® is intervening.

Emergency exit

Emergency exit window

WARNING

The emergency exit window cannot be locked in place. You risk injury if you exit the vehicle through the emergency exit window.

- Make sure that nobody becomes trapped, both when closing and when opening the emergency exit window.
- The opened emergency exit window must be held in place by another person.

Pay attention to traffic conditions.

WARNING

If the emergency exit window is unlocked while driving, it could open and slam shut and consequently fall down. There is a risk of an accident and injury.

Before starting off, make sure that the emergency exit window is locked and the locking pins are undamaged.

- ❗ Make sure there is sufficient clearance when opening the emergency exit window. Hold the open window in position. You could otherwise damage the emergency exit window.

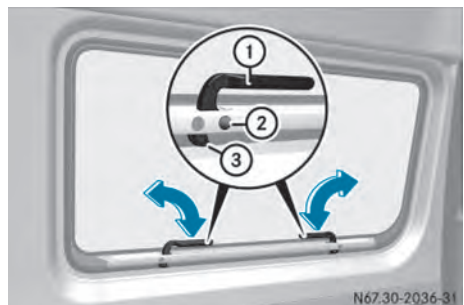

The emergency exit window is intended for use in an emergency only and must not be opened unless the vehicle is stationary. The emergency exit window is the first window behind the driver's seat on the driver's side. It is marked by the "Emergency Exit" label.

- ▶ **To open:** position both handles ① vertically. This will break locking pins ②. The window is unlocked.
- ▶ Swing the window outward by the handles and hold it in this position. Make sure there is sufficient clearance when doing so.
- ▶ **To close:** close the window.
- ▶ Position both handles ① horizontally. Make sure that the locks ③ are inside in front of the window frame. The window is locked.
- ▶ Replace locking pins ② at the latest before starting on a new journey. You can obtain information on this at any qualified specialist workshop.

In an emergency, or after an accident, the vehicle occupants can exit the vehicle through the emergency exit window.

Observe the following notes to make sure that the emergency exit window can be used safely in the event of an emergency:

- Before beginning a journey, inform the vehicle occupants of the emergency exit window and explain how to use it. Make sure to explicitly point out the risks described here.
- Only vehicle occupants who know how to use the emergency exit window are permitted to sit next to it.
- Access to the emergency exit window must remain unobstructed. Do not place any large or heavy objects on or in front of the seats next to the emergency exit window.
- The window handles must not be used as hooks, e.g. to hang up light objects, bags or items of clothing.
- When exiting the vehicle through the emergency exit window, pay attention to the vehicle height and the local conditions. Particularly children and smaller adults may require assistance when exiting the vehicle.

Theft deterrent locking system

Immobilizer

- ▶ **To activate:** remove the key from the ignition lock.
- ▶ **To deactivate:** turn the key to position 2 in the ignition lock.

The immobilizer prevents your vehicle from being started without the correct key.

Always take the key with you and lock the vehicle when leaving the vehicle. If you leave the key in the vehicle, anyone can start the engine.

- ❗ The immobilizer is always deactivated when you start the engine.

In the event that the engine cannot be started when the starter battery is fully charged, the immobilizer may be faulty.

Contact an authorized Sprinter dealer or call 1-877-762-8267 (in USA) or 1-800-387-0100 (in Canada).

ATA (Anti-Theft Alarm system)

- ▶ **To arm:** close all doors.
- ▶ Lock the vehicle with the key. The indicator lamp in the central locking button (▷ page 71) flashes.
- ▶ **To deactivate:** unlock the vehicle with the key. The indicator lamp in the central locking button (▷ page 71) goes out.

- ❗ Cargo Van and Crew Van only:

Unless you open a door or the tailgate within 40 seconds after unlocking the vehicle:

- the vehicle will be locked again
- the anti-theft alarm system will be armed again

If the alarm system is armed, a visual and audible alarm is triggered by the following:

- Unlocking the vehicle from inside
- Opening a door
- Opening the hood

i The alarm is not switched off, even if you immediately close the open door that has triggered it, for example.

▶ **To stop the alarm:** press the  button on the remote control.

Or

▶ Insert the key into the ignition lock.
The alarm stops.

Tow-away alarm

Operation

A visual and audible alarm is triggered if the inclination of the vehicle changes when the tow-away alarm is armed. This can be the case if the vehicle is raised on one side, for example.

Arming/deactivating

The tow-away alarm is automatically armed approximately 20 seconds after you lock the vehicle.

The tow-away alarm is automatically deactivated when you unlock the vehicle.

Deactivating



N54.25-3094-31

▶ Remove the key from the ignition lock.

▶ Press button ①.

When the button is released, the indicator lamp on button ② lights up for about 5 seconds.

▶ Lock the vehicle.

The tow-away alarm is deactivated.

The tow-away alarm remains deactivated until you lock the vehicle again.

Deactivate the tow-away alarm when locking your vehicle and:

- loading and/or transporting the vehicle, on a ferry or car transporter, for example
- parking on a moving surface, as split-level garage

This will prevent false alarms.

Interior motion sensor

Operation

If the armed interior motion sensor detects motion in the vehicle interior, a visual and acoustic alarm is triggered. This can happen if someone reaches into the vehicle interior, for example.

i If the interior motion sensor is armed and the auxiliary heating system (> page 122) switches on, a false alarm may occur as a result of interior temperature monitoring. In this case, either deactivate the interior motion sensor or switch off the auxiliary heating.

Arming

▶ Close the side windows.

▶ Make sure that nothing (such as mascots or coat hangers) are hanging on the rear-view mirror or on the grab handles on the headliner.
This will prevent false alarms.

▶ Lock the vehicle.

The interior motion sensor is armed after approximately 40 seconds.

Switching off

- ▶ Unlock vehicle.
The interior motion sensor automatically switches off.

Deactivating

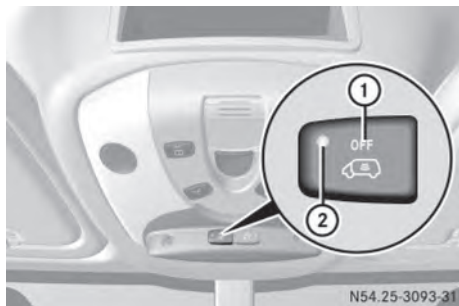

- ▶ Remove the key from the ignition lock.
- ▶ Press button ①.
When the button is released, indicator lamp on button ② lights up for about 5 seconds.
- ▶ Lock the vehicle.
The interior motion sensor is deactivated.

The interior motion sensor remains deactivated until you lock the vehicle again.

Deactivate the interior motion sensor when locking your vehicle:

- with people or animals remaining inside
- with the side windows remaining open
- when transporting it on a ferry or car transporter, for example

This will prevent false alarms.

Useful information	66
Key	66
Central locking	71
Driver's door and co-driver's door	72
Sliding door	72
Electrical step	73
Rear doors	75
Partition sliding door	77
Side windows	78

Useful information

This Operator's Manual describes all models as well as standard and optional equipment of your vehicle that were available at the time of going to print. Country-specific variations are possible. Note that your vehicle may not be equipped with all of the described functions. This also applies to systems and functions relevant to safety.

Read the information on qualified specialist workshops (▷ page 26).

Key

Important safety notes

WARNING

Activate the child-proof door locks if children are traveling in the vehicle. The children could otherwise open the doors while the vehicle is in motion, injuring themselves and others.

WARNING

Do not leave children unsupervised in the vehicle, even if they are secured in a child restraint system. Children could otherwise injure themselves on parts of the vehicle. They could be severely or even fatally injured by prolonged exposure to intense heat or cold.

If children open a door, they could:

- injure other people
- get out of the vehicle and thereby injure themselves or be injured by a passing vehicle
- severely injure themselves by falling down, in particular due to the vehicle height

Always take the key with you when leaving the vehicle, even if you are only leaving for a short time.

WARNING

If you attach heavy or large objects to the SmartKey, the SmartKey could be unintentionally

turned in the ignition lock. This could cause the engine to be switched off. There is a risk of an accident.

Do not attach any heavy or large objects to the SmartKey. Remove any bulky key rings before inserting the SmartKey into the ignition lock.

Do not keep the key with remote control:

- with electronic devices, e.g. a mobile phone or another key with remote control
- with metallic objects, e.g. coins or metal foil
- in metallic objects, e.g. metal cases

This can affect the key's functionality.

Key functions of the remote control

General notes

The vehicle is equipped with either 2 or 4 remote controls with a folding key, or 4 mechanical keys. In this Operator's Manual, both the mechanical keys and the keys with remote control are referred to as keys. The remote control key has a range of up to 32 ft (10 m). Use the remote control of the key only when in immediate proximity of the vehicle. This prevents theft.

Remote controls that are not included in the scope of delivery for the vehicle must be programmed before use. Further information can be obtained at any authorized Sprinter Dealer.

The key's remote control locks/unlocks the driver's door and/or the following centrally if the factory settings have not been changed:

- the driver's and the co-driver's door
- the sliding doors
- the rear doors



i If the driver's or co-driver's door is not closed, the corresponding door is not locked. If a sliding door or a rear door is not closed properly, none of the rear doors are locked.



If there is a key in the ignition lock, the remote control is inoperative. When locking or unlocking the vehicle with the remote control, always pay attention to the indicator lamp signaling. Also check the locking knobs of the doors.

Unlocking/locking the vehicle with the remote control



Remote control with an integrated folding key

- ①  To unlock the sliding doors and the rear door
- ②  To unlock the driver's door only or unlock the vehicle centrally
- ③  To lock the vehicle centrally
- ④ Key release button
- ⑤ Battery check lamp

- ▶ **To unlock the driver's door:** press the  button.
The turn signals flash once. The theft deterrent locking system is deactivated.
- ▶ **To unlock the sliding doors and the rear door:** press the  button.
The turn signals flash once.
- ▶ **To unlock centrally:** unlock the driver's door.
- ▶ Press the  button again within 2 seconds.
The turn signals flash once.
- ❗ If the surround lighting has been switched on using the on-board computer (> page 195), it goes on when the vehicle is unlocked.

If you do not open a Cargo Van or Passenger Van within approximately 40 seconds of unlocking:



- the vehicle is locked again.
- the theft deterrent locking system is armed again.

- ▶ **To lock centrally:** press the  button.
The indicator lamps flash three times when the theft deterrent locking system has been armed and all doors have been closed.
- ▶ Check the locking knobs on all the doors. The locking knobs must all be in the lowered position.

Unlocking/locking the vehicle with the mechanical key or the folding key

The anti-theft alarm system (ATA) is triggered if you unlock and open the driver's door or the rear door with the mechanical key or the folding key.

The alarm can be disabled in the following two ways:

- ▶ Press the  or  button on the remote control.
- Or
- ▶ Insert the key into the ignition lock.

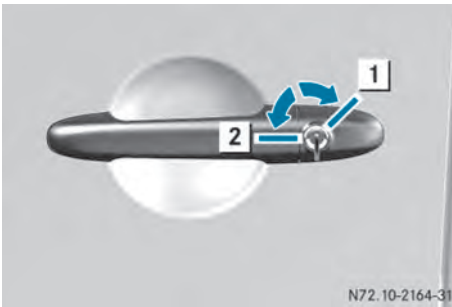

Driver's door

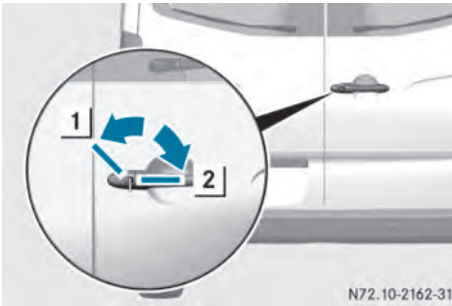

Rear door

- 1 Locked
- 2 Unlocked

- ▶ **To unlock the driver's or rear door:** press the key release button on the remote control.
The key folds out.
- ▶ Insert the key fully into the door lock and turn it to position 2.
The door is unlocked.
- ▶ **To lock the vehicle:** lock all doors except the driver's door and, if necessary the rear door, from inside. To do this, press down the door locking buttons.
- ▶ Press the key release button on the remote control.
The key folds out.
- ▶ Insert the key fully into the driver's door lock and turn it to position 1.
The driver's door is locked.

Remote control battery

Important safety notes

WARNING

Batteries contain toxic and corrosive substances. If batteries are swallowed, it can result in severe health problems. There is a risk of fatal injury.

Keep batteries out of the reach of children. If a battery is swallowed, seek medical attention immediately.

Environmental note



Batteries contain dangerous substances. It is against the law to dispose of them with the household rubbish. They must be collected separately and recycled to protect the environment.





Dispose of batteries in an environmentally friendly manner. Take discharged batteries to a qualified specialist workshop or a special collection point for used batteries.



The key batteries contain perchlorate material, which may require special handling and regard for the environment. Check with your local government's disposal guidelines. California residents, see www.dtsc.ca.gov/HazardousWaste/Perchlorate/index.cfm.

We recommend that you have batteries changed at a qualified specialist workshop.

Checking the batteries

- ▶ Press the  or  button for longer than two seconds.
If battery indicator lamp (▷ page 66) lights up briefly, the batteries in the remote

control still have sufficient charge. Otherwise, change the batteries immediately.

i If the remote control is checked within the signal reception range of the vehicle, pressing the  or  button:

- lock or
- unlock the vehicle

- ▶ Align battery compartment cover ① and push it on until it audibly engages.
- ▶ Check the function of all the remote control buttons on the vehicle.

Changing batteries

You need a CR 2025 2.3 V cell battery, which can be obtained from any qualified specialist workshop.

When changing the batteries, do not press any of the buttons on the remote control.

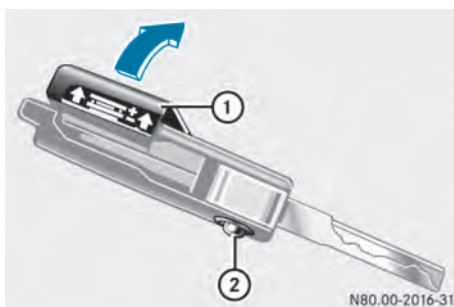



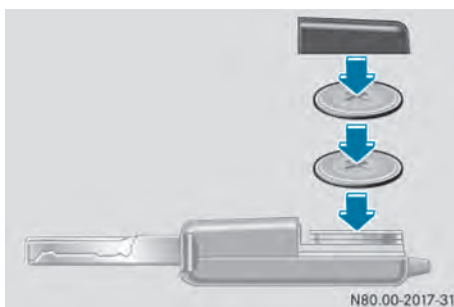

- ▶ Press release button ②. The key folds out.
- ▶ Remove battery compartment cover ① in the direction of the arrow.



- ▶ Remove the batteries from the battery tray.
- ▶ Insert the new batteries into the battery tray with the positive pole facing upwards. Use a lint-free cloth to do so.

Problems with the key/remote control

Problem	Possible causes/consequences and ► Solutions
It is no longer possible to lock the vehicle using the remote control.	The doors are not closed properly. ► Close the doors properly and lock the vehicle again.
	The central locking system has malfunctioned. ► Lock the vehicle using the folding key (▷ page 66). ► Have the central locking system checked as soon as possible at a qualified specialist workshop.
The turn signals do not flash when the vehicle is locked.	The key battery is weak or discharged. ► Point the remote control at the driver's door handle from very close range and press the  or  button.
	If this does not work: ► Replace the key battery (▷ page 69). Or ► Lock the vehicle using the folding key (▷ page 66).
	The remote control is faulty. ► Lock the vehicle using the folding key (▷ page 66). ► Have the key checked at a qualified specialist workshop.
It is no longer possible to lock or unlock the vehicle using the remote control.	The key battery is weak or discharged. ► Point the remote control at the driver's door handle from very close range and press the  or  button. If this does not work: ► Replace the key battery (▷ page 69). Or ► Lock the vehicle using the folding key (▷ page 66).
The key cannot be turned in the ignition lock.	The steering lock has jammed mechanically. ► Remove the key and insert it again into the ignition lock. Turn the steering wheel from side to side while doing so.
The engine cannot be started using the key.	The on-board voltage is too low. ► Switch off all non-essential consumers, such as interior lighting, and try to start the engine again. If this does not work: ► Check the starter battery and charge it if necessary (▷ page 266). Or ► Jump-start the vehicle (▷ page 278). Or ► Consult a qualified specialist workshop.
You have lost a key.	► Have the key deactivated at a qualified specialist workshop. ► Report the loss immediately to the vehicle insurers. ► If necessary, have the mechanical locks replaced.

Central locking

Important safety notes

WARNING

Activate the child-proof door locks if children are traveling in the vehicle. The children could otherwise open the doors while the vehicle is in motion, injuring themselves and others.

WARNING

Do not leave children unsupervised in the vehicle, even if they are secured in a child restraint system. Children could otherwise injure themselves on parts of the vehicle. They could be severely or even fatally injured by prolonged exposure to intense heat or cold.

If children open a door, they could:

- injure other people
- get out of the vehicle and thereby injure themselves or be injured by a passing vehicle
- severely injure themselves by falling down, in particular due to the vehicle height

Always take the key with you when leaving the vehicle, even if you are only leaving for a short time.

You can open a locked front door from the inside at any time. You can open a locked sliding door or rear door from the inside if it has been previously unlocked from inside.

Locking and unlocking manually

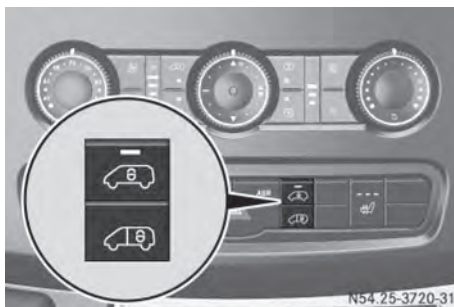



Central locking buttons

Use the central locking buttons to centrally lock/unlock either the entire vehicle or just the sliding doors and rear doors from the inside.

► **To lock/unlock the entire vehicle:** press the upper  central locking button when the doors are closed.

When the entire vehicle is locked, the indicator lamp in the  central locking button lights up.

i If the key has been removed or is in position **0** in the ignition lock, the indicator lamp in the  central locking button remains lit for 5 seconds.

► **To lock/unlock the sliding doors and rear doors:** press the lower section of the  central locking button when the doors are closed.

When the sliding doors and rear doors are locked, the indicator lamp in the upper  central locking button lights up.

Automatic locking

General notes

The vehicle locks automatically as standard once a speed of 9 mph (15 km/h) has been reached. Depending on the vehicle's equipment, the doors may be locked automatically once the ignition is switched on. Information on the functions of the automatic locking

mechanism of your vehicle can be obtained from any authorized Sprinter Dealer.

If the automatic locking when driving function is activated, there is a risk of being locked out when the vehicle is pushed or towed.



For this reason, deactivate the automatic locking when driving function:

- before pushing the vehicle
- before towing the vehicle



If activated, automatic locking is deactivated when the vehicle is unlocked or locked using the central locking button.

Automatic locking is reactivated after the ignition is switched off or a door is opened with the vehicle stationary.

Activating automatic locking when driving

- ▶ Turn the key to position **1** or **2** in the ignition lock when the doors are closed.
- ▶ **For the entire vehicle:** press the upper  central locking button until the indicator lamp in the button flashes four times.
- ▶ **For the sliding doors and rear doors only:** press the  lower central locking button until the indicator lamp in the  upper button flashes four times.

Deactivating automatic locking when driving

- ▶ Turn the key to position **1** or **2** in the ignition lock when the doors are closed.
- ▶ **For the entire vehicle:** press the  upper central locking button until the indicator lamp in the button flashes twice.
- ▶ **For the sliding doors and rear doors only:** press the  lower central locking button until the indicator lamp in the  upper button flashes twice.

Driver's door and co-driver's door

- ⚠ Only open the doors when road and traffic conditions permit. Make sure that there is sufficient clearance when opening the doors. Otherwise, you could damage your vehicle or other vehicles.

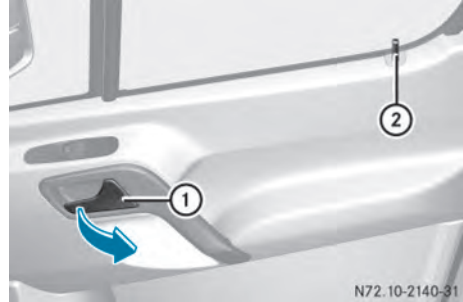

You can open the driver's or co-driver's door from the inside at any time, even if it is locked.

- ▶ Pull door handle ①.
- ▶ Locking knob ② pops up.
- ▶ The door opens.

Sliding door

Important safety notes

WARNING

If the open sliding door is not engaged, it could move on its own if the vehicle is on a slope. This could trap you or other persons. There is a risk of injury.

Always make sure that the open sliding door is engaged.

- ⚠ Only open the doors when road and traffic conditions permit. Make sure that there is sufficient clearance when opening the doors. Otherwise, you could damage your vehicle or other vehicles.

The sliding door of your vehicle can be equipped with an electrical access step. Observe the notes on the electrical step when opening and closing the sliding door (▶ page 73).

Opening/closing from the outside

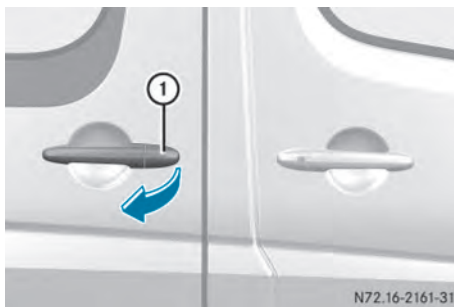

The sliding door is equipped with an active retainer, which engages the door at the end stop when opened.

i You can also lock the sliding door in place around halfway when opening/closing. The door does not have to be opened fully when getting into or out of the vehicle. The intermediate detent does not fully engage the sliding door.

- ▶ **To open:** pull door handle ①.
The sliding door opens.
- ▶ Push back the sliding door using door handle ① until it engages.
- ▶ Check the sliding door detent.
- ▶ **To close:** slide the sliding door firmly forwards by handle ① until it closes.

Opening/closing from the inside

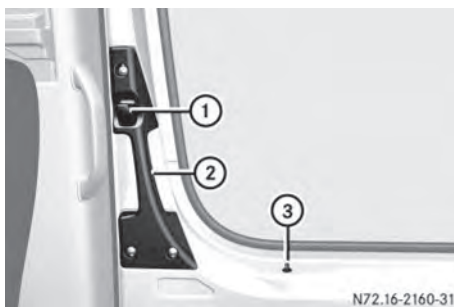

Interior door handle on the sliding door

The sliding door is equipped with an active retainer, which engages the door at the end stop when opened.

You can only open a sliding door from the inside if the child-proof locks have not been activated.

i You can also lock the sliding door in place around halfway when opening/closing. The door does not have to be opened fully when getting into or out of the vehicle. The intermediate detent does not fully engage the sliding door.

- ▶ **To unlock:** pull locking knob ③ upwards.
Only this sliding door unlocks. The other doors remain locked.
- ▶ **To open:** press button ①.
- ▶ Slide the sliding door by handle ② back to the stop.
- ▶ Check the sliding door detent.
The sliding door must be engaged.
- ▶ **To close:** slide the sliding door firmly forwards by handle ② until it engages.
- ▶ **To lock:** press locking knob ③ down.
Only the sliding door is locked. All other doors that were previously unlocked remain unlocked.

Electrical closing assist

If your vehicle is equipped with electrical closing assist, you will require less force to close the sliding door.

Electrical step

Important safety notes

If you do not use the grab handle and the step, you could injure yourself when getting in and out of the vehicle.

In order to reduce risks:

- draw the passengers' attention to the electrical step. Wait until the electrical step is fully extended.
- do not jump out of the vehicle.
- only use the grab handle and step. Only they are designed for such a load.
- keep grab handles, access steps and entry sills free from dirt, e.g. mud, clay, snow and ice.

Operation and obstacle detection



Electrical step

The sliding door of your vehicle can be equipped with an electrical access step.

- ▶ When getting in and out of the vehicle, use the grab handles and electrical step ①.

Electrical step ① automatically extends when the sliding door is opened and retracts when it is closed.

Electrical step ① is equipped with an obstruction detection device on the front side. If the step comes into contact with an obstacle while it is extending, it stops.

After you have removed the obstacle, you must first close the sliding door and open it once again so that the step can extend completely.

- ❗ If the electrical step obstructs loading, you can prevent the step from extending when opening the sliding door via obstacle detection. The electrical step can then remain retracted and a forklift or other lift-

ing equipment can be moved nearer to the cargo compartment.

Vehicles without steering-wheel buttons: if the  indicator lamp in the instrument cluster lights up and a warning tone sounds, electrical step ① is malfunctioning (▷ page 230).

Vehicles with steering-wheel buttons: if the **Electrical Step** message is shown in the display and a warning tone sounds, electrical step ① is malfunctioning (▷ page 219).

If electrical step ① is malfunctioning, the step may only partially extend/retract or may not extend/retract at all. If a malfunction does occur, you will have to retract and lock electrical step ① manually before continuing the journey (▷ page 74).

Before passengers get out of the vehicle, let them know that electrical step ① might not be extended.

Emergency release

- ❗ Driving with the step extended may result in it being damaged.

If the electrical step does not retract automatically, you will have to push it in and lock it into place manually before continuing your journey.

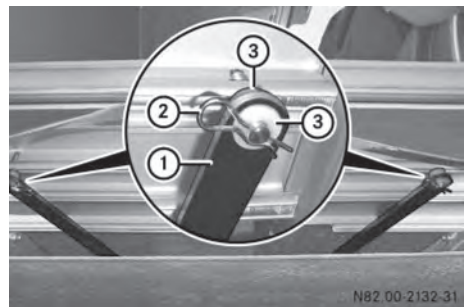

- ▶ Pull R-clips ② on both rods ① on the underside of the step out of their respective pins.
- ▶ Remove washers ③ and detach both rods ①.

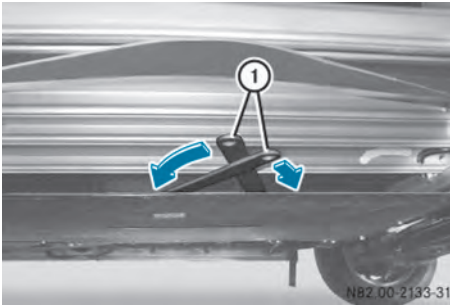

- ▶ Fold rods ① into the housing in the step.
- ▶ Push the step into its housing.

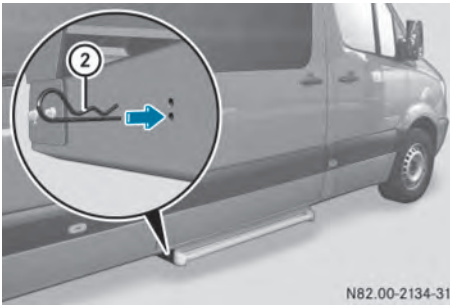

- ① When securing the step for the first time, you must pierce a film with the R-clips.
- ▶ Insert R-clips ② into the step as far as they will go through the holes on both sides of the housing.
The step is secured in its housing.

Rear doors

Important safety notes

⚠ WARNING

If you open a rear door, you could:

- endanger other people or road users
- be caught by oncoming traffic

This is particularly the case if you open the rear door more than 90°. There is a risk of an accident and injury.

Only open the rear doors when traffic conditions permit. Always make sure that the rear doors are properly locked.

⚠ WARNING

If you open the rear doors to 90° (detent position), the rear lamps are no longer visible. The vehicle is no longer sufficiently visible from the rear and will only be recognized as an obstacle at a late stage by other road users. This could lead to an accident.

Therefore, in such a situation, ensure that the vehicle is visible from the rear according to the respective national regulations, e.g. with a warning triangle.

- ❗ Make sure that there is sufficient clearance when opening the rear doors. You could otherwise damage the vehicle and objects in close range of the rear doors.

You can lock the rear doors at an angle of 90°, 180° and 270°. Always make sure that the open rear door is correctly engaged in the detent.

Opening/closing from the outside

Opening the right-hand rear door

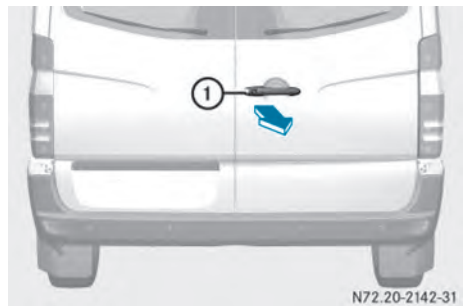

- ▶ Pull handle ①.
- ▶ Swing the rear door to the side until it engages.

Opening the left-hand rear door

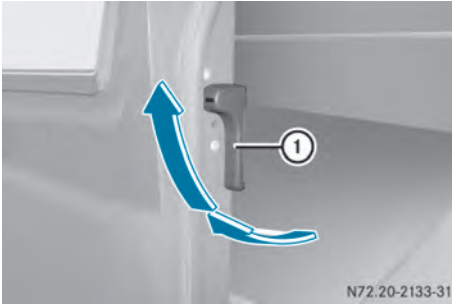

- ▶ Make sure that the right-hand rear door is open and engaged.
- ▶ Pull release handle ① in the direction of the arrow.
- ▶ Swing the rear door to the side until it engages.

Opening the rear doors to an angle of 180° or 270°



Door retainer (example: right rear door)

- ▶ Open the rear door to about 45°.
- ▶ Pull and hold door retainer ① in the direction of the arrow.
- ▶ Open the rear door more than 90°, so that the door retainer cannot engage.
- ▶ Release the door retainer and open the door to an angle of 180° or 270°.

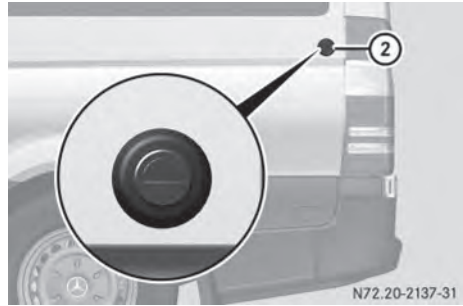

Magnetic door retainer

- ▶ With the rear door opened to an angle of 270°, push it against magnetic door retainer ② on the side wall. When the magnet on the rear door is in contact with magnetic door retainer ②, the rear door is held in this position.

i Vehicles with 270° pivoting rear doors: If door retainer ① malfunctions while loading, you can swivel it 180° against the spring force and onto the door and engage it. The door retainer remains in this position and will not swivel back to its original position.

Before closing the door, release door retainer ① from the detent and return it to its original position.

Closing the rear doors from the outside

- ▶ Pull the rear door away from magnetic door retainer.
- ▶ Close the left-hand rear door firmly from the outside.
- ▶ Close the right-hand rear door firmly from the outside.

Opening/closing from the inside

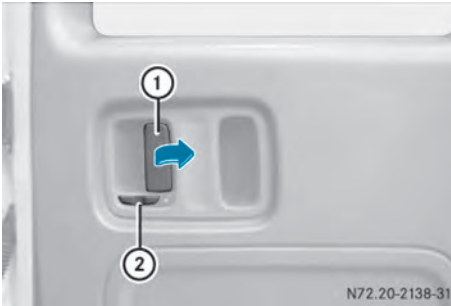

Release the lever on the inside of the right rear door.

A white section on latch ② indicates that the rear door is unlocked.

i You can only open the locked rear doors from the inside if the child-proof locks have not been activated.

- ▶ **To unlock:** slide latch ② to the left. You will see a white marking. Only the rear door unlocks. All other doors that were previously locked remain locked.
- ▶ **To open:** pull opening lever ① and open the unlocked rear door.
- ▶ **To close:** make sure that the left-hand rear door is closed.
- ▶ Pull the rear door firmly by the door handle to close it.
- ▶ **To lock:** slide latch ② to the right. The white section is no longer visible. Only the rear door is locked. All other doors that were previously unlocked remain unlocked.

Partition sliding door

Important safety notes

⚠ WARNING

If the open partition sliding door is not engaged, it could move automatically while the vehicle is in motion. This could trap you or

other persons. There is a risk of an accident and injury.

Close the partition sliding door before every journey and make sure that it is engaged.

Opening/closing the partition sliding door from the cab

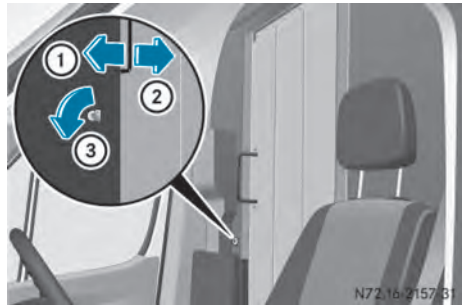

▶ **To open:** turn the key counter-clockwise ③.

The sliding door is unlocked.

▶ Slide the sliding door to the stop in the direction of arrow ②.

▶ **To close:** slide the sliding door in the direction of arrow ① until it engages.

The sliding door can be locked using the key.

Opening/closing the partition sliding door from the cargo compartment

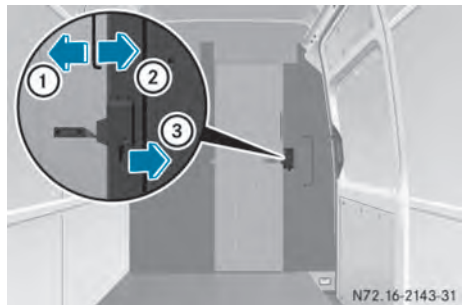

- ▶ **To unlock:** press the catch in the direction of arrow ③.
The sliding door is unlocked.
- ▶ Slide the sliding door to the stop in the direction of arrow ①.
- ▶ **To close:** slide the sliding door in the direction of arrow ② until it engages.

Side windows

Important safety notes

WARNING

While opening the side windows, body parts could become trapped between the side window and the door frame as the side window moves. There is a risk of injury.

Make sure that nobody touches the side window during the opening procedure. If somebody becomes trapped, release the switch or pull the switch to close the side window again.

WARNING

While opening the side windows, body parts in the closing area could become trapped. There is a risk of injury.

Make sure that no body parts are in close proximity during the closing procedure. If somebody becomes trapped, release the switch or press the switch to open the side window again.

WARNING

If children operate the side windows they could become trapped, particularly if they are left unsupervised. There is a risk of injury.

Activate the override feature for the rear side windows. When leaving the vehicle, always take the SmartKey with you and lock the vehicle. Never leave children unsupervised in the vehicle.

WARNING

Do not leave children unsupervised in the vehicle, even if they are secured in a child

restraint system. Children could otherwise injure themselves on parts of the vehicle. They could be severely or even fatally injured by prolonged exposure to intense heat or cold.

If children open a door, they could:

- injure other people
- get out of the vehicle and thereby injure themselves or be injured by a passing vehicle
- severely injure themselves by falling down, in particular due to the vehicle height

Always take the key with you when leaving the vehicle, even if you are only leaving for a short time.

Opening/closing the side window

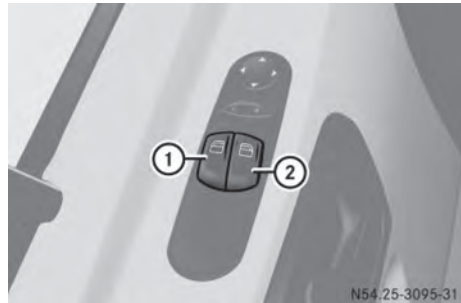

Control panel (example, driver's door)

- ① Power window, left
- ② Power window, right

- ▶ Turn the key to position 2 in the ignition lock.
- ▶ Press or pull button ① or ② until the corresponding side window has reached the desired position.

If you press the switch beyond the pressure point and then release it, the window opens automatically. To stop the movement, press or pull the switch again.

Resetting the side windows

You must reset the side windows if there has been a malfunction or an interruption in the voltage supply.

- ▶ Turn the key to position **2** in the ignition lock.
- ▶ Pull the two power window switches and hold for approximately one second after closing the side window.

Problems with the side windows

If you cannot completely open or close a side window:

If there are no objects or leaves in the window guide that prevent the sliding sunroof from closing, there has been a malfunction or the on-board voltage has been interrupted.

- ▶ Reset the side window (▷ page 79).

Useful information	82
Seats	82
Steering wheel	88
Mirrors	89

Useful information

This Operator's Manual describes all models as well as standard and optional equipment of your vehicle that were available at the time of going to print. Country-specific variations are possible. Note that your vehicle may not be equipped with all of the described functions. This also applies to systems and functions relevant to safety.

Read the information on qualified specialist workshops (▷ page 26).

Seats

Important safety notes

WARNING

If the driver's seat is not engaged, it could move unexpectedly while the vehicle is in motion. This could cause you to lose control of the vehicle. There is a risk of an accident.

Always make sure that the driver's seat is engaged before starting the engine.

WARNING

When you adjust a seat, you or other vehicle occupants could become trapped, e.g. on the seat guide rail. There is a risk of injury.

Make sure when adjusting a seat that no one has any body parts in the sweep of the seat.

WARNING

If head restraints are not installed and adjusted correctly, they cannot provide protection as intended. There is an increased risk of injury in the head and neck area, e.g. in the event of an accident or when braking.

Always drive with the head restraints installed. Before driving off, make sure for every vehicle occupant that the center of the head restraint supports the back of the head at about eye level.

Observe the following points:

- Position the backrest in an almost vertical position so that you are sitting virtually upright. Do not drive with the backrest reclined too far back.
- Your arms should be slightly bent when you are holding the steering wheel.
- Avoid seat positions that prevent the seat belt from being routed correctly. The shoulder section of the belt must be routed over the middle of your shoulder and be pulled tight against your upper body. The lap belt must always pass across your lap as low down as possible, i.e. over your hip joints.
- Adjust the head restraint so that it supports the back of the head at eye level.
- The distance from the pedals should be such that you can depress them fully.

Observe also the safety notes in the section on "Air bags" (▷ page 44) and "Children in the vehicle" (▷ page 50).

If you swap over the head restraints for the front and rear seats, you will not be able to adjust the height and angle of the head restraints to the correct position.

Use the head restraint pad to adjust the head restraint so that it is as close as possible to the back of your head.

Before the journey, make sure the head restraints have been correctly set for each of the vehicle's passengers (▷ page 86).

Your seat must be adjusted in such a way that you can wear the seat belt correctly.

Driver's and co-driver's seat

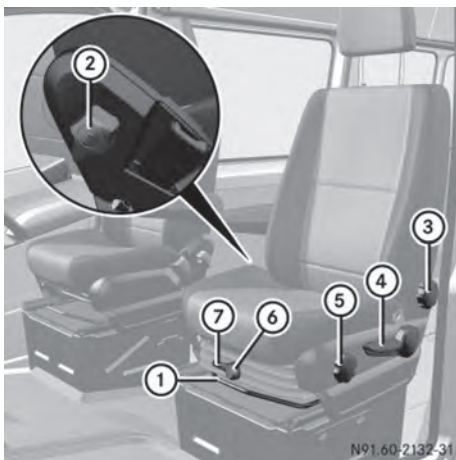

- ① Seat fore-and-aft adjustment
- ② Lumbar support adjustment
- ③ Seat backrest adjustment
- ④ Seat height adjustment
- ⑤ Seat cushion angle adjustment
- ⑥ Seat suspension adjustment
- ⑦ Seat suspension lock

i Depending on the seat model, some adjustments may not be available. You can find information on rotating the front seats under "Swiveling front seats" (> page 84).

- ▶ **To adjust the seat fore-and-aft position:** pull lever ① up.
- ▶ Slide the seat forwards or back until you can depress the pedals.
- ▶ Release lever ①.
- ▶ Slide the seat forwards or back until you hear it engage.
- ▶ **To adjust the backrest:** turn handwheel ③ towards the front. The seat backrest moves to a vertical position.
- ▶ Turn handwheel ③ towards the rear. The seat backrest tilts towards the rear.

▶ **To adjust the seat height:** press or pull lever ④ repeatedly until you have reached the desired seat height.

▶ **To adjust the seat angle:** turn handwheel ⑤ towards the front.

The front of the seat cushion is lowered.

▶ Turn handwheel ⑤ towards the rear.

The front of the seat cushion is raised.

i The lumbar support allows you to use the backrest to increase the support provided to the lumbar spine.

When the lumbar support is correctly adjusted, it reduces strain on your back while driving.

▶ **To adjust the lumbar support:** turn handwheel ② upwards.

This increases the support provided to the lumbar region.

▶ Turn handwheel ② downwards.

This reduces the support provided to the lumbar region.

The seat suspension must be adapted to your body weight. Adjust the seat suspension only while the seat is unoccupied.

▶ **To adjust the seat suspension:** take your weight off the seat.

▶ Using handwheel ⑥, set your body weight (40 to 120 kg) for optimum seat suspension.

The seat suspension will become more rigid the higher you set the weight. It will then not move as far.

If the seat moves up and down frequently and to a great extent, you can lock the seat in the lower movement range.

► **To engage the seat suspension lock:**

turn lever ⑦ upwards.

When it next moves, the seat will lock in position.

i The seat suspension lock will only engage if your body weight equals or exceeds the weight selected for the seat suspension.

► **To release the seat suspension lock:**

turn lever ⑦ to the right.

The seat can now move up and down again.

Swiveling front seats

WARNING

You could lose control of your vehicle if you do the following while driving:

- adjust the driver's seat, head restraint, steering wheel or mirrors
- fasten the seat belt

There is a risk of an accident.

Adjust the driver's seat, head restraint, steering wheel and mirror and fasten your seat belt before starting the engine.

WARNING

If the driver's and co-driver's seats are not engaged facing the direction of travel while driving, the restraint systems may not be able to provide the intended protection. There is an increased risk of injury, possibly even fatal.

Engage the driver's and co-driver's seats so they are facing the direction of travel before starting the engine.

! When rotating the seats, make sure that there is sufficient space to do so.

Move the seat forward or back first. This will help to avoid contact with other parts of the interior.

Push the handbrake lever down to the stop.

The parking brake or handbrake lever could otherwise be damaged.

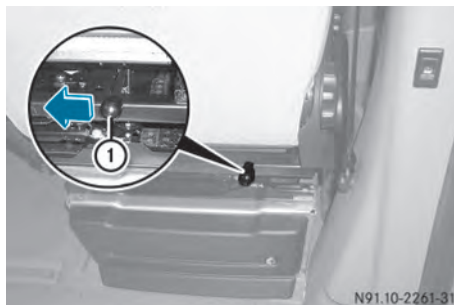

Seat release (example: co-driver's seat)

The driver's seat and co-driver's seat can be rotated by 50° and 180°.

The seats engage when facing in the direction of travel as well as when facing in the opposite direction and also engage at an angle of 50° to the door.

- Make sure that the parking brake has been engaged and that the handbrake lever has been pushed down to the stop (▷ page 152).
- Adjust the steering wheel to provide the necessary space to rotate and adjust the driver's seat (▷ page 88).
- Before rotating, push the co-driver's seat forwards (▷ page 83).
- **2 To rotate the seat:** push lever ① on the rear of the seat towards the center of the vehicle and rotate the seat slightly inwards. The rotation device is released.
- Release lever ①.
- Turn the seat about 50° towards the outside or inside to the desired position.

Twin co-driver's seat



- ▶ **To fold a seat cushion forwards:** lift the seat cushion out of front anchorage ①.
- ▶ Pull the seat cushion forwards slightly and out of rear anchorage ②.
- ▶ Fold the rear edge of the seat cushion up.
 - ❗ You can stow various articles in the space under the twin co-driver's seat.
- ▶ **To fold the seat cushion back:** fold down the seat cushion by the rear edge.
- ▶ Slide the seat cushion under the seat back-rest into rear anchorage ②.
- ▶ Push down on the seat cushion at the front until it engages in front anchorage ①.

Folding seat

⚠ WARNING

If the key is inserted in the partition sliding door, it may come into contact with the person on the folding seat. There is a risk of injury.

Always remove the key from the partition sliding door before a person sits on the folding seat.

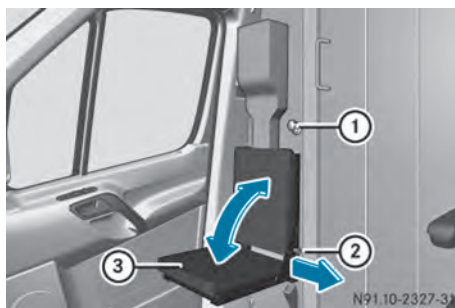

Folding seat (example with partition sliding door)

- ▶ Remove key ① from the partition sliding door.
- ▶ Pull grip ② of the catch in the direction of the arrow and fold seat cushion ③ up or down.
- ▶ Release grip ② of seat cushion ③ in the corresponding end position.
- ▶ Move the seat cushion ③ until it engages. Grip ② of the catch must lie completely on the seat frame.

Rear bench seat (Passenger Van)

⚠ WARNING

If the rear bench seat is not installed as described or an unsuitable rear bench seat is installed, the seat belts may not provide protection as intended. There is an increased risk of injury.

Install the rear bench seat as described. Only use rear bench seats that are approved for your vehicle by the distributor named on the inside cover page.

- ❗ For safety reasons, the four-seat rear bench must only be removed or installed at a qualified specialist workshop.

Keep the seat bench mounting recesses in the vehicle floor free from dirt and foreign objects.

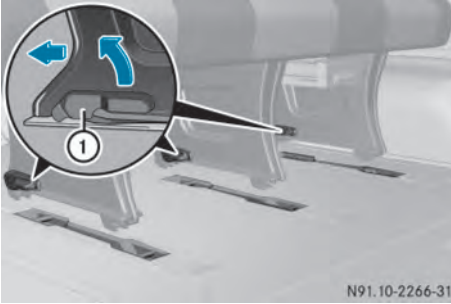

Locking mechanism lever on the feet of the bench seat

- ▶ **To remove the rear bench seat:** swing all levers ① of the bench seat completely upwards. The bench seat moves back into the seat mounting recesses on the vehicle floor.
- ▶ Lift the bench seat upwards out of the seat mounting recesses.

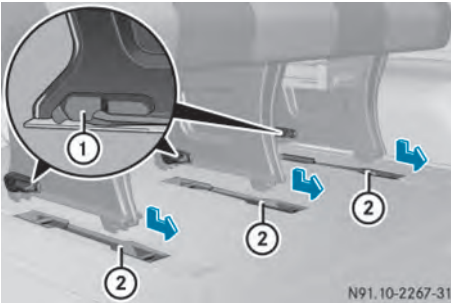

i Do not exceed the maximum permissible number of seats for models registered as passenger vehicles.

- ▶ **To install the rear bench seat:** observe the prescribed installation position of the bench seat. Install the two-seat bench seat only on the driver's side.
- ▶ Check mounting shells ② on the vehicle floor. Mounting shells ② must be free from dirt and foreign objects.
- ▶ Position the bench seat in the direction of travel in corresponding mounting shells ②.

- ▶ Slide the bench seat forwards until you hear the locking mechanisms engage.
- ▶ Check levers ① on the anchorages of the bench seat. All levers ① must be flush to the vehicle floor.

Head restraints

WARNING

If head restraints are not installed and adjusted correctly, they cannot provide protection as intended. There is an increased risk of injury in the head and neck area, e.g. in the event of an accident or when braking.

Always drive with the head restraints installed. Before driving off, make sure for every vehicle occupant that the center of the head restraint supports the back of the head at about eye level.

Do not change over the head restraints for the front and rear seats. Otherwise, it will not be possible to correctly adjust the height and angle of the head restraints.

Adjust the head restraint so that it is as close as possible to the back of your head.

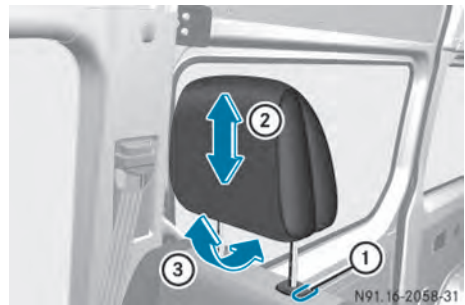

Head restraint (example: luxury head restraint on the co-driver's seat)

- ① Release button
- ② Head restraint height
- ③ Head restraint angle (luxury head restraints only)

- ▶ **To raise:** pull the head restraint up to the desired position.
- ▶ **To lower:** press release button ① and slide the head restraint down to the desired position.
- ▶ **To adjust the angle:** hold the front part of the luxury head restraint by the lower edge and tilt it to the desired position.
- ▶ **To remove:** pull the head restraint up to the stop.
- ▶ Press release button ① and pull out the head restraint.
- ▶ **To insert:** insert the head restraint so that the rod with the detents is on the left when viewed in the direction of travel.
- ▶ Press and hold release button ①.
- ▶ Push the head restraint down until it engages.

Armrests

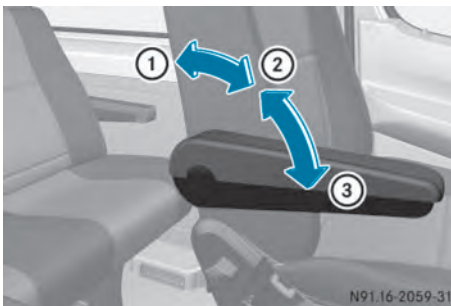

- ▶ **To set the armrest angle:** fold the armrest upwards ② by more than 45°. The armrest is released.
- ▶ Fold armrest ③ forwards to the stop.
- ▶ Slowly fold the armrest upwards to the desired position.
- ▶ **To fold the armrest up:** if necessary, fold the armrest upwards ① by more than 90°.

Seat heating

⚠ WARNING

Repeatedly switching on the seat heating can cause the seat cushion and backrest pads to become very hot. The health of persons with limited temperature sensitivity or a limited ability to react to excessively high temperatures may be affected or they may even suffer burn-like injuries. There is a risk of injury.

Therefore, do not switch the seat heating on repeatedly.

- ❗ When you leave your seat, do not place anything on the seat and switch off the seat heating. Do not switch the seat heating on when the seat is not occupied, e.g. when driving without a co-driver. The seat heating may otherwise overheat, causing damage to the seat.





The three red indicator lamps in the  button show the activated heating level **1** to **3**.

The system automatically switches down from level **3** to level **2** after approximately five minutes.

The system automatically switches down from level **2** to level **1** after approximately ten minutes.

At level **1**, the seat heating remains in continuous operation.

- ▶ Make sure that the key is in position **1** or **2** in the ignition lock.
- ▶ **To switch on:** press the  button repeatedly until the desired heating level has been set.
- ▶ **To switch off:** press the  button repeatedly until all indicator lamps go out.

If the indicator lamps of the current heating level in the  button flash, the seat heating has switched off automatically. In this case, too many electrical consumers are switched on or the battery charge is not sufficient. The seat heating will automatically switch back to the current heating level when enough on-board voltage is available again.

Steering wheel

WARNING

You could lose control of your vehicle if you do the following while driving:

- adjust the driver's seat, head restraint, steering wheel or mirrors
- fasten the seat belt

There is a risk of an accident.

Adjust the driver's seat, head restraint, steering wheel and mirror and fasten your seat belt before starting the engine.

WARNING

If the steering wheel is unlocked while the vehicle is in motion, it could change position unexpectedly. This could cause you to lose control of the vehicle. There is a risk of an accident.

Before starting off, make sure the steering wheel is locked. Never unlock the steering wheel while the vehicle is in motion.

WARNING



Children could injure themselves if they adjust the steering wheel. There is a risk of injury.

When leaving the vehicle, always take the SmartKey with you and lock the vehicle. Never leave children unsupervised in the vehicle.

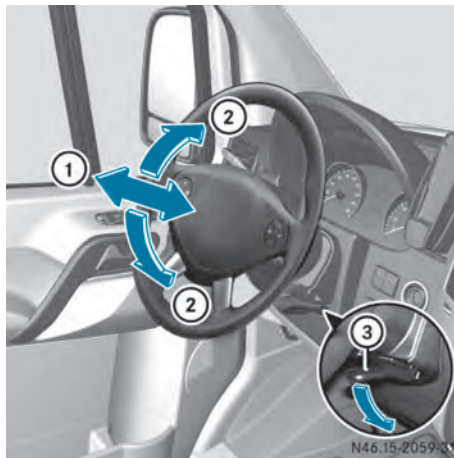
The steering wheel can still be adjusted if the key has been removed.



- ① Steering column fore-and-aft adjustment
- ② Steering column height
- ③ Lever

- ▶ **To set the steering wheel:** swing lever  down until it engages. The steering wheel is unlocked.
- ▶ Move the steering wheel to the desired position.
- ▶ Pull lever  up to the stop. The steering wheel is locked again.

Mirrors

Rear-view mirror



- ▶ **Anti-glare mode:** push anti-glare lever ① in the direction of the arrow.

Exterior mirrors

Important safety notes

WARNING

The additional mirrors in the exterior mirrors reduce the size of the image. Objects visible in the mirrors are closer than they appear. You could misjudge the distance from road users driving behind you when changing lanes, for instance. There is a risk of an accident.

You should therefore always determine the actual distance from road users driving behind you, e.g.:

- by looking over your shoulder
- by looking in the main mirror in the exterior mirror.

Adjusting manually

- ▶ Before starting off, manually adjust the exterior mirrors in such a way that you can get a good overview of road and traffic conditions.

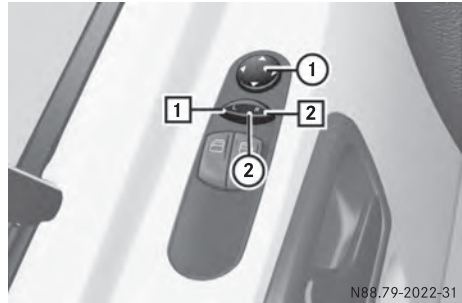

Adjusting electrically



Adjustment buttons and switches for setting the mirrors

- ▶ Before pulling away, turn the key to position **2** in the ignition lock (▶ page 137).
- ▶ Press switch ② to position **1** for the left-hand exterior mirror or to position **2** for the right-hand exterior mirror.
- ▶ Press adjustment button ① at the top, bottom, right or left.

Adjust the exterior mirrors in such a way that you can get a good overview of road and traffic conditions.

-  The exterior mirrors are automatically heated at low outside temperatures.
-  Adjust the wide-angle mirrors by hand.

Useful information	92
Exterior lighting	92
Interior lighting	98
Changing bulbs	100
Windshield wipers	107

Useful information

This Operator's Manual describes all models as well as standard and optional equipment of your vehicle that were available at the time of going to print. Country-specific variations are possible. Note that your vehicle may not be equipped with all of the described functions. This also applies to systems and functions relevant to safety.

Read the information on qualified specialist workshops (▷ page 26).

Exterior lighting

Important safety notes

DANGER

Xenon bulbs carry a high voltage. You can get an electric shock if you remove the cover of the Xenon bulb and touch the electrical contacts. There is a risk of fatal injury.

Never touch the parts or the electrical contacts of the Xenon bulb. Always have work on the Xenon bulbs carried out at a qualified specialist workshop.

WARNING

Bulbs, lamps and connectors can get very hot when operating. If you change a bulb, you could burn yourself on these components. There is a risk of injury.

Allow these components to cool down before changing a bulb.

 Make sure the bulbs are always securely installed.

If your vehicle is equipped with Bi-Xenon bulbs, you can recognize this by the following: the cone of light from the Xenon bulbs moves from the top to the bottom and back again when you start the engine. For this to be observed, the low-beam headlamps must be switched on before starting the engine.

The bulbs and lamps are an essential component of vehicle safety. You must therefore

make sure that these function correctly at all times. Have the headlamp setting checked regularly.

- Always switch off the vehicle's lighting system before changing a bulb.

This will prevent a short circuit.

- Do not touch the glass tube of new bulbs with your bare hands. Always use a clean, lint-free cloth or only touch the base of the bulb when installing.

Even minor contamination can burn into the glass surface and reduce the service life of the bulbs.

- Do not use a bulb that has been dropped or that has scratches on its glass tube.

The bulb could may explode.

- Only use bulbs in closed lamps which have been designed for this purpose.
- Only use spare bulbs of the same type and with the prescribed voltage
- Protect the bulbs from moisture when in use.

If the new bulb still does not light up, consult a qualified specialist workshop.

- Have the LEDs and bulbs of the following lamps changed at a qualified specialist workshop:
 - the additional turn signals in the exterior mirrors
 - the high-mounted brake lamp
 - LED daytime running lamps
 - the Bi-Xenon bulbs
 - front fog lamps

If you require assistance changing bulbs, consult a qualified specialist workshop.

Lamp failure indicator

The bulb failure indicator is only an aid. You are responsible for the proper functioning of the vehicle lighting. Insufficient or non-functioning vehicle lighting puts the operating safety of the vehicle at risk.

For this reason, check the condition and function of your vehicle's lighting system and, if necessary, that of the trailer before each journey.





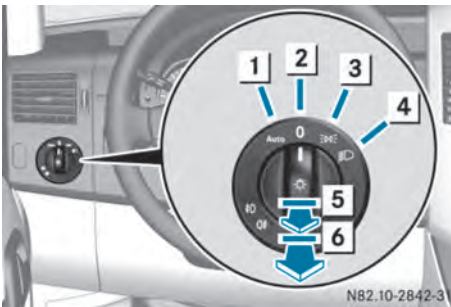

The bulb failure indicator monitors all of the exterior lighting lamps, except the perimeter lamp and the trailer lighting. If a bulb fails, either the  (▷ page 35) indicator lamp lights up, or you will see a corresponding message in the display (▷ page 210).

- i** Depending on the equipment, the bulb failure indicator can fail for all lamps with the exception of the turn signal lamps.

Light switch

Operation



- 1**  Automatic headlamp mode
- 2**  Lights off/daytime running lamp mode
- 3**  Parking lamps, license plate and instrument lighting
- 4**  Low-beam/high-beam headlamps
- 5**  Fog lamps
- 6**  Rear fog lamp

If you hear a warning tone when you leave the vehicle, the lights may still be switched on.



- ▶ Turn the light switch to  or .

Or

- ▶ If the rear fog lamp is switched on: press the light switch in to the stop.

The turn signals, high-beam headlamps and the high-beam flasher are operated using the combination switch (▷ page 95).

Low-beam headlamps

- ▶ **To switch on:** turn the key to position **2** in the ignition lock or start the engine.
- ▶ Turn the light switch to position . The  indicator lamp in the instrument cluster lights up.
- ▶ **To switch off:** turn the light switch to .

Daytime running lamps

You can activate/deactivate the daytime running lamps function using the on-board computer.



This is not possible in countries where daytime running lamps are a legal requirement.

The daytime running lamps function must be activated using the on-board computer:



- vehicles with steering wheel buttons (▷ page 194)
- vehicles without steering wheel buttons (▷ page 185)
- ▶ **To switch on:** turn the light switch to the  position.

The low-beam headlamps, parking lamps and license plate lamp are switched on when the engine is running. The  indicator lamp in the instrument cluster lights up.

- i** USA only:

If you turn the light switch to the  or  position, the parking lamps or low-beam headlamps switch on. If you turn the light switch to the  position, the daytime running lamps remain switched on.

- i** Canada only:

If you turn the light switch to the  position, the low-beam headlamps are switched on. If you turn the light switch to the  position, the parking lamps are switched on.

or **AUTO** position, the daytime running lamps remain switched on.

Automatic headlamp mode

WARNING

When the light switch is set to **AUTO**, the low-beam headlamps may not be switched on automatically if there is fog, snow or other causes of poor visibility due to the weather conditions such as spray. There is a risk of an accident.

In such situations, turn the light switch to .

Automatic headlamp mode is only a driving aid. You are responsible for the vehicle lighting at all times.

Depending on ambient light, the rain and light sensor automatically switches on the parking lamps, low-beam headlamps and the license plate lamp. This excludes weather-related impairments to visibility, such as snow, fog or spray.

If there is fog, snow or spray, turn the light switch quickly from **AUTO** to . You could otherwise briefly interrupt operation of the headlamps.

► **To switch on automatic headlamp mode:** turn the light switch to **AUTO**.

SmartKey in position **1** in the ignition lock: the parking lamps switch on or off automatically depending on the ambient light.

When the engine is running: if you activate the "daytime running lamps" function using the on-board computer, the daytime running lamps are switched on. The parking lamps and low-beam headlamps also switch on or off automatically, depending on the ambient light.



When the low-beam headlamps are switched on, the  indicator lamp in the instrument cluster lights up.







Fog lamp/rear fog lamp

WARNING

If you suspect that driving conditions will be foggy, turn the light switch to  before you start your journey. Your vehicle may otherwise not be visible and you could endanger yourself and others.

WARNING

In low ambient lighting or foggy conditions, only switch from position **AUTO** to  with the vehicle at a standstill in a safe location. Switching from **AUTO** to  will briefly switch off the headlamps. Doing so while driving in low ambient lighting conditions may result in an accident.

- Turn the ignition key to position **2** in the ignition lock or start the engine.
- Turn the light switch to  or .
- i** If your vehicle is only equipped with one rear fog lamp, you must turn the light switch to .
- i** When the light switch is set to **AUTO**, you cannot switch on the front or rear fog lamps.
- **To switch on the front fog lamps:** pull the light switch out to the first locking point. The green  indicator lamp on the light switch lights up.
- **To switch on the rear fog lamp:** pull the light switch out to the second locking point. The yellow  indicator lamp on the light switch lights up.
- **To switch off the front fog lamps/rear fog lamp:** push in the light switch to the stop. The  and  indicator lamp on the light switch go out.

Combination switch

Turn signal lamps

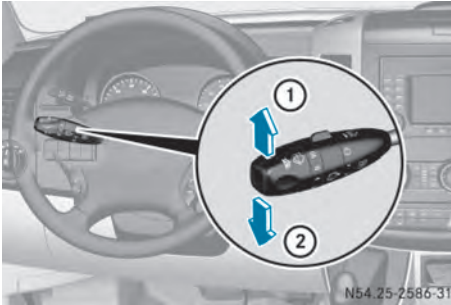

- ① To indicate a right turn
- ② To indicate a left turn

► **To indicate:** press the combination switch in desired direction ① or ② until it engages.

The combination switch automatically returns to its original position after large steering movements.

► **To indicate briefly:** press the combination switch briefly in desired direction ① or ②.

The corresponding turn signal flashes three times.

High-beam headlamps and high-beam flasher

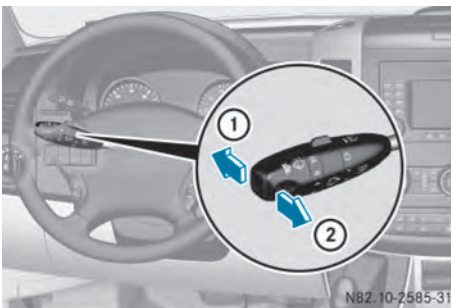

- ① High-beam headlamps
- ② High-beam flasher

► **To switch on the high-beam headlamps:** switch on the low-beam headlamps (▷ page 93).

► Press combination switch ① forwards. The  indicator lamp in the instrument cluster lights up.

i In the **AUTO** position, the high-beam headlamps are only switched on when it is dark and the engine is running.

► **To switch off the high-beam headlamps:** move the combination switch back to its normal position.

The  indicator lamp in the instrument cluster goes out.

► **To switch on the high-beam flasher:** turn the SmartKey to position 1 or 2 in the ignition lock.

► Pull the combination switch briefly in direction of arrow ②.

Headlamp range adjustment



The headlamp range control is used to adapt the downward angle of the headlamp beams in accordance with the load on your vehicle. The cone of light from the headlamps changes if seats are occupied or if the cargo compartment is being loaded or unloaded. This can impair visibility and cause glare to oncoming traffic.

You can only adjust the headlamp range while the engine is running.

- ▶ Turn headlamp range control ① to the corresponding position. The road ahead should be lit up for 40 m to 100 m and the low-beam headlamps should not cause glare to oncoming traffic.
Select position 0 if the vehicle is unladen.

Cornering light function (vehicles with Bi-Xenon headlamps)

The cornering lamps improve the illumination of the road over a wide angle in the direction you are turning, enabling better visibility in tight bends, for example.

The cornering light function switches on automatically, if:

- you are traveling at a speed of less than 25 mph (40 km/h) and you switch on a turn signal or turn the steering wheel.
- you are traveling at a speeds of between 25 mph (40 km/h) and 43 mph (70 km/h) and turn the steering wheel.

The cornering lamp may remain lit for a short time, but is automatically switched off after no more than 3 minutes.

- ⓘ If reverse gear is engaged the lamp on the opposite side of the vehicle switches on instead.

Hazard warning lamps

WARNING

The rear exterior light will be covered if you:

- open the rear doors by 90°
- open the rear dropside.

The vehicle will then be difficult for other road users to see or will not be seen by them at all, particularly if it is dark or visibility is poor. There is a risk of an accident.

You should therefore ensure in this and similar situations that the vehicle is visible from the rear in accordance with the relevant

national regulations, by using the warning triangle, for instance.



Hazard warning lamp switch

- ▶ **To switch on/off:** press the  hazard warning lamp switch.

If you have indicated a turn while the hazard warning lamps are switched on, only the turn signal lamps on the side of the vehicle selected will light up.

The hazard warning lamps switch on automatically if:

- an air bag is deployed.
- you brake sharply and bring the vehicle to a halt from a speed of more than 45 mph (70 km/h).

If the hazard warning lamps have been switched on automatically, press the  hazard warning lamp switch to switch them off.

- ⓘ The hazard warning lamps work even when the ignition is switched off.

Headlamp cleaning system

The headlamps are cleaned automatically with a high-pressure water jet if the "Wipe with washer fluid" function is activated (▷ page 107) while the low-beam headlamps are on and the engine is running.

Information on checking the washer fluid level can be found in the "Maintenance and care" (▷ page 257) section.

Active light function

The active light function is a system that moves the headlamps according to the steering movements of the front wheels. In this way, relevant areas will be illuminated to a greater extent while driving. This allows you to recognize pedestrians, cyclists and animals.

Active: when the lights are switched on.

Highbeam Assist

General notes

You can use this function to set the headlamps to change between high beam and low beam automatically. The system recognizes vehicles with their lights on, either approaching from the opposite direction or traveling in front of your vehicle, and consequently switches the headlamps from high beam to low beam.

Once the system no longer detects any other vehicles, it reactivates the high-beam headlamps.

The system's optical sensor is located behind the windshield near the overhead control panel.

Important safety notes

WARNING

Highbeam Assist does not recognize road users:

- who have no lights, e.g. pedestrians
- who have poor lighting, e.g. cyclists
- whose lighting is blocked, e.g. by a barrier

In very rare cases, Highbeam Assist may fail to recognize other road users who have lights, or may recognize them too late. In this or similar situations, the automatic high-beam headlamps will not be deactivated or will be activated regardless. There is a risk of an accident.



Always carefully observe the traffic conditions and switch off the high-beam headlamps in good time.



Highbeam Assist cannot take into account road, weather or traffic conditions. Highbeam Assist is only an aid. You are responsible for adjusting the vehicle's lighting to the prevailing light, visibility and traffic conditions.

In particular, the detection of obstacles can be restricted if there is:

- poor visibility, e.g. due to fog, heavy rain or snow
- dirt on the sensors or anything else covering the sensors

Activating/deactivating Highbeam Assist



- ▶ **To activate:** switch on the Highbeam Assist function using the on-board computer (▷ page 194).
- ▶ Turn the light switch to the  position.
- ▶ Press the combination switch beyond the pressure point in the direction of arrow  (▷ page 95). Highbeam Assist is active.

The  or  indicator lamp in the multifunction display lights up when it is dark and the light sensor activates the low-beam headlamps.

If you are driving at speeds above approximately 22 mph (35 km/h) and no other road users have been detected:

The high-beam headlamps are switched on automatically. The  indicator lamp in the instrument cluster also lights up.

If you are driving at speeds below approximately 19 mph (30 km/h) other road users are recognized or the roads are adequately lit:

The high-beam headlamps are switched off automatically. The  indicator lamp in the instrument cluster goes out. The  indicator lamp in the instrument cluster goes out.

or  indicator lamp in the multifunction display remains lit.

- ▶ **To deactivate:** move the combination switch back to its normal position or move the light switch to another position.

The  or  indicator lamp in the multifunction display goes out.

Headlamps fogged up on the inside

The headlamps may fog up on the inside if there is high atmospheric humidity.

- ▶ Switch on the low-beam headlamps and drive off. The level of moisture diminishes, depending on the length of the journey and the weather conditions (humidity and temperature).

If the level of moisture does not diminish:

- ▶ Have the headlamps checked at a qualified specialist workshop.

Interior lighting

Switching the dashboard lighting on/off

Overview



Standard interior light

- 1 Interior light switched on
- 2 Interior light switched off
- 3 Automatic control system switched on



Interior lights in the overhead control panel

- 1 To switch the left-hand reading lamp on/off
- 2 To switch the right-hand reading lamp on/off
- 3 Right-hand reading lamp
- 4 Interior light
- 5 To switch the automatic control system on/off
- 6 To switch the interior light on/off
- 7 Left-hand reading lamp

If you switch on the interior light or reading lamp on the overhead control panel manually, it switches off automatically after 20 minutes.

Automatic control

The interior light comes on if you:

- unlock the vehicle
- open the driver's or the co-driver's door
- remove the key from the ignition lock

The interior light switches off again automatically.

If a door is left open, the interior lighting switches off after approximately 20 minutes.

Switching the rear compartment lighting on/off centrally (Passenger Van)



Rear compartment lighting switch

- ① To switch on the rear compartment lighting
- ② Automatic control
- ③ To switch off the rear compartment lighting

You can switch the rear compartment lighting on/off centrally on Passenger Vans that are equipped with convenience control.

There may also be a switch on the rear compartment lights that allows you to switch them on/off separately. If you switch off rear compartment lighting ③, the rear compartment light is switched off, regardless of the position of its own switch.

If you move the rear compartment lighting switch to center position ②, the automatic control system is switched on. When you open a door or unlock the vehicle, the rear compartment lighting then goes on automatically. Once the doors are closed, it switches off automatically after 20 minutes.

If automatic control is switched on, the rear compartment lighting goes on automatically when you unlock the vehicle.

Switching the rear/cargo compartment lamp on/off

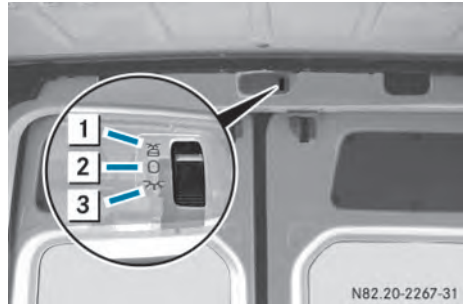

Interior light with switch (example: Cargo Van)



Interior light with switch (example: Passenger Van with rear-compartment air conditioning)

- ① To switch on the interior lighting
- ② To switch off the interior lighting
- ③ Automatic control

For Cargo Vans and Passenger Vans without convenience control, the switch for the interior lighting is on the rear interior light in the cargo compartment/vehicle interior.

If you move the switch to automatic control, the rear/cargo compartment lamps go on when you open a door or unlock the vehicle. It switches off automatically after 20 minutes, or when you close the doors.

Motion detector

WARNING

The motion detector sends the invisible infrared radiation emitted by LEDs (light emitting diodes).

These LEDs are classified as class 1M lasers and can damage the retina if you:

- look directly into the unfiltered laser beam of the motion detector for an extended period
- look directly into the laser beam of the motion detector using optical instruments, e.g. eyeglasses or a magnifying glass.

There is a risk of injury.

Never look directly into the motion detector.

The cargo compartment lighting is also switched on by the motion detector in the cargo compartment of Cargo Vans equipped with this feature.

If the motion detector detects a movement in the cargo compartment when the vehicle is stationary, the cargo compartment lighting switches on for approximately two minutes.

The cargo compartment lighting can be switched on by the motion detector within four seconds if:

- the rear interior light switch (▷ page 99) is set to automatic control.
- the vehicle is stationary, the parking brake is applied and the brake pedal is not being depressed

Or

- the selector lever is in position **P** on vehicles with automatic transmission and the brake pedal is not being depressed and
- the vehicle has not been locked from the outside using the key

The motion detector switches off automatically if no change is detected in the vehicle for several hours, e.g. if a door is opened, if the ignition key is turned, etc. This prevents the battery from becoming discharged.

Changing bulbs

Important safety notes

DANGER

Xenon bulbs carry a high voltage. You can get an electric shock if you remove the cover of the Xenon bulb and touch the electrical contacts. There is a risk of fatal injury.

Never touch the parts or the electrical contacts of the Xenon bulb. Always have work on the Xenon bulbs carried out at a qualified specialist workshop.

WARNING

Bulbs, lamps and connectors can get very hot when operating. If you change a bulb, you could burn yourself on these components. There is a risk of injury.

Allow these components to cool down before changing a bulb.

- Make sure the bulbs are always securely installed.

If your vehicle is equipped with Bi-Xenon bulbs, you can recognize this by the following: the cone of light from the Xenon bulbs moves from the top to the bottom and back again when you start the engine. For this to be observed, the low-beam headlamps must be switched on before starting the engine.

The bulbs and lamps are an essential component of vehicle safety. You must therefore make sure that these function correctly at all times. Have the headlamp setting checked regularly.

- Always switch off the vehicle's lighting system before changing a bulb. This will prevent a short circuit.
- Do not touch the glass tube of new bulbs with your bare hands. Always use a clean, lint-free cloth or only touch the base of the bulb when installing.

Even minor contamination can burn into the glass surface and reduce the service life of the bulbs.

- Do not use a bulb that has been dropped or that has scratches on its glass tube. The bulb could may explode.
- Only use bulbs in closed lamps which have been designed for this purpose.
- Only use spare bulbs of the same type and with the prescribed voltage
- Protect the bulbs from moisture when in use.

If the new bulb still does not light up, consult a qualified specialist workshop.

- Have the LEDs and bulbs of the following lamps changed at a qualified specialist workshop:
 - the additional turn signals in the exterior mirrors
 - the high-mounted brake lamp
 - the Bi-Xenon bulbs
 - front fog lamps

If you require assistance changing bulbs, consult a qualified specialist workshop.

Front bulbs

Overview of bulb types

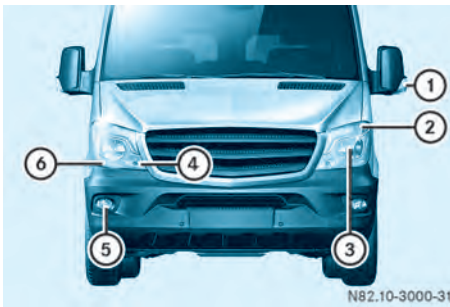

	Lights	Bulb type
①	Additional turn signal lamp in the exterior mirror (not for all-wheel-drive vehicles)	PY16W P2 1W
②	Halogen headlamps Turn signal lamps	PY2 1W

	Lights	Bulb type
	Bi-Xenon headlamps Turn signal lamps	NAK 3457
③	Halogen headlamps	
	Navigation lights	W5W
	Low-beam/high-beam headlamps	H7 55 W
	Bi-Xenon headlamps	
	Low-beam/high-beam headlamps	D3S-35 W
④	Halogen headlamps Daytime running lamps	W21W
	Bi-Xenon headlamps Cornering lamps	H7 55 W
⑤	Fog lamps	H7 55 W
⑥	Bi-Xenon headlamps LED daytime running lamps	W5W 55 W

Low-beam headlamps and high-beam headlamps/cornering lamp

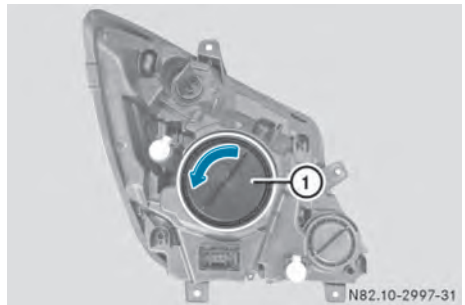

- ▶ Switch off the lighting system.
- ▶ Open the hood (▷ page 250).
- ▶ Turn housing cover ① in the direction of the arrow and remove it.

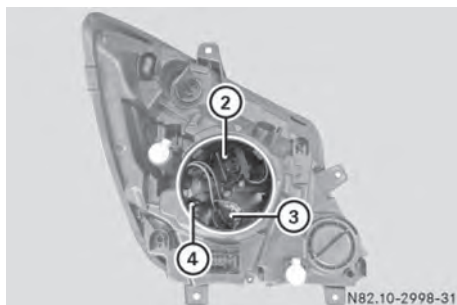

- ② Connector for low-beam headlamps
- ③ Connector for high-beam headlamps
- ④ Connector for navigation lights (halogen headlamps)

- ▶ Remove corresponding connector ②, ③ or ④ from the bulb.
- ▶ Detach the locking spring and remove the bulb.
- ▶ Insert the new bulb in such a way that its base fits into the recess of the bulb holder.
- ▶ Attach the locking spring and plug the connector onto the bulb.
- ▶ Place housing cover ① into the opening and turn in the opposite direction of the arrow.
- ▶ Close the hood.

Cornering light function/daytime running lamps

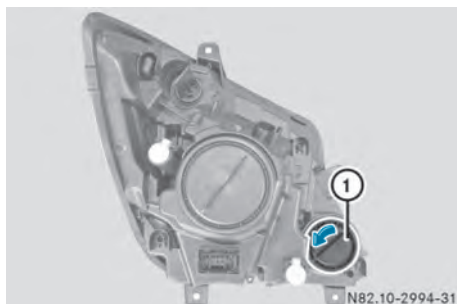

- ▶ Switch off the lighting system.
- ▶ Open the hood (> page 250).
- ▶ Turn housing cover ① counter-clockwise and remove it.

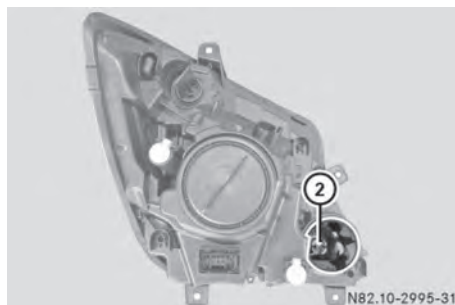

- ▶ Pull out the bulb holder together with bulb ②.
- ▶ Pull the bulb out of the bulb holder.
- ▶ Press a new bulb into the bulb holder.
- ▶ Insert the bulb holder into the lamp.
- ▶ Position housing cover ① and turn it clockwise as far as it will go.
- ▶ Close the hood.

Turn signal lamps

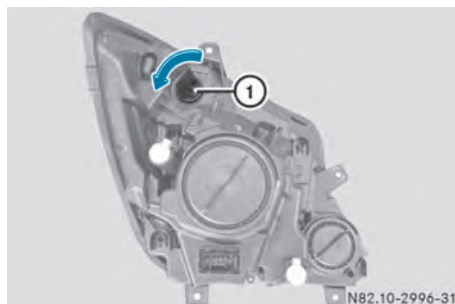

- ▶ Switch off the lighting system.
- ▶ Open the hood (> page 250).
- ▶ Turn bulb holder ① counter-clockwise and remove it.
- ▶ Applying light pressure to the bulb, turn it counter-clockwise and remove it from bulb holder ①.
- ▶ Press the new bulb into bulb holder ① and screw it in clockwise.
- ▶ Insert bulb holder ① into the lamp and turn it clockwise to tighten.
- ▶ Close the hood.

Rear bulbs (Cargo Van/Passenger Van)

Overview of bulb types

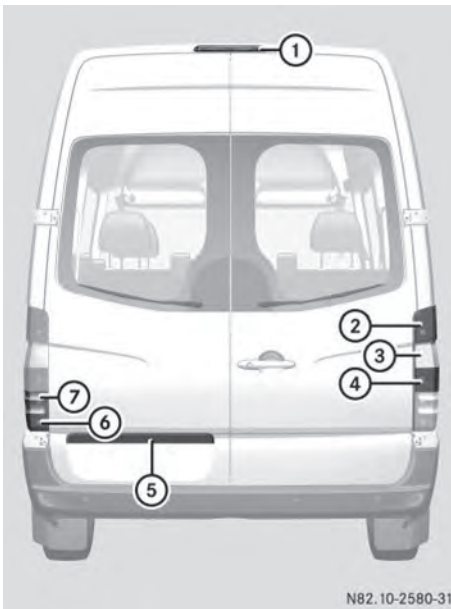

N82.10-2580-31

	Lights	Bulb type
①	High-mounted brake lamp	LED
②	Brake lamps	P 21 W
③	Turn signal lamps	PY 21 W
④	Tail lamps/standing lamps	R 5 W
⑤	License plate lamp	W 5 W
⑥	Rear fog lamps (driver's side)	P 21 W
⑦	Backup lamps	P 21 W

Tail lamps

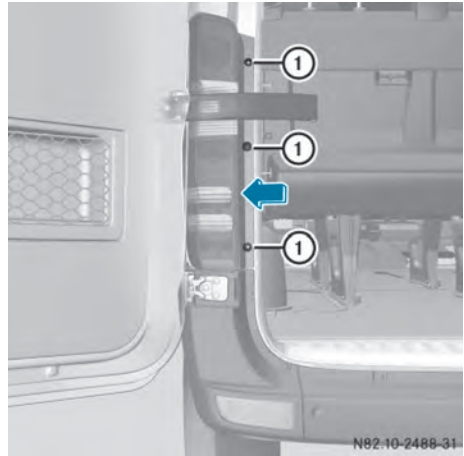

N82.10-2488-31

- ▶ Switch off the lighting system.
- ▶ Open the rear door.
- ▶ Undo screws ① and unclip the lamp lens in the direction of the arrow.
- ▶ Pull the connector off the bulb holder.

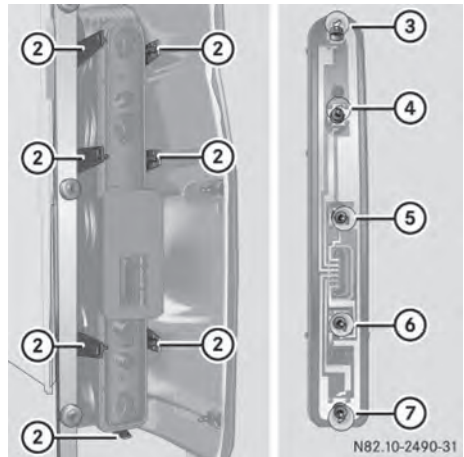

N82.10-2490-31

- ② Retaining lugs
- ③ Brake lamps
- ④ Turn signal lamps
- ⑤ Standing lamp/tail lamp
- ⑥ Backup lamps
- ⑦ Rear fog lamp

- ▶ Release retaining lugs ② and take the bulb holder out of the tail lamp.
- ▶ Applying light pressure to the bulb, turn it counter-clockwise and remove it from the bulb holder.
- ▶ Press the new bulb into the bulb holder and screw it in clockwise.
- ▶ Press the connector into the bulb holder.
- ▶ Insert the lamp lens.

To do this, clip the bulb holder into the three holes provided at the side and tighten screws ①.

License plate lamp

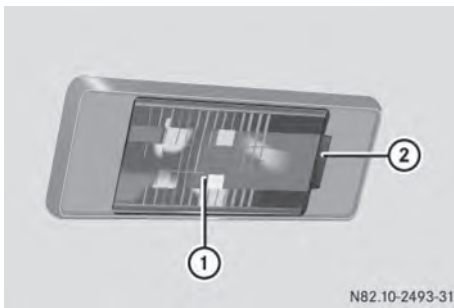

- ▶ Switch off the lighting system.
- ▶ Insert a screwdriver or similar implement into recess ② and carefully pry off lamp lens ①.
- ▶ Pull the bulb out of the bulb holder.
- ▶ Insert a new bulb.
- ▶ Align lamp lens ① and clip it in so that it engages.

Rear bulbs (Cab Chassis)

Overview of bulb types

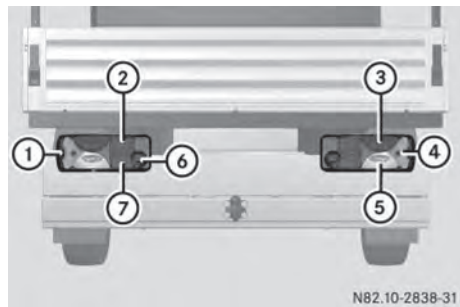

Chassis (example: Cab Chassis)

	Lights	Bulb type
①	Perimeter lamp/standing lamp	R 5 W
②	Tail lamps	R 5 W
③	Brake lamps	P 21 W
④	Turn signal lamps	PY 21 W
⑤	Backup lamps	P 21 W
⑥	Rear fog lamps (driver's side)	P 21 W
⑦	License plate lamp	R 5 W

Tail lamps

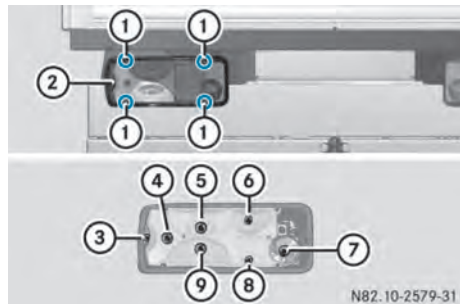

- ① Screws
- ② Lamp lens
- ③ Perimeter lamp/standing lamp
- ④ Turn signal lamps

- ⑤ Brake lamps
- ⑥ Tail lamps
- ⑦ Rear fog lamp
- ⑧ License plate lamp
- ⑨ Backup lamps
- ▶ Switch off the lighting system.
- ▶ Undo screws ① and remove lamp lens ②.
- ▶ Applying light pressure to the bulb, turn it counter-clockwise and remove it from the bulb holder.
- ▶ Press the new bulb into the bulb holder and screw it in clockwise.
- ▶ Position lamp lens ② and tighten screws ①.

Additional lamps

Additional turn signal lamp on the roof

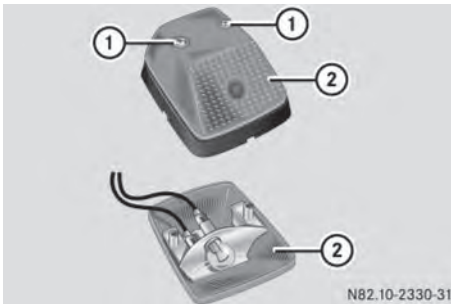

- Type of lamp: P 21 W
- ▶ Switch off the lighting system.
 - ▶ Undo screws ① and remove lamp lens ②.
 - ▶ Applying light pressure to the bulb, turn it counter-clockwise and remove it from the bulb holder.
 - ▶ Press the new bulb into the bulb holder and screw it in clockwise.
 - ▶ Position lamp lens ② and tighten screws ① again.

Perimeter lamp (Cab Chassis)

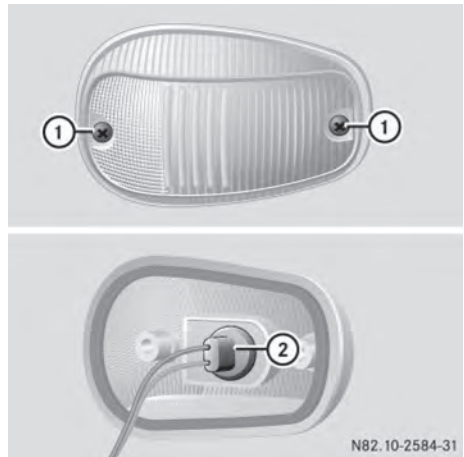

- Type of lamp: W 5 W
- ▶ Switch off the lighting system.
 - ▶ Undo screws ① and remove the lamp unit.
 - ▶ Turn bulb holder ② and remove it.
 - ▶ Remove the bulb from bulb holder ②.
 - ▶ Press the new bulb into bulb holder ②.
 - ▶ Screw bulb holder ② into the lamp unit.
 - ▶ Carefully position the lamp housing and tighten screws ①.

Courtesy lights

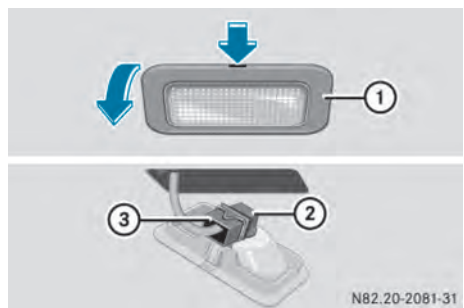

- Type of lamp: W 5 W
- ▶ Press in the latching spring of courtesy light ① with a suitable implement, e.g. a screwdriver.
 - ▶ Pry off courtesy light ①.

- ▶ Disconnect cable connector ③.
- ▶ Unscrew bulb holder ②.
- ▶ Remove the bulb from bulb holder ②.
- ▶ Press the new bulb into bulb holder ②.
- ▶ Screw bulb holder ② into courtesy light ①.
- ▶ Connect cable connector ③.
The connector locking spring must engage.
- ▶ Align courtesy light ① on the side and engage.

Interior lighting

General notes

- ❗ Have the bulbs in the overhead control panel replaced at a qualified specialist workshop. You could otherwise damage the overhead control panel.

Front interior light

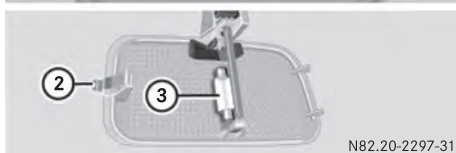
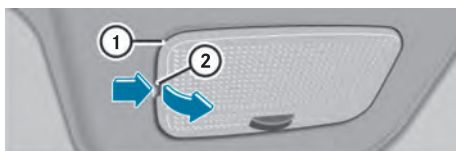

Type of lamp: K 18 W

- ▶ Switch off the interior lighting.
- ▶ Press spring catch ② in the direction of the arrow and lift off interior light ①.
- ▶ Remove bulb ③ from the bulb holder.
- ▶ Insert new bulb ③.
- ▶ Align interior light ① on the right-hand side and engage the spring catch.

Rear interior light

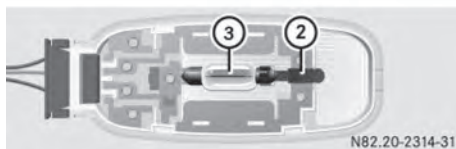

Interior light with switch

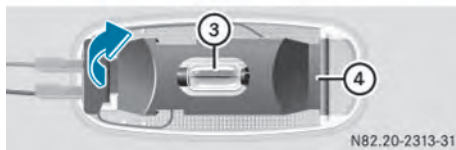

Interior light without switch

Type of lamp: K 15 W

- ▶ Switch off the interior lighting.
- ▶ Press in the catch spring of lamp housing ① with a suitable object, e.g. with a screwdriver, and pry off lamp housing ①.
- ▶ **Interior light without switch:** open protective cover ④.
- ▶ Press the contact spring of bulb holder ② outwards and remove bulb ③.
- ▶ Insert new bulb ③.
- ▶ **Interior light without switch:** fold back protective cover ④.
- ▶ Align lamp housing ① on the left-hand side and engage.
- ▶ **i Vehicles with LED lighting:** if an LED is faulty, consult a qualified specialist workshop.

Cargo compartment lamp



Type of lamp: W 10 W

- ▶ Switch off the interior lighting.
- ▶ Undo screws ① and remove the lamp lens.
- ▶ Press bulb ② into the bulb holder and unscrew it counter-clockwise.
- ▶ Press new bulb ② into the bulb holder and screw it in clockwise.
- ▶ Position the lamp lens and tighten screws ①.

i **Vehicles with LED cargo compartment lamp:** if an LED is defective, consult a qualified specialist workshop.

Windshield wipers

Switching the windshield wiper on/off

! Do not operate the windshield wipers when the windshield is dry, as this could damage the wiper blades. Moreover, dust that has collected on the windshield can scratch the glass if wiping takes place when the windshield is dry.

If it is necessary to switch on the windshield wipers in dry weather conditions, always use washer fluid when operating the windshield wipers.

! If the windshield wipers leave smears on the windshield after the vehicle has been washed in an automatic car wash, wax or other residues may be the reason for this. Clean the windshield using washer fluid after washing the vehicle in an automatic car wash.

! Vehicles with rain/light sensor: Switch the wipers off in dry weather. Otherwise, dirt or optical effects may cause undesired windshield wiper sweeps. This could then damage the windshield wiper blades or scratch the windshield.

The windshield will no longer be wiped properly if the wiper blades are worn. Replace the wiper blades twice a year (▷ page 108), ideally in spring and fall.

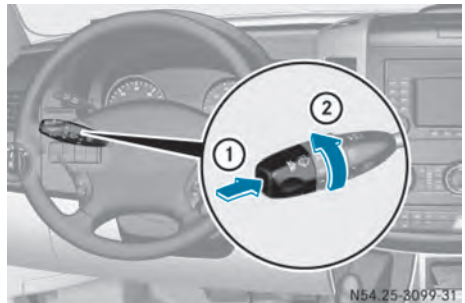

Combination switch

- ▶ Turn the SmartKey to position **1** or **2** in the ignition lock.
 - ▶ Turn the combination switch in the direction of arrow ② to the appropriate setting depending on the intensity of the rain.
 - ▶ **Single wipe:** push the combination switch briefly to the pressure point in the direction of arrow ①.
 - ▶ **To wipe with washer fluid:** press the combination switch beyond the pressure point in the direction of arrow ①.
- i** Wipe the windshield using washer fluid even if it is raining. By doing so, you will prevent smears on the windshield.

The detent positions of the combination switch correspond to the following wiper speeds:

- 0 Windshield wipers off
- I Intermittent wipe
- II Normal wipe
- III Rapid wipe

i Canada only:

If the windshield wipers are switched on and you stop the vehicle, the windshield wiper speed is reduced. For example, if you have selected level **II** and stop the vehicle, wiping continues with intermittent wipe while the vehicle is stationary. If intermittent wipe is selected, the intervals become longer.

Vehicles with a rain and light sensor: you can use level **I** as the universal setting. The rain and light sensor sets the appropriate wiping frequency automatically, according to the intensity of the rain. When you stop the vehicle, levels **III** and **II** are switched down to level **I** automatically.

The windshield wiper will return to the original level when you drive faster than 5 mph (8 km/h).



You can adjust the sensitivity of the rain and light sensor using the on-board computer (▷ page 196).

Information on checking the washer fluid level can be found in the "Maintenance and care" (▷ page 257) section.

Switching the rear window wiper on/off



Combination switch

- ①  Rear window wiper switch
- ②  To wipe with washer fluid
- ③ **I** To switch on intermittent wiping
- ④ **0** To switch off intermittent wiping
- ⑤  To wipe with washer fluid

▶ Turn the key to position **1** or **2** in the ignition lock.

▶ Turn switch ① to the corresponding position

The rear window wiper switches on automatically if you engage reverse gear and the windshield wipers are on.

Replacing the wiper blades

WARNING

If the windshield wipers begin to move while you are changing the wiper blades, you could be trapped by the wiper arm. There is a risk of injury.

Always switch off the windshield wipers and ignition before changing the wiper blades.

! Never open the hood if a windshield wiper arm has been folded away from the windshield.

Never fold a windshield wiper arm without a wiper blade back onto the windshield/rear window.

Hold the windshield wiper arm firmly when you change the wiper blade. If you release the windshield wiper arm without a wiper blade and it falls onto the windshield, the windshield may be damaged by the force of the impact.

We recommend that you have the wiper blades replaced at a qualified specialist workshop.

! Only hold the wiper blade by the wiper arm. You could otherwise damage the wiper rubber.

The windshield will no longer be wiped properly if the wiper blades are worn. Replace the wiper blades twice a year, ideally in spring and fall.

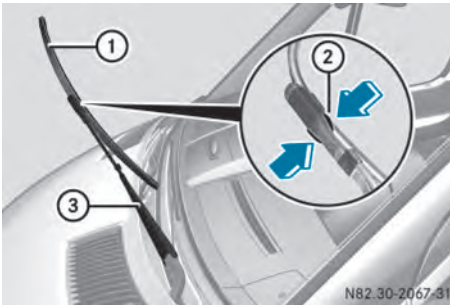

Front windshield wiper arm with wiper blade

- ▶ Fold wiper arm ③ away from the windshield.
- ▶ Set wiper blade ① at right angles to the wiper arm.
- ▶ Press both retaining clips ② together in the direction of the arrow and swing wiper blade ① away from wiper arm ③.
- ▶ Pull wiper blade ① up and out of the retainer on wiper arm ③.
- ▶ Slide new wiper blade ① into the retainer on wiper arm ③.
- ▶ Press new wiper blade ① onto wiper arm ③ until you hear retaining clips ② engage.
- ▶ Fold wiper arm ③ back onto the windshield again.

Problems with the windshield wipers

Problem	Possible causes/consequences and ► Solutions
The windshield wiper jams.	<p>Leaves or snow, for example, may be obstructing the windshield wiper movement. The wiper motor has switched off.</p> <ul style="list-style-type: none">► Stop the vehicle as soon as possible, paying attention to road and traffic conditions.► For safety reasons, you should remove the SmartKey from the ignition lock.► Remove the cause of the obstruction.► Switch on the windshield wiper again.
The windshield wiper does not move at all.	<p>There is a malfunction in the windshield wiper drive.</p> <ul style="list-style-type: none">► Select another wiper speed on the combination switch.► Have the windshield wiper checked at a qualified specialist workshop.

Useful information	112
Overview of climate control systems	112
Operating the climate control system	116
Adjusting the air vents	121
Operating the auxiliary heating system	122
Operating the cargo compartment air vents	133

Useful information

This Operator's Manual describes all models as well as standard and optional equipment of your vehicle that were available at the time of going to print. Country-specific variations are possible. Note that your vehicle may not be equipped with all of the described functions. This also applies to systems and functions relevant to safety.

Read the information on qualified specialist workshops (▷ page 26).

Overview of climate control systems

Important safety notes

Observe the recommended settings on the following pages. Otherwise, the windows could fog up.

Climate control regulates the temperature and the humidity in the vehicle interior and filters undesirable substances from the air.

Climate control is only operational when the engine is running. The system only functions optimally when the side windows are closed.

- i** Ventilate the vehicle for a brief period during warm weather. In order to cool the vehicle more rapidly, switch climate control to air-recirculation mode briefly. This will speed up the cooling process and the desired vehicle interior temperature will be reached more quickly.
- i** The integrated filter can filter out most particles of dust and completely filters out pollen. A clogged filter reduces the airflow into the vehicle interior. For this reason, you should always observe the interval for replacing the filter, which is specified in the Maintenance Booklet. As it depends on environmental conditions, e.g. heavy air pollution, the interval may be shorter than stated in the Maintenance Booklet.

Heating control panel

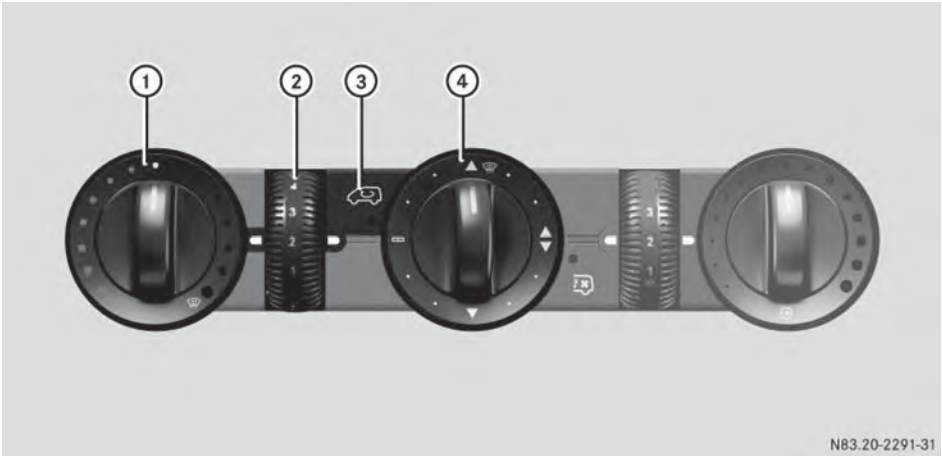

N83.20-2291-31

- ① Sets the temperature (▷ page 117)
 Defrosts the windshield (▷ page 118)
- ② Sets the airflow (▷ page 118)
 Defrosts the windshield (▷ page 118)
- ③ Switches air-recirculation mode on/off (▷ page 120)
- ④ Sets the air distribution (▷ page 117)
 Defrosts the windshield (▷ page 118)

Information on heating

Below, you can find a number of notes and recommendations to help you use the heating optimally.

- Set the temperature control to the middle level. Only change the temperature in small increments.
- Only use the defrosting function briefly, until the windshield is clear again.
- Only use air-recirculation mode briefly, e.g. if there are unpleasant outside odors or when in a tunnel. The windows could otherwise fog up as no fresh air is drawn into the vehicle in air-recirculation mode.

Control panel for the air-conditioning system

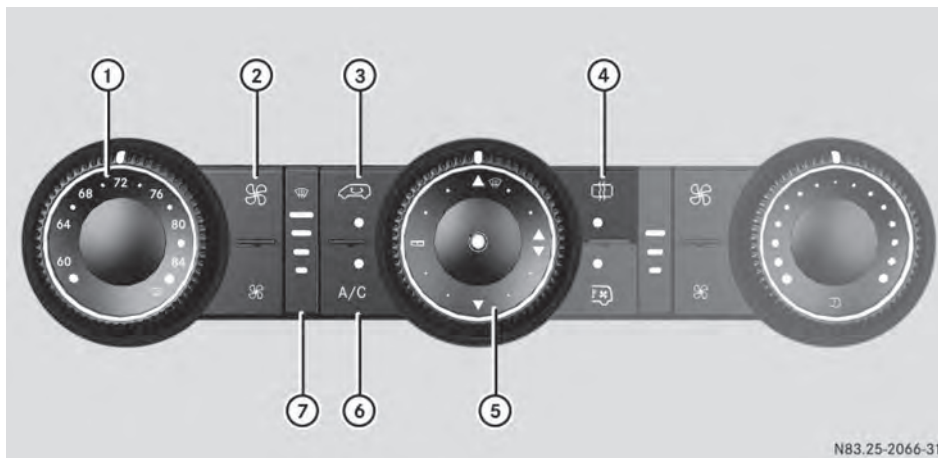

N83.25-2066-31



- ① Sets the temperature (▷ page 117)
 Defrosts the windshield (▷ page 118)
- ② Sets the airflow (▷ page 118)
 Increases the airflow
 Reduces the airflow
- ③ Switches air-recirculation mode on/off (▷ page 120)
- ④ Switches the reheat function (window air dehumidification) on/off (▷ page 118)
- ⑤ Sets the air distribution (▷ page 117)
 Defrosts the windshield (▷ page 118)
- ⑥ Switches cooling with air dehumidification on/off (▷ page 117)
- ⑦ Blower setting bar display
 Defrosts the windshield (▷ page 118)

Information on the air-conditioning system

Below, you can find a number of notes and recommendations to help you use the air-conditioning system optimally.

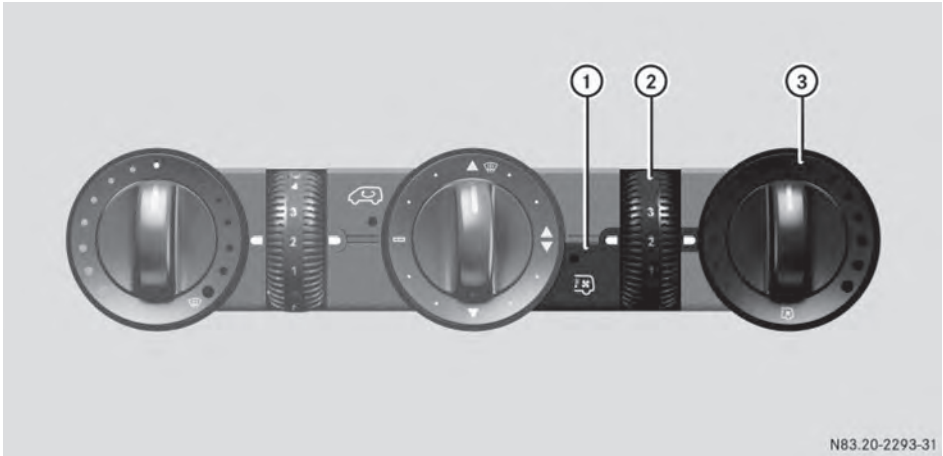
- Switch on the cooling with air dehumidification function. The indicator lamp in the switch lights up.
- Set the temperature to 72 °F (22 °C). Only change the temperature in small increments.
- Only use the "defrosting" function briefly, until the windshield is clear again.
- Only use air-recirculation mode briefly, e.g. if there are unpleasant outside odors or when in a tunnel. The windows could otherwise fog up as no fresh air is drawn into the vehicle in air-recirculation mode.
- Only use the reheat function until the fogged up windows are clear again.

Rear-compartment heating control panel

- ①  Switches the rear-compartment heating on/off (▷ page 116)
- ②  Sets the airflow (▷ page 118)
- ③  Sets the temperature (▷ page 117)

Information on rear-compartment heating

For optimum climate control, set the temperature control to the middle level. Only change the temperature in small increments.

Control panel for rear-compartment air-conditioning system

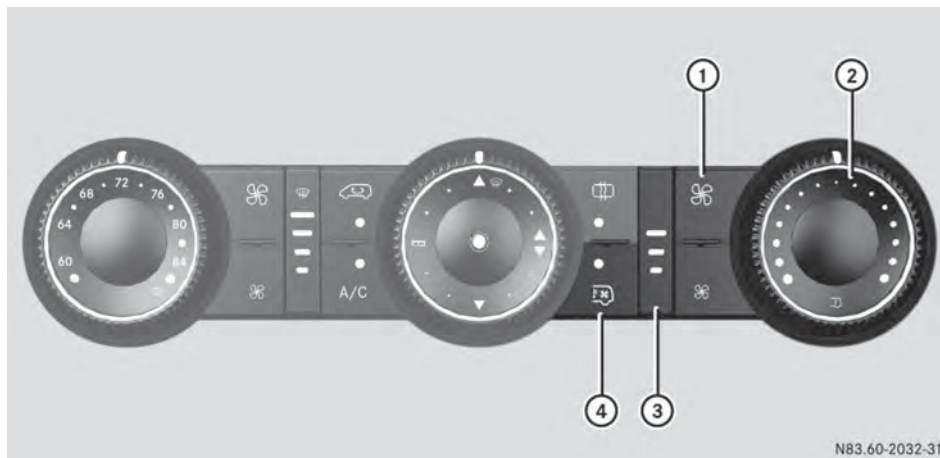

N83.60-2032-31

- ① Sets the airflow (▷ page 118)
 - Increases the airflow
 - Reduces the airflow
- ② Sets the temperature (▷ page 117)
- ③ Blower setting bar display
- ④ Switches the rear-compartment air conditioning on/off (▷ page 116)

Information on rear-compartment air conditioning

For optimum climate control, set the temperature control to the middle level. Only change the temperature in small increments.

Operating the climate control system

Switching the climate control on/off

Important information

When the climate control is switched off, air intake and air circulation also stop. Only use this setting for a brief period. Otherwise, the windows could fog up.

Activating/deactivating climate control via the control panel

- ▶ Turn the key to position 2 in the ignition lock.

Vehicle with heating

- ▶ **To switch on:** set airflow control ② down to at least level 1 (▷ page 114).
- ▶ **To switch off:** set airflow control ② up to the 0 position (▷ page 114).

Vehicle with air conditioning

- ▶ **To switch on:** press the button. The blower speeds are shown in bars next to the button.
- ▶ **To switch off:** press the button and, after reaching the lowest blower speed, press it again.

Activating/deactivating rear-compartment climate control via the control panel

- ▶ Turn the key to position **2** in the ignition lock.

Vehicle with rear-compartment heating/rear-compartment air conditioning

- ▶ **To switch on/off:** press the  switch. If the indicator lamp in the button lights up, the rear-compartment heating/rear-compartment air conditioning is switched on.

Switching the cooling with air dehumidification function on/off

Important information

If you switch off the "Cooling with air dehumidification" function, the air inside the vehicle will not be cooled (in warm weather) or dehumidified. The windows could fog up more quickly.

The cooling with air dehumidification function is only available when the engine is running. The air inside the vehicle is cooled and dehumidified according to the temperature selected.

Condensation may appear on the underside of the vehicle when in cooling mode. This is normal and not a sign that there is a malfunction.

Switching on/off

Vehicle with air conditioning

- ▶ Press the  button. If the indicator lamp in the button lights up, cooling with air dehumidification is switched on.

Setting the temperature



Increasing/reducing temperature in the front compartment via the control panel

Only change the temperature in small increments. Start at the center position, or at 22 °C.

- ▶ Switch on climate control (▶ page 116).
- ▶ Turn temperature control  clockwise to increase or counterclockwise to reduce the temperature (▶ page 114).

Increasing/reducing temperature in the rear compartment via the control panel

Only change the temperature in small increments.



- ▶ Switch on climate control (▶ page 116).
- ▶ Turn rear-compartment temperature control  (▶ page 115) or rear-compartment air-conditioning system  (▶ page 116) clockwise to increase or counterclockwise to reduce the temperature.



- i** Vehicles with additional air conditioning and heating in the rear compartment: if you set the temperature control to the center position, only one of the two climate control systems works in the rear compartment and in air-recirculation mode (▶ page 120).

Setting the air distribution

Air distribution settings

The air distribution symbols have the following meanings:



-  Directs air through the center and side air vents
-  Directs air to the windshield and the air vents
- 

-  Directs air to the windshield, the air vents and into the footwell
-  Directs air to the air vents and into the footwell

Adjusting

- ▶ Switch on climate control (▷ page 116).
- ▶ Set air-distribution control ④ for the heating (▷ page 113) or air-conditioning system ⑤ (▷ page 114) to the corresponding symbol.

Setting the airflow

- ▶ Switch on climate control (▷ page 116).
- ▶ **Vehicle with heating/rear-compartment heating:** set airflow control ② of the heating (▷ page 113) or of the rear-compartment heating (▷ page 115) to the desired level.
- ▶ **Vehicle with air conditioning/rear-compartment air conditioning:** press the  button to reduce or the  button to increase the airflow.
The blower speeds are shown in bars next to the buttons.



Defrosting the windows

You can use the "defrosting" function to defrost the windshield or to demist the inside of the windshield and the side windows.





Only use the following settings until the windows are clear again.

- ▶ **Vehicle with window heating:** switch on the front (▷ page 119) and/or rear window defroster (▷ page 120).
- ▶ Switch on climate control (▷ page 116).

Vehicle with heating

- ▶ Set temperature control ① and airflow control ② to  (▷ page 113).
- ▶ Set air-distribution control ④ to   (▷ page 113).
- ▶ Close the center air vents (▷ page 121) and the air outlets for the headroom and the rear compartment (▷ page 121).
- ▶ Direct the side air vents towards the side windows and open the defroster vents for the side windows (▷ page 121).

Vehicle with air conditioning

- ▶ Set temperature control ① to  (▷ page 114).
- ▶ Press the  button until the maximum blower output is reached.
All bars in the display next to the button light up.
- ▶ Set air-distribution control ⑤ to   (▷ page 114).
- ▶ Close the center air vents (▷ page 121) and the air outlets for the headroom and the rear compartment (▷ page 121).
- ▶ Direct the side air vents towards the side windows and open the defroster vents for the side windows (▷ page 121).



Clearing condensation from the windows

Windows fogged up on the inside



You should only select this setting until the windows are clear again.

- ▶ **Vehicle with window heating:** switch on the front (▷ page 119) and/or rear window defroster (▷ page 120).
- ▶ Switch on climate control (▷ page 116).
- ▶ Switch off air-recirculation mode (▷ page 120).

Vehicle with heating

- ▶ Set temperature control ① to a higher temperature (▷ page 113).
 - ▶ Set airflow control ② to a higher blower setting. It should be set at least to level two (▷ page 113).
 - ▶ Set air-distribution control ④ to   (▷ page 113).
- i** If the windows still fog up, set the control as described for defrosting (▷ page 118).

Vehicle with air conditioning

- ▶ Activate cooling with air dehumidification (▷ page 117).
- ▶ Press the  button (▷ page 114). The reheat function is switched on. The indicator lamp in the switch lights up. To switch off the reheat function, press the  button again. The indicator lamp in the button goes out.

Windows fogged up on the outside

You should only select this setting until the windshield is clear again.

- ▶ Switch on the windshield wipers (▷ page 107).
- ▶ Switch on climate control (▷ page 116).
- ▶ Adjust air distribution to the footwell (▷ page 117).
- ▶ Close the air vents (▷ page 121).



Windshield defroster

Windshield heater



Windshield heater switch

The windshield heater consumes a lot of power. You should therefore switch it off as soon as the windshield is clear. The windshield heating otherwise switches off automatically after 5 minutes.

- ▶ Start the engine.
- ▶ **To switch on/off:** press the  switch. The indicator lamp in the  button comes on when the windshield heating is switched on.

If the indicator lamp in the  windshield heating button flashes, the on-board voltage is too low. The windshield heating has switched off prematurely or cannot be activated.

- ▶ Switch off any consumers that are not required, e.g. reading lamps or interior lighting.

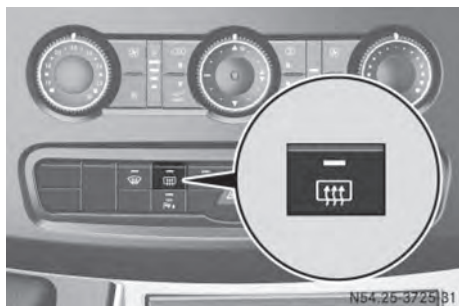

If enough on-board voltage is available again within 30 seconds, the windshield heating automatically switches on again. It otherwise remains switched off.

Rear window defroster



Rear window defroster switch

The rear window defroster consumes a lot of power. You should therefore switch it off as soon as the window is clear. The rear window defroster otherwise switches off automatically after 12 minutes.

- ▶ Start the engine.
- ▶ **To switch on/off:** press the  switch. The indicator lamp in the  button comes on when the rear window defroster is switched on.

If the indicator lamp in the  rear window defroster button flashes, the on-board voltage is too low. The rear window defroster has switched off prematurely or cannot be activated.

- ▶ Switch off any consumers that are not required, e.g. reading lamps or interior lighting.

If enough on-board voltage is available again within 30 seconds, the rear window defroster automatically switches on again. It otherwise remains switched off.

Switching air-recirculation mode on/off

Important safety notes



When you switch on air-recirculation mode, the windows could fog up more quickly, in particular at low outside temperatures. Only

switch on air-recirculation mode for a short time.

You can deactivate the intake of fresh air if unpleasant odors enter the vehicle from outside. The air inside the vehicle will only be circulated.

Heating/air-conditioning system

Air-recirculation mode switches off automatically after about 10 to 30 minutes, depending on the outside temperature.

- ▶ Switch on climate control (▷ page 116).
- ▶ **To switch on/off:** press the  switch. If the indicator lamp in the  button lights up, air-recirculation mode is activated.

Rear-compartment heating/rear-compartment air conditioning

On vehicles with a rear-compartment heating and air-conditioning system, you can activate/deactivate air-recirculation mode for the rear-compartment climate control.

- ▶ Switch on climate control (▷ page 116).
- ▶ **To activate:** set the temperature control of rear-compartment heating ③ (▷ page 115) or rear-compartment air conditioning system ② (▷ page 116) to the center position. Only one of the two climate control systems in the rear compartment is activated and is in air-recirculation mode.
- ▶ **To deactivate:** turn the temperature control of rear-compartment heating ③ (▷ page 115) or rear-compartment air conditioning system ② (▷ page 116) clockwise or counterclockwise. Only change the temperature in small increments.

Adjusting the air vents

Important safety notes

WARNING

Very hot or very cold air can flow from the air vents. This could result in burns or frostbite in the immediate vicinity of the air vents. There is a risk of injury.

Make sure that all vehicle occupants always maintain a sufficient distance to the air outlets. If necessary, redirect the airflow to another area of the vehicle interior.

The center and side air vents are adjustable. On vehicles with a rear-compartment air-conditioning system, you can also adjust the air vents in the roof duct.

- i** For virtually draft-free ventilation, adjust the sliders of the center air vents to the center position.

In order to ensure the direct flow of fresh air through the air vents into the vehicle interior, please observe the following notes:

- keep the air inlet grille on the hood free of blockages, such as ice, snow or leaves.
- never cover the vents or the ventilation grilles in the vehicle interior.

Setting the center air vents



- ① Center air vent, left
- ② Center air vent, right
- ③ Thumbwheel for center air vent, right
- ④ Thumbwheel for center air vent, left

- ▶ **To open:** turn thumbwheel ③ to the right or thumbwheel ④ to the left.
- ▶ **To close:** turn thumbwheel ③ to the left or thumbwheel ④ to the right.

Setting the side air vents

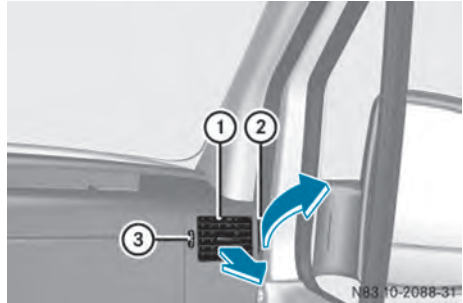

Side air vent (example: right-hand side of the vehicle)

- ▶ **To open:** turn thumbwheel ③ of side air vents ① upward.
- ▶ **To close:** turn thumbwheel ③ of side air vents ① downward.
- i** If the  symbol can be seen on thumbwheel ③, defroster vent ② is open.

Adjusting air vents for the passenger compartment



Air vents (example: right-hand side of the vehicle)

You can use the air vents to ventilate the vehicle interior on the left and right, in the rear and the headroom.

- ▶ **To open:** for the right-hand side of the vehicle, turn thumbwheel ② or for the left-hand side of the vehicle, thumbwheel ① of the air vents clockwise.
- ▶ **To close:** for the right-hand side of the vehicle, turn thumbwheel ② or for the left-hand side of the vehicle, thumbwheel ① of the air vents counter-clockwise.

Adjusting the air vents in the roof duct

❗ Always leave at least one air vent open.

If the rear-compartment air conditioning is switched on and all the air vents are closed, the air-conditioning system may be damaged.



On vehicles with rear-compartment air conditioning, adjustable air vents are integrated into the roof duct.

- ▶ **To adjust the airflow:** open or close the air flap in air vents ① as needed.
- ▶ **To adjust the air distribution:** turn air vent ① to the desired position.

Operating the auxiliary heating system

Important safety notes

⚠ DANGER

If the exhaust pipe is blocked or adequate ventilation is not possible, poisonous gases such as carbon monoxide (CO) may enter the

vehicle. This is the case, for example in enclosed spaces or if the vehicle gets stuck in snow. There is a risk of fatal injury.

Switch the auxiliary heating off in enclosed spaces without extraction systems, e.g. in garages. If the vehicle is stuck in snow and you have to leave the auxiliary heating running, keep the exhaust pipe and the area around the vehicle free of snow. To ensure an adequate supply of fresh air, open a window on the side of the vehicle that is not facing into the wind.

⚠ WARNING

When the auxiliary heating is switched on, parts of the vehicle can become very hot, e.g. the exhaust system. Flammable material such as leaves, grass or twigs may ignite if they come into contact with hot parts of the exhaust system. There is a risk of fire.

When the auxiliary heating is switched on, make sure that no flammable material can come into contact with hot vehicle components.

❗ Turn on the auxiliary heating at least once a month for approximately 10 minutes. The auxiliary heating could otherwise be damaged.

❗ Make sure that the flow of hot air is not blocked. The auxiliary heating will otherwise overheat and switch off.

Your vehicle may be equipped with either an auxiliary hot-water heater or an auxiliary warm-air heater. Adjustment and operation of the:

- hot-water auxiliary heater is done via the on-board computer and with the auxiliary heating button in the control panel (▷ page 124) or with the remote control (▷ page 125).
- auxiliary warm-air heater is done via the timer above the overhead control panel (▷ page 127).

The auxiliary heating works independently of the engine and supplements the climate

control system in the vehicle. The auxiliary heating heats the air in the vehicle interior to the temperature set.

If your vehicle is equipped with a hot-water auxiliary heater, the auxiliary heating also keeps the coolant warm. This way, the load on the engine is minimized and fuel is saved.

The heater booster function (▷ page 130) of the auxiliary heating supports the climate control system when the engine is running and the outside temperature is low.

You can use the auxiliary heating at an outside temperature of up to 39 °F (4 °C). At an outside temperature above 39 °F (4 °C) the auxiliary heating system and the heater booster function switch off automatically.

Heating time

The heating time operating the auxiliary heating when the vehicle is stationary without the engine running depends on the outside temperature.

Outside temperature	Heating time
Above 23 °F (-5 °C)	Approx. 20 minutes
23 °F (-5 °C) to 5 °F (-15 °C)	Approx. 40 minutes
Below 5 °F (-15 °C)	Approx. 50 minutes

You can then switch on the auxiliary heating again.

If you do not start the engine for a while, the total duration of heating is limited to a maximum of 120 minutes to protect the starter battery. Switching on the auxiliary heating is then automatically disabled. You can, for example, switch on the auxiliary heating without the engine running if the outside temperature is -5 °F (-20 °C) a maximum of two times. If you try it again, the indicator lamps in the  button (▷ page 124) flash alternately for approximately 2 minutes to signal

switch-on interlock. The auxiliary heating cannot be switched on without starting the engine.

When the charge status of the starter battery is sufficient again, the switch-on interlock will be deactivated. To charge the starter battery, let the engine run. The engine runtime required to reach the necessary charge status depends on the outside temperature.

Outside temperature	Engine runtime
Above 32 °F (0 °C)	Approx. 10 minutes
32 °F (0 °C) to 14 °F (-10 °C)	Approx. 15 minutes
Below 14 °F (-10 °C)	Approx. 20 minutes

Before switching on

- ▶ Check the fuel level and top up if necessary. The auxiliary heating is operated directly using the vehicle's fuel. The tank must be at least a quarter full to ensure that the auxiliary heating functions.
- ▶ Switch on climate control (▷ page 116).
- ▶ Set the temperature control to the desired temperature (▷ page 117).
- ▶ Set the air distribution as required (▷ page 117).
- ▶ Open the center (▷ page 121) and side air vents (▷ page 121) and set them to the middle position.

i The auxiliary heating automatically switches to heater booster mode after the engine is started.

Operating with the button (control panel)

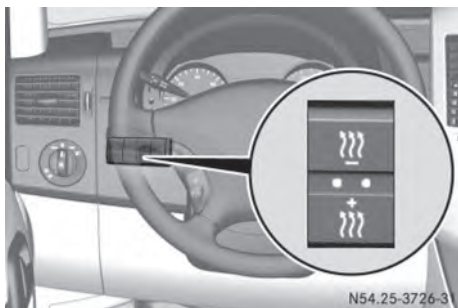

i Switch the heater booster function on or off with the  button (▷ page 130).

▶ **To activate the auxiliary heating system:** press the upper section of the  switch for longer than two seconds. The red indicator lamp in the button lights up. The auxiliary heating heats or ventilates the interior to the temperature that you have set. The blower switches to the first level.

▶ **To switch off auxiliary heating:** press the upper section of the  button.

Or

▶ Turn the key in the ignition lock to position **0**. The red indicator lamp in the button goes out. The auxiliary heating operates for another two minutes and then switches off automatically.

Selecting a switch-on time

Important information



You can use the on-board computer to define up to three switch-on times, one of which can be selected.

The yellow indicator lamp in the  button goes out after 30 minutes, if you:



- have selected the switch-on time and
- turn the key to position **0** in the ignition lock.



On-board computer without steering wheel buttons

▶ Turn the key to position **2** in the ignition lock.

▶ Press the  button. The  symbol flashes in the display.

Or

▶ Press the  menu button on the instrument cluster repeatedly until the  symbol flashes in the display.

▶ Use the  or  buttons on the instrument cluster to select the switch-on time **1** to **3**. The switch-on time selected is displayed.

▶ Wait 10 seconds for the standard display to appear.

The switch-on time is selected. The yellow indicator lamp in the  button lights up.

If you do not preselect a switch-on time, and **--:--** is shown in the display, this means that the automatic switch-on mode is switched off. The yellow indicator lamp in the  button goes out.

On-board computer with steering wheel buttons



▶ Turn the key to position **2** in the ignition lock.

▶ Press the  button. The **Aux. heat** submenu is shown in the display.

If no switch-on time has been selected, the selected switch-on time is highlighted or **Timer off** is highlighted.

i You can also access the **Aux. heat.** submenu via the **Settings** (▷ page 190) menu.

- ▶ Use the **+** or **-** button on the steering wheel to select the desired switch-on time.

Use the **Timer off** setting to deactivate automatic switch-on.

- ▶ Press the **☰** button on the steering wheel.
The switch-on time is selected. The yellow indicator lamp in the **☰** button lights up.

Setting the switch-on time

- ▶ Use the same method to select a switch-on time as described in the "Preselecting a switch-on time" section.

On-board computer without steering wheel buttons

- ▶ Press the **⓪** reset button on the instrument cluster.
The hour display flashes.
- ▶ Use the **+** and **-** buttons on the instrument cluster to set the hours.
- ▶ Press reset button **⓪**.
The minute display flashes.
- ▶ Use the **+** and **-** buttons to set the minutes.
The switch-on time is set and selected.

On-board computer with steering wheel buttons

- ▶ Press the **☰** button on the steering wheel.
The display shows the **Hours** menu.
- ▶ Use the **+** and **-** buttons on the steering wheel to set the hours.
- ▶ Press the **☰** button.
The display shows the **Minutes** menu.
- ▶ Use the **+** and **-** buttons to set the minutes.
- ▶ Press the **☰** button.
The switch-on time is set and selected.

Operation with the remote control

Important information

You can switch the auxiliary heating on/off and set the operating duration using the remote control. You can use up to 4 remote control units on the vehicle. These must be synchronized for the receiver in your vehicle (▷ page 126).

The remote control has a maximum range of approximately 600 meters. This range is reduced by:

- sources of interference
- solid objects between the remote control and the vehicle
- the remote control being in an unfavorable position in relation to the vehicle
- transmitting from an enclosed space

Overview of the remote control



- ① Indicator lamp
- ② To confirm settings
- ③ To switch the remote control on/off, set the operating duration or end or cancel settings

Indicator lamp ① lights up in various ways to show different operating modes:

Signaling	Meaning
Lights up red	Remote control switched on
	Data transfer



Signaling	Meaning
Flashes red	Auxiliary heating switched off
Lights up green	Auxiliary heating switched on
Flashes green	Change operating duration active
Flashes alternately red and green	Remote control in synchronizing mode

- i** When the remote control battery is weak, indicator lamp ① flashes red rapidly. Replace the remote control battery (▷ page 130).

You can find further information on the lamp status in the "Problems with the auxiliary heating" section (▷ page 132).

Switching the remote control on/off

The remote control switches to standby mode after 10 seconds. Indicator lamp ① goes out.

- ▶ **To switch on:** press and hold the  button until indicator lamp ① lights up red. If a connection between the remote control and the receiver in the vehicle has been established and indicator lamp ①:
 - flashes red, the auxiliary heating is switched off.
 - lights up green, the auxiliary heating is switched on.
- ▶ **To switch off:** press and hold the  button until indicator lamp ① goes out.

Switching the auxiliary heating on/off





- ▶ Switch on the remote control.
- ▶ **To switch on:** when indicator lamp ① flashes red, press the  button. During data transmission, indicator lamp ① lights up red.

When indicator lamp ① lights up green, the auxiliary heating is switched on.



- ▶ **To switch off:** when indicator lamp ① lights up green, press the  button. During data transmission, indicator lamp ① lights up red.

When indicator lamp ① flashes red, the auxiliary heating is switched off.

Changing the operating duration

- ▶ Switch on the remote control.
- ▶ When indicator lamp ① flashes red, press  and  simultaneously. Indicator lamp ① flashes green.
- ▶ Press the  button repeatedly until the desired operating duration is shown.
 - 20 minutes
Indicator lamp ① flashes green twice.
 - 30 minutes
Indicator lamp ① flashes green three times.
 - 40 minutes
Indicator lamp ① flashes green four times.
- ▶ Press the  button. During data transmission, indicator lamp ① lights up red. If indicator lamp ① emits two long, green flashes, the selected operating duration is stored.
- i** If no adjustment is made, indicator lamp ① flashes six times and the remote control goes into standby mode.

Synchronizing the remote control

- ▶ Press the  auxiliary heating button in the control panel (▷ page 124) for longer than 10 seconds. When you press and hold the  button, the red indicator lamp lights up in the button.

When the red indicator lamp in the  button flashes, the receiver in the vehicle is ready for synchronizing.

▶ Press and hold the  remote control button until indicator lamp ① lights up red. If there is an active connection between the remote control and the receiver, indicator lamp ① flashes alternately red and green. The remote control is in synchronizing mode.

❗ If you press the  button again on the remote control after starting synchronization, you will only synchronize this remote control unit with the receiver. Any other remote control units that were synchronized will be cleared. Indicator lamp ① flashes alternately red and green (very slowly).

▶ Press the  button on the remote control.

During data transmission, indicator lamp ① lights up red.

When remote control indicator lamp ① emits two long green flashes, the selected operating time is synchronized. The indicator lamp in the  auxiliary heating button goes out.

spaces, for example. There is a risk of fatal injuries.

- If highly flammable substances or flammable materials are nearby, there is a risk of a risk of fire and explosion.

Always deactivate the preselected switch-on times if you stop the vehicle in such or similar situations.

Use the timer to:



- activate/deactivate immediate heating mode
- set up to three switch-on times
- set the operating duration from 10 to 120 minutes or to continuous operation
- set the heating level (preselected temperature) to a range between 10 and 30

Timer overview







Timer above the overhead control panel

① Program column

-  Sets preselection memory 1 - 3 (▷ page 129)
-  Sets weekday (Mon. - Sun.) (▷ page 128)

② Menu bar

-  Activates/deactivates immediate heating mode (▷ page 128)
-  Sets the program times (▷ page 129)
-  Sets the day, time and the operating duration (▷ page 128)
-  Sets the heating level (▷ page 130)

Operation with the timer

Important safety notes

This is only for vehicles with a hot-water auxiliary heater.

DANGER

If a switch-on time has been selected, the auxiliary heating switches on automatically.

- If the ventilation is insufficient, poisonous exhaust gases can collect, in particular carbon monoxide. This is the case in enclosed

③ Display panel for: time, heating level and operating duration

Continuous operation mode active

Heating level set

④ Selects options in program column ① or menu bar ② (forwards)

Increases values

⑤ Confirms a selection or setting**⑥ Status bar**

Heating mode activated

⑦ Activates the timer

Cancels or ends settings in a menu

⑧ Selects options in program column ① or menu bar ② (backwards)

Reduces values

Activating the timer

The timer switches to standby mode after 10 seconds. The display goes off.

- ▶ Press and hold the button until the menu bar appears in the display and the time is shown.

Setting the day, time and operating duration

You must reset the day, time, and default value for the operating duration:

- during initial operation
- after a voltage supply interruption (e.g. if the battery has been disconnected)
- after a malfunction.

You can find further information on malfunctions in the "Problems with the auxiliary heating" section (▶ page 132).

- ▶ Press the or button until the symbol in menu bar ② flashes.
- ▶ Press the button.
In program column ①, the day selected flashes.
- ▶ Press the or button to set the desired day.

- ▶ Press the button.
The day selected is stored. The hour setting of the clock flashes.

- ▶ In the same way, set the hour and subsequently the minutes, then confirm by pressing the button.

The time is stored. Program column ① disappears and the operating duration flashes.

- i** The operating duration set is the default setting for immediate heating mode. You can set the operating duration from 10 to 120 minutes or activate continuous operation.

- ▶ Using the or button, set the minute value or select the symbol for continuous operation.

- ▶ Press the button.
The operating duration is stored. The time is shown.

Activating/deactivating immediate heating mode

- ▶ **To switch on:** press the or button until the symbol in the menu bar flashes.

- ▶ Press the button.
The operation duration flashes in the display.

- i** You can preset the default value that is shown (▶ page 128).

- ▶ Using the or button, set the minute value (10 – 120) or select the symbol for continuous operation.

- ▶ Press the button.
Immediate heating mode is activated. The time and the symbol appear.

- ▶ **To switch off:** press the or button until the symbol flashes in the menu bar, and then press the button.
Immediate heating mode is deactivated. The symbol disappears.

The auxiliary heating operates for another two minutes and then switches off automatically.

- i** If you switch off the ignition while immediate heating mode (operating duration 10– 120 minutes) is active, immediate heating mode is also switched off. The auxiliary heating operates for another two minutes and then switches off automatically.

If you have set continuous operation as the operating duration and you switch off the ignition, the auxiliary heating switches off automatically after about 15 minutes. If, in the remaining time, the ignition is switched on again, continuous operation of the auxiliary heating continues.

Setting the preselection time

WARNING

The auxiliary heating must not be operated if there are highly flammable substances nearby or in enclosed spaces without an extraction system. Make sure that the auxiliary heating is not switched on automatically by the timer in such places. If this possibility exists, deactivate the respective programmed time.





You can set three preselection times using the timer.





Observe that when setting the preselection time, this does not correspond to the switch-on time but to the switch-off or departure time. The auxiliary heating system starts up automatically and runs for the operating duration set prior to departure.

Example: For a planned departure time of 7:00 a.m., you should also set the preselection time to 7:00 a.m. If the operating duration is preset to 40 minutes, for example, the auxiliary heating starts up at 6:20 a.m.



If an identical time (time and day) is set in the preselection memory, only the last time set is saved.



After a malfunction or if the battery has been disconnected, you must set the preselection times again. You can find further information on malfunctions in the "Problems with the auxiliary heating" section (> page 132).

- ▶ Press the  or  button until the  symbol in the menu bar flashes.
- ▶ Press the  button.

In the program column, the  preselection memory numbers appear. The selected preselection memory flashes.
- ▶ Press the  or  button to select the desired preselection memory.
- ▶ Press the  button.

The preselection memory is selected. The days are shown.
- ▶ Set the day and time as described in the "Setting the day, time and operating duration" section (> page 128).

The preselection time is stored. The program column disappears. In the display panel, the **on** message and the  symbol appear.
- ▶ Press the  button.



The operating duration flashes.
- ▶ Press the  or  button to set the minute value (10 – 120).
- ▶ Press the  button.

The operating duration for the preselection time is saved. The time and number of the selected preselection memory are shown.
- i** The preselection memory that will be activated next is underlined. Additionally, the day that is set appears.

Deactivating the preselection time

- ▶ Carry out the steps as described in the "Setting the preselection time" section.







If the  symbol in the status bar is shown:

- ▶ Press the  or  button until the **off** message in the display panel is shown.
- ▶ Press the **OK** button.
The preselection time is deactivated. The time is shown.

Setting the heating level

You can set the heating level to a range between 10 and 30.

The heating level corresponds to a preselection temperature for the vehicle interior. This is a guide value and may, depending on the outside temperature, differ from the actual vehicle interior temperature.

- ▶ Press the  or  button until the  symbol in the menu bar flashes.
- ▶ Press the **OK** button.
The heating level display flashes.
- ▶ Using the  and  buttons, set the desired heating level to a range between 10 and 30.
- ▶ Press the **OK** button.
The heating level is set and the  symbol appears.

Switching the heater booster function on/off



Vehicles with auxiliary heating



Vehicles with heater booster function

At outside temperatures of up to 39 °F (4 °C) the fuel-fired heater booster system heats the vehicle interior as quickly as possible when the engine is running.

The auxiliary heating automatically switches to heater booster mode after the engine is started.

At an outside temperature above 39 °F (4 °C) the auxiliary heating system and the heater booster function switch off automatically.

If you switch off the engine without switching off the heater booster function, the system will be switched on the next time the engine is started (memory function).

i Switch the auxiliary heating on or off with the  button (> page 124).

- ▶ **To switch on/off:** press the  switch.
If the indicator lamp in the button lights up, the heater booster function is switched on.

After switching off, the auxiliary heating operates for about another 2 minutes and then switches off automatically.

Replacing the remote control battery

WARNING

Batteries contain toxic and corrosive substances. If batteries are swallowed, it can result in severe health problems. There is a risk of fatal injury.

Keep batteries out of the reach of children. If a battery is swallowed, seek medical attention immediately.



Environmental note



Batteries contain dangerous substances. It is against the law to dispose of them with the household rubbish. They must be collected separately and recycled to protect the environment.



Dispose of batteries in an environmentally friendly manner. Take discharged batteries to a qualified specialist workshop or a special collection point for used batteries.

If the indicator lamp on the remote control flashes red rapidly, the remote control battery is discharged. You should replace the remote control battery.

You need a battery of the type CR2430, which can be obtained at any qualified specialist workshop.



- ▶ Remove battery cover ② using a suitable implement, e.g. a coin, by turning it counter-clockwise.
- ▶ Check the seal on battery cover ② for damage and, if necessary, replace.
- ▶ Remove old batteries ③.
- ▶ Insert new, clean battery ③ into the battery tray with the positive pole facing upwards. Use a lint-free cloth to do so.

- ▶ Position battery cover ② so that mark ① on the raised area points between two recesses ④.
- ▶ Turn battery cover ② using a suitable implement, e.g. a coin, clockwise to the stop.
- ▶ Check all the functions of the remote control (> page 125).

Problems with the auxiliary heating

Problem	Possible causes/consequences and ► Solutions
The indicator lamp on the remote control flashes red rapidly.	<p>The remote control battery is discharged. Data transmission is not possible.</p> <p>► Replace the remote control battery (▷ page 130).</p>
The indicator lamp on the remote control flashes red and green in rapid succession.	<p>There is no connection between the remote control and the receiver in the vehicle.</p> <p>► Change your position in relation to the vehicle, e.g. hold the remote control higher or to the side.</p> <p>► Move closer.</p> <p>If you cannot establish a connection and the auxiliary heating is switched on, it can then only be deactivated using the  button (▷ page 124).</p>
The indicator lamp on the remote control flashes red and green in rapid succession.	<p>Several remote controls are being used at the same time.</p> <p>► Switch on the remote control again after a short while (▷ page 126).</p>
The indicator lamp on the remote control flashes red and green in rapid succession.	<p>The remote control is not synchronized.</p> <p>► Synchronize the remote control (▷ page 126).</p>
The indicator lamp on the remote control slowly flashes red and green alternately.	<p>The remote control is being synchronized.</p> <p>► Wait until the remote control synchronization process is complete (▷ page 126).</p>
The remote control for the auxiliary heating cannot be switched on.	<p>The remote control battery is discharged.</p> <p>► Replace the remote control battery (▷ page 130).</p>
The auxiliary heating does not switch on.	<p>The outside temperature is above 39 °F (4 °C). The auxiliary heating switches off automatically.</p>
The auxiliary heating switches off automatically and/or cannot be switched on.	<p>The fuel tank is less than 1/4 full. The auxiliary heating switches off automatically.</p> <p>► Refuel at the nearest gas station.</p> <p>► Then, start the auxiliary heating several times until the fuel lines are full.</p>

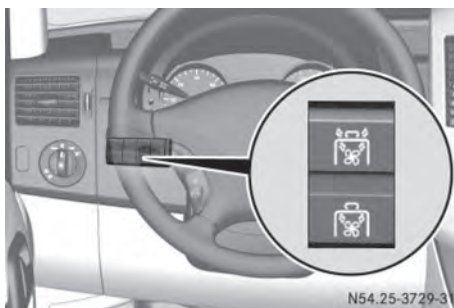

Problem	Possible causes/consequences and ► Solutions
The auxiliary heating switches off automatically and/or cannot be switched on.	The low-voltage protection system integrated in the control unit switches off the auxiliary heating because the on-board voltage is less than 10 V. ► Have the alternator and battery checked.
The auxiliary heating switches off automatically and/or cannot be switched on.	The fuse is blown. ► Replace the fuse; see the "Fuse allocation" supplement. ► Have the cause of the blown fuse determined at a qualified specialist workshop.
The auxiliary heating switches off automatically and/or cannot be switched on.	A malfunction has occurred. ► Switch the ignition on and off twice. If the auxiliary heating still cannot be switched on, the heating device is faulty. ► Have the auxiliary heating checked at a qualified specialist workshop.
The auxiliary heating is overheated.	The coolant level is too low. ► Check the coolant level and add more coolant if necessary (► page 255).

Operating the cargo compartment air vents



N54.25-3729-3

If your vehicle is equipped with a roof ventilator, you can ventilate and extract air from the cargo compartment.

- Turn the key to position **2** in the ignition lock.
- **To activate and extract air:** press the upper section of the  switch. The roof ventilator removes used air from the cargo compartment.
- **To activate and ventilate:** press the lower section of the  switch. The roof ventilator feeds fresh air into the cargo compartment.
- **To switch off:** set the switch to the middle position.

Useful information	136
Breaking-in notes	136
Driving	136
Automatic transmission	144
Refueling	148
Parking	151
Driving tips	153
Driving systems	161
Working mode	172
Towing a trailer	173

Useful information

This Operator's Manual describes all models as well as standard and optional equipment of your vehicle that were available at the time of going to print. Country-specific variations are possible. Note that your vehicle may not be equipped with all of the described functions. This also applies to systems and functions relevant to safety.

Read the information on qualified specialist workshops (▷ page 26).

Breaking-in notes

The first 1000 miles (1500 km)

New or replaced brake pads and brake disks only reach their optimum braking effect after a few hundred miles (a few hundred kilometers). Until then, compensate for this by applying greater force to the brake pedal.

For the service life and economy of your vehicle it is crucial that you break in the engine with due care.

- Therefore, protect the engine for the first 1000 miles (1500 km) by driving at varying vehicle and engine speeds.
- Avoid overstraining the vehicle and high engine speeds during this period, e.g. driving at full throttle. Do not exceed $\frac{3}{4}$ of the maximum speed for each gear.
- Do not change down a gear manually in order to brake.
- Try to avoid depressing the accelerator pedal beyond the point of resistance (kick-down).
- The shift ranges **3**, **2** or **1** should only be engaged when driving slowly, e.g. when driving in mountainous terrain.

After 1000 miles (1500 km), you can increase the engine speed gradually and accelerate the vehicle to full speed.

- i** You should also observe these notes on breaking-in if the engine or parts of the drive train on your vehicle have been replaced.

Driving

Important safety notes

WARNING

If you switch off the ignition while driving, safety-relevant functions are only available with limitations, or not at all. This could affect, for example, the power steering and the brake boosting effect. You will require considerably more effort to steer and brake. There is a risk of an accident.

Do not switch off the ignition while driving.

WARNING

If the parking brake has not been fully released when driving, the parking brake can:

- overheat and cause a fire
- lose its hold function.

There is a risk of fire and an accident. Release the parking brake fully before driving off.

Battery isolating switch

Important safety notes

- !** Make sure that the key is in position **0** in the ignition lock and wait at least 20 seconds before disconnecting or connecting the battery isolating switch. You could otherwise damage electrical system components.

You can use the battery isolating switch to disconnect the power supply to all your vehicle's consumers. This will prevent uncontrolled battery discharge caused by off-load current consumption.

If your vehicle is equipped with an auxiliary battery in the engine compartment, you will need to disconnect both batteries. Only then

is the electrical system fully disconnected from the power supply.

i Only switch the vehicle to de-energized using the battery main switch if:

- the vehicle is stationary for a lengthy period
- it is absolutely necessary

After the power supply has been activated, you will need to reset the side windows (▷ page 79).

Switching off the power supply

! When you clamp the connector under the accelerator pedal, make sure that the connector does not become damaged or dirty. It may otherwise not be possible to restore the electrical connection when the parts are reassembled.

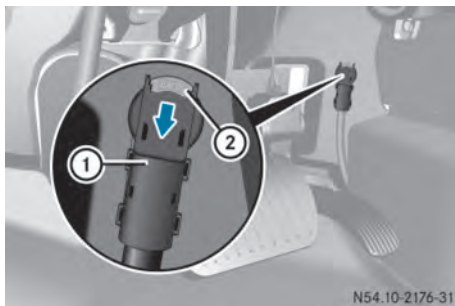

Battery isolating switch in the driver's footwell, on the right-hand side next to the accelerator pedal

- ▶ Remove the key from the ignition lock and wait for about 20 seconds.
- ▶ Press and hold button (2) and unplug connector (1) in the direction of the arrow from the earth pin.
- ▶ Clamp connector (1) under the accelerator pedal so that it cannot make contact with the earth pin.
All starter battery consumers are disconnected from the power supply.

Switching on the power supply

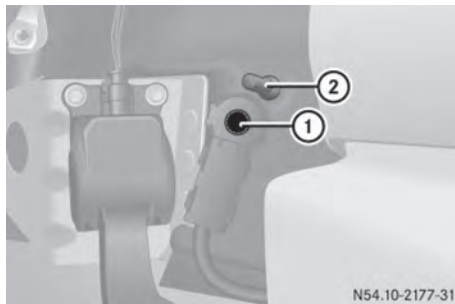

- ▶ Insert the key into the ignition lock.
- ▶ Press connector (1) onto earth pin (2) until you feel it engage and the lock inhibitor is released. Connector (1) must be in full contact with earth pin (2).

All consumers are reconnected to the DC power supply.

Key positions

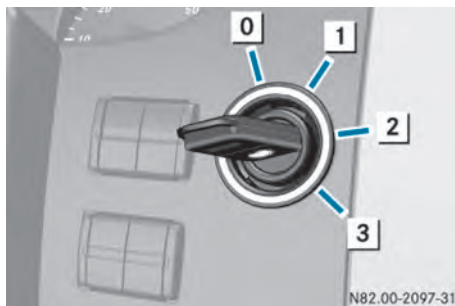

- 0 To insert/remove the key, to lock the steering wheel
- 1 To unlock the steering wheel, power supply for some consumers (e.g. the radio)
- 2 To switch on the ignition, power supply for all consumers, preglow and drive position
- 3 To start the engine

On vehicles with a battery main switch, you must first switch on the power supply (▷ page 136).

- i** To unlock the steering, move the steering wheel slightly while turning the key to position 1.

Preparing for a journey

Visual check of the vehicle exterior

- ▶ In particular, check the following components on the vehicle, and on the trailer as necessary:

- license plates, vehicle lighting, turn signals, brake lamps and wiper blades for dirt and damage
- tires and wheels for firm seating, correct tire pressure and general condition
- trailer tow hitch for play and security

- i** The trailer coupling is one of the most important vehicle parts with regard to road safety. The separate instructions issued by the manufacturer pertaining to operation, care and maintenance should be observed.

- ▶ Rectify any noticeable defects before commencing the journey.

Checks in the vehicle

Emergency equipment/first-aid kit

- ▶ Check the equipment to make sure that it is accessible, complete and ready for use.

The first aid and breakdown assistance equipment is in the front door stowage compartments and behind the driver's seat.

Vehicle lighting

- ▶ Turn the key to position 2 in the ignition lock.
- ▶ Check the lighting system with the aid of a second person.
- ▶ Replace defective bulbs (▷ page 100).

Before driving off

WARNING

Objects in the driver's footwell may restrict the clearance around the pedals or block a depressed pedal. This jeopardizes the operating and road safety of the vehicle. There is a risk of an accident.

Stow all objects securely in the vehicle so that they do not get into the driver's footwell. When using floor mats or carpets, make sure that they are properly secured so that they do not slip or obstruct the pedals. Do not place several floor mats or carpets on top of one another.

WARNING

Unsuitable footwear can hinder correct usage of the pedals, e.g.:

- shoes with thick soles
- shoes with high heels
- slippers

There is a risk of an accident.

Wear suitable footwear to ensure correct usage of the pedals.

- ▶ Secure the load as per the loading guidelines (▷ page 242).
- ▶ Make sure that the floor mats and carpets are properly secured so that they cannot slip and obstruct the pedals.
- ▶ Close all doors.

Starting the engine

WARNING



Combustion engines emit poisonous exhaust gases such as carbon monoxide. Inhaling these exhaust gases leads to poisoning. There is a risk of fatal injury. Therefore never leave the engine running in enclosed spaces without sufficient ventilation.

- !** Do not depress the accelerator pedal when starting the engine.

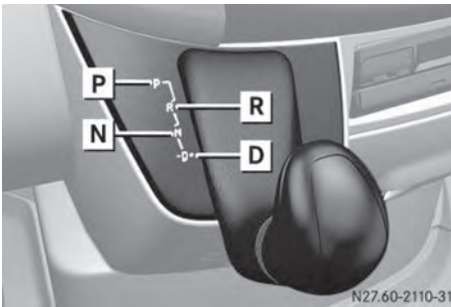
- ▶ Before starting the engine, make sure that:
 - all the doors are closed.
 - all the vehicle occupants are wearing their seat belts correctly.
 - the parking brake is applied.
- i** If you depress the brake pedal before starting the engine, the pedal travel is short and pedal resistance is high. If you depress the brake pedal again after starting the engine, pedal travel and resistance will be back to normal again.



Gearshift pattern

- P** Park position with parking lock
- R** Reverse gear
- N** Neutral
- D** Drive
- ▶ Move the selector lever to position **P**. The display in the instrument cluster shows **P**:
 - on vehicles with steering wheel buttons (▷ page 189)
 - on vehicles without steering wheel buttons (▷ page 184)
- i** You can also start the engine in neutral **N**.
- ▶ Turn the key to position **2** in the ignition lock. The  preglow indicator lamp in the instrument cluster lights up briefly.
- ▶ Once the  preglow indicator lamp goes out, turn the key to position **3** in the ignition lock and release it as soon as the engine is running.

- i** You can start the engine without preglow when the engine is warm.

The preglow system is malfunctioning if the  preglow indicator lamp lights up for approximately 1 minute:

- after the ignition is switched on
- while the engine is running

At extremely low outside temperatures you may then no longer be able to start the engine. Have the malfunction rectified at a qualified specialist workshop.

- i** Depending on the equipment installed, the vehicle either automatically locks centrally after switching on the ignition or after pulling away. The locking knobs in the doors drop down. You can open the doors from the inside at any time. Automatic door locking can be deactivated (▷ page 71).

Driving off

WARNING

If the engine speed is above the idling speed and you engage transmission position **D** or **R**, the vehicle could pull away suddenly. There is a risk of an accident.

When engaging transmission position **D** or **R**, always firmly depress the brake pedal and do not simultaneously accelerate.

- !** Only shift into reverse gear **R** when the vehicle is stationary. Otherwise, you could damage the transmission.
- ▶ Depress the brake pedal and keep it depressed. The selector lever lock is released.
- ▶ Move the selector lever to position **D** or **R**. On vehicles with a reverse warning feature, when reverse gear is engaged a warning tone sounds to alert other road users (▷ page 140).

- ▶ Release the parking brake (▷ page 152).
The  indicator lamp in the instrument cluster goes out.
 - ▶ Release the brake pedal.
 - ▶ Carefully depress the accelerator pedal.
- i** After pulling away or switching on the ignition, the vehicle automatically locks centrally. The locking knobs in the doors drop down.
- You can open the doors from the inside at any time.
- You can also deactivate the automatic locking feature (▷ page 71).

Reverse warning device

WARNING

Other road users may ignore or fail to hear the warning tone of the reverse warning feature. There is a risk of injury if you fail to ensure that the area in which you are maneuvering is clear.

Make sure that there are no persons or objects in the area in which you are maneuvering. It may be necessary to enlist the help of a second person when maneuvering.

The reverse warning feature is a system designed to assist you in ensuring the safety of other road users.

A warning signal sounds to alert other road users when reverse gear is engaged. The volume of the warning tone can be reduced for night-time driving.

- ▶ **To reduce the volume of the warning tone:** engage reverse gear twice in quick succession.

The warning tone is now quieter.

- i** The warning tone sounds at a normal volume by default. The volume of the warning tone has to be reduced each time you engage reverse gear if necessary.

ECO Start on Euro 6 engines

Important safety notes

WARNING

If ECO Start is activated, the engine can be started unintentionally, e.g. by accidentally depressing the clutch pedal. If work is being carried out on the engine under these circumstances, there is a risk of injury from moving engine parts.

Deactivate ECO Start before work is carried out on the engine.

WARNING

If the engine is switched off automatically and you exit the vehicle, the engine is restarted automatically. The vehicle may begin moving. There is a risk of accident and injury.

If you wish to exit the vehicle, always turn off the ignition and secure the vehicle against rolling away.

General notes

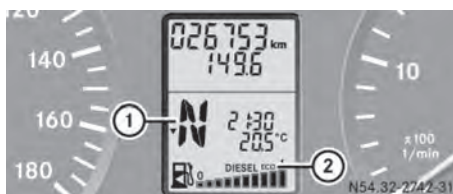

Messages in the display (example: vehicles without steering wheel buttons)

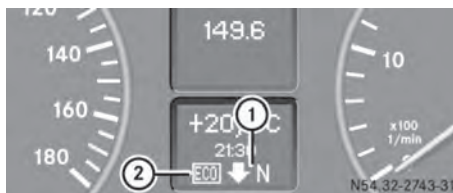

Messages in the display (example: vehicles with steering wheel buttons)

If  symbol ② is shown in the multifunction display, the ECO start/stop function switches the engine off automatically if the vehicle stops moving.

When pulling away again, the engine starts automatically. The ECO start/stop function thereby helps you to reduce the fuel consumption and emissions of your vehicle. The stop/start function is automatically activated each time you start the engine with the ignition key.

If the ECO start/stop function has been manually deactivated or a malfunction has caused the system to be deactivated, **ECO** symbol ② is not displayed. In addition, the indicator lamp in the ECO button on the center console does not light up.

Automatic engine switch-off

The ECO start/stop function is operational and the **ECO** symbol is displayed in the multifunction display, if:

- the indicator lamp in the ECO button is lit green
- the outside temperature is above 0 °C
- the vehicle is below 2500 m above sea level
- the hood is closed
- the driver's seat belt is fastened
- on vehicles with a manual transmission, the doors are closed
- on vehicles with an automatic transmission, the driver's door is closed

- ① All of the driving systems remain active when the engine is switched off automatically.
- ① The engine can be switched off automatically a maximum of four times (initial stop, then three subsequent stops) in succession. The automatic engine switch-off is then available again after the ECO symbol appears in the multifunction display.

Vehicles with automatic transmission

If the vehicle is braked to a standstill in **D** or **N**, the ECO start/stop function switches off the engine automatically.

Automatic engine start

The engine is started automatically if:

- you switch off the ECO start/stop function by pressing the ECO button
- you engage reverse gear **R** or park position **P**
- the vehicle begins to roll away
- the battery's condition of charge is too low
- on vehicles with a manual transmission, the driver's seat belt is not fastened or a door is opened
- on vehicles with an automatic transmission, the driver's seat belt is not fastened or the driver's door is opened

If you open the hood after an automatic engine switch-off, automatic engine start is deactivated. Once the hood is closed, you have to start the engine manually.

Vehicles with automatic transmission

The engine is started automatically if you:

- release the brakes when in transmission position **D** or **N**
- depress the accelerator pedal
- open the driver's door
- unfasten your seatbelt

- ① If you shift the transmission from **R** to **D**, the ECO start/stop function is available again as soon as the **ECO** symbol reappears in the multifunction display.

Activating/deactivating ECO Start





- ▶ **To switch off:** press the **ECO** button.
The indicator lamp on the **ECO** button and the ECO symbol in the multifunction display go out.
- ▶ **To switch on:** press the **ECO** button.
If all conditions for automatic engine switch-off are fulfilled, the ECO symbol is shown in the multifunction display. The indicator lamp in the **ECO** button lights up.
If not all conditions for automatic engine switch-off are fulfilled, the ECO symbol is not shown in the multifunction display. If this is the case, the ECO start/stop function is not available.

ECO Start is automatically reactivated once the engine has been restarted.

If the indicator lamp in the **ECO** button does not light up after the engine is started, ECO Start is malfunctioning and cannot be activated.

If you press the **ECO** button after an automatic engine switch-off, ECO Start is deactivated. However, you can start the engine once more by depressing the clutch pedal.

Problems with the engine	
Problem	Possible causes/consequences and ► Solutions
<p>The engine does not start. The starter motor can be heard.</p>	<p>There is air in the fuel system.</p> <ul style="list-style-type: none"> ► Turn the key back to position 0 in the ignition lock before attempting to start the engine again. ► Start the engine again. Please bear in mind that lengthy and frequent starting attempts will drain the battery. <p>If the engine does not start after several attempts:</p> <ul style="list-style-type: none"> ► Consult a qualified specialist workshop.
<p>The engine does not start. The starter motor can be heard. The reserve fuel warning lamp is lit and the fuel gage is at 0.</p>	<p>The fuel tank has been run dry.</p> <ul style="list-style-type: none"> ► Refuel the vehicle. <p>If you drive until the fuel tank is completely empty, air may get into the fuel system. If the engine does not start after refueling, bleed the fuel system as follows:</p> <ul style="list-style-type: none"> ► Turn the key to position 2 in the ignition for approximately 10 seconds. ► Start the engine continuously for a maximum of 60 seconds. <p>If the engine does not start:</p> <ul style="list-style-type: none"> ► Wait approximately 2 minutes. ► Restart the engine continuously for a maximum of 60 seconds. ► If the engine still fails start, do not continue trying to start it. ► Consult a qualified specialist workshop.
<p>The vehicle cannot be driven at a speed exceeding 5 mph (8 km/h). The yellow  engine diagnostic lamp and the yellow  DEF indicator lamp² light up.</p>	<p>The exhaust gas aftertreatment is faulty, an emission-relevant malfunction has occurred or the DEF reserve has been used up. This malfunction or defect can damage the exhaust gas aftertreatment.</p> <ul style="list-style-type: none"> ► Observe the messages in the display: <ul style="list-style-type: none"> • on vehicles without steering-wheel buttons (► page 202) • on vehicles with steering-wheel buttons (► page 213) and (► page 213).
<p>The engine does not start. The starter motor cannot be heard.</p>	<p>The battery isolating switch is switched off.</p> <ul style="list-style-type: none"> ► Switch on the power supply (► page 136).

² Only vehicles without steering-wheel buttons.

Problem	Possible causes/consequences and ► Solutions
The engine does not start. The starter motor cannot be heard.	The on-board voltage is too low. The battery is too weak or discharged. ► Jump-start the vehicle (► page 278). If the engine cannot be jump-started, the starter motor is faulty. ► Consult a qualified specialist workshop.
The engine does not start. The starter motor cannot be heard.	The battery is discharged or faulty. ► Check the battery for damage. ► Charge the battery (► page 266).

Automatic transmission

Important safety notes

WARNING

If the engine speed is above the idling speed and you engage transmission position **D** or **R**, the vehicle could pull away suddenly. There is a risk of an accident.

When engaging transmission position **D** or **R**, always firmly depress the brake pedal and do not simultaneously accelerate.

- !** Vehicles with automatic transmission may roll only briefly in the neutral position **N**. Prolonged rolling of the wheels, e.g. when being towed, will result in transmission damage.

Selector lever

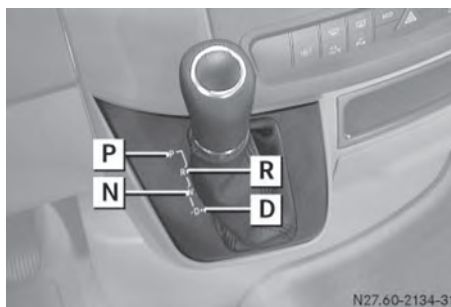

- P** Park position with parking lock
- R** Reverse gear
- N** Neutral
- D** Drive

The display in the instrument cluster shows the present selector lever position or the current shift range:

- on vehicles with steering wheel buttons (► page 189)
- on vehicles without steering wheel buttons (► page 184)

Selector lever positions

P

Park position

This prevents the vehicle from rolling away when stopped. Only move the selector lever to **P** if the vehicle is stationary.

You can only remove the key when the selector lever is in this position. The selector lever is locked in position **P** if the key is removed.

The parking lock should not be used as a brake when parking. Always apply the parking brake as well once you have parked the vehicle.

R

Reverse gear

Only move the selector lever to **R** when the vehicle is stationary.

N

Neutral

No power is transmitted from the engine to the drive wheels. Releasing the brakes will allow you to move the vehicle freely, e.g. by pushing or towing.

Do not move the selector lever to **N** while driving. The automatic transmission could otherwise be damaged.

If ASR is deactivated or ESP[®] has malfunctioned: only move the selector lever to **N** if the vehicle is in danger of skidding, e.g. on icy roads.

D

Drive

The automatic transmission changes gear itself. All forward gears are available.

You can influence the gearshifts and shift gears yourself or limit the shift range.

Changing gear

The 5-speed automatic transmission adapts to your individual driving style by continuously adjusting its shift points. These shift point adjustments take into account the current operating and driving conditions. If the operating or driving conditions change, the automatic transmission reacts by adjusting the gearshift program.

When the selector lever is in position **D**, the automatic transmission selects the individual gears automatically. This depends on:

- any restriction in the shift range (▷ page 146)
- the position of the accelerator pedal
- the road speed

Touchshift

When the selector lever is in position **D**, you can perform gearshifts yourself.

► **To shift down:** press the selector lever to the left towards **D-**.

The automatic transmission shifts to the next gear down, depending on the gear currently engaged. The shift range is also restricted.

i The automatic transmission does not shift down if you press the selector lever towards **D-** while traveling at too high a speed. This protects the engine from over-revving.

► **To shift up:** briefly press the selector lever to the right towards **D+**.

The automatic transmission shifts to the next gear up, depending on the current gearshift program. This also extends the shift range.

► **To derestrict the shift range:** press and hold the selector lever towards **D+** until **D** appears in the display again.

The automatic transmission shifts from the current shift range directly to **D**.

► **To select the optimum shift range:** press and hold the selector lever to the left towards **D-**.

The automatic transmission will shift to a range which allows easy acceleration and deceleration. To do this, the automatic transmission will shift down one or more gears.

Shift ranges

When the selector lever is in position **D** you can restrict or derestrict the shift range for the automatic transmission.

► **To extend/restrict the shift range:** press the selector lever briefly to the right towards **D+** or left towards **D-**.

The display shows the selected shift range. The automatic transmission shifts only as far as the relevant gear.

i If the maximum engine speed for the restricted shift range is reached and you depress the accelerator pedal, the automatic transmission will not shift up.

Driving situations

2 Use the braking effect of the engine on steep downhill gradients and for driving:

- on steep mountain roads
- in mountainous terrain
- in arduous conditions

1 Use the braking effect of the engine on extremely steep downhill gradients and long downhill stretches.

Driving tips

Accelerator pedal position

Your style of driving influences how the automatic transmission shifts gear:

- little throttle: early upshifts
- lots of throttle: later upshifts

Kickdown

Use kickdown for maximum acceleration:

- Depress the accelerator pedal beyond the pressure point.
The automatic transmission shifts to the next gear down, depending on the engine speed.
- Ease off on the accelerator pedal once the desired speed is reached.
The automatic transmission shifts up again.

Maneuvering

Maneuvering in a tight space:

- Control the vehicle's speed by braking carefully.
- Depress the accelerator pedal slightly and evenly.

i You can shift back and forth between drive position **D** and reverse gear **R** at low speeds without applying the brakes. This can help you, for example when rapidly maneuvering the vehicle or rocking it out of snow or slush.

Towing a trailer

- Drive at moderate engine speeds on steep uphill gradients.
- Depending on the uphill or downhill gradient, shift down to a shift range adapted to the driving situation (► page 146), even if cruise control is activated.

Problems with the transmission

Problem	Possible causes/consequences and ► Solutions
The transmission malfunctions when shifting gear.	The transmission is losing oil. ► Have the transmission checked immediately at a qualified specialist workshop.
The acceleration characteristics have deteriorated noticeably. The transmission does not shift.	The transmission is in emergency mode. It is only possible to shift into second gear or reverse gear R . ► Stop the vehicle. ► Depress the brake pedal. ► Move the selector lever to position P . ► Switch off the engine. ► Wait at least 10 seconds before restarting the engine. ► Depress the brake pedal. ► Move the selector lever to position D or R . In position D , the transmission shifts into second gear; in position R , the transmission shifts into reverse gear. ► Have the transmission checked immediately at a qualified specialist workshop.

Releasing the parking lock manually

In the event of a malfunction, it is possible to manually release the selector lever from the lock in parking position **P**, e.g. to have the vehicle towed away.



- Apply the parking brake.
- Remove cover ①.

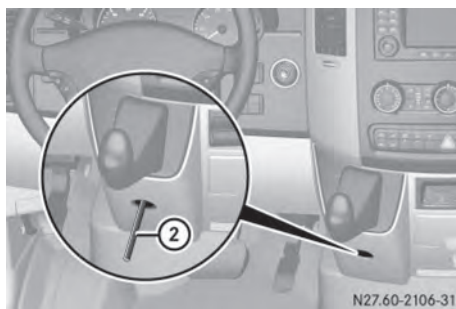

- Slide implement ② as far as it will go into the opening.
- Push the implement in and simultaneously move the selector lever out of position **P**. The selector lever lock is released. You can now move the selector lever freely again until it is returned to position **P**.
- Remove implement ②.
- Re-install cover ①.

- i** The screwdriver from the vehicle tool kit could function as the implement, for instance (▷ page 276).

Refueling

Important safety notes

⚠ WARNING

Fuel is highly flammable. Improper handling of fuel creates a risk of fire and explosion.

Avoid fire, open flames, smoking and creating sparks under all circumstances. Switch off the engine and, if applicable, the auxiliary heating before refueling.

⚠ WARNING

Fuel is poisonous and hazardous to health. There is a risk of injury.

You must make sure that fuel does not come into contact with your skin, eyes or clothing and that it is not swallowed. Do not inhale fuel vapors. Keep fuel away from children.

If you or others come into contact with fuel, observe the following:

- Wash away fuel from skin immediately using soap and water.
- If fuel comes into contact with your eyes, immediately rinse them thoroughly with clean water. Seek medical assistance without delay.
- If fuel is swallowed, seek medical assistance without delay. Do not induce vomiting.
- Immediately change out of clothing which has come into contact with fuel.

⚠ WARNING

If you mix diesel fuel with gasoline, the flash point is lower than that of pure diesel fuel. When the engine is running, exhaust system components could overheat without being noticed. There is a risk of fire.

Never refuel with gasoline. Never mix gasoline with diesel fuel.

🌿 Environmental note

If fuels are handled improperly, they pose a danger to persons and the environment. Do not allow fuels to run into the sewage system, the surface waters, the ground water or into the ground.

- ⚠** Do not use gasoline to refuel vehicles with a diesel engine. Even small amounts of gasoline will cause damage to the fuel system and engine.
 - ⚠** Do not switch on the ignition if you accidentally refuel with the wrong fuel. Otherwise, the fuel will enter the fuel lines. Notify a qualified specialist workshop and have the fuel tank and fuel lines drained completely.
 - ⚠** Overfilling the fuel tank could damage the fuel system.
 - ⚠** Take care not to spill any fuel on painted surfaces. You could otherwise damage the paintwork.
 - ⚠** Filter the fuel before transferring it to the vehicle if you are refueling the vehicle from barrels or containers.
This will prevent malfunctions in the fuel system due to contaminated fuel.
- Further information on fuel and on fuel grades can be found in the "Technical data" section (▷ page 321).

Refueling procedure

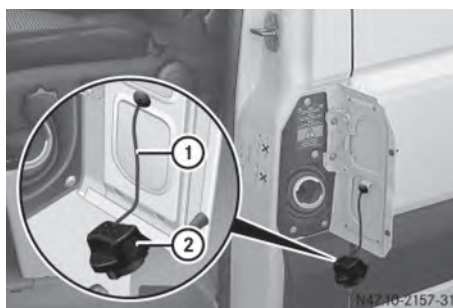

N4710-2157-31

The fuel filler flap is beside the front left-hand door when viewed in the direction of travel. It is only possible to open the fuel filler flap when the front door is open.

- ▶ Remove the key from the ignition lock.
- ▶ Switch off the auxiliary heating system (▷ page 122).
- ▶ Open the front left-hand door first, and then the fuel filler flap.
- ▶ Close all vehicle doors to prevent fuel vapors from entering the vehicle.
- ▶ Turn fuel filler cap ② counter-clockwise, remove it and let it hang from strap ①.
- ▶ Completely insert the filler neck of the fuel pump nozzle into the tank and refuel.
- ▶ Only fill the tank until the pump nozzle switches off. Fuel may otherwise leak out.
- ▶ Replace tank filler cap ② and turn clockwise.
You will hear a click when the fuel filler cap is closed fully.
- ▶ Open the front left-hand door first, and then close the filler flap.

Problems with the fuel and fuel tank

If your vehicle is losing fuel, the fuel lines or the fuel tank are defective.

- ▶ Turn the key to position **0** in the ignition lock immediately and remove it.
- ▶ Do not restart the engine under any circumstances.
- ▶ Consult a qualified specialist workshop.

Diesel Exhaust Fluid (DEF)

Important safety notes

♻ Environmental note

Dispose of DEF in an environmentally responsible manner.

- ❗ Only use DEF in accordance with ISO 22241. Never mix DEF with additives

or thin it with tap water. The exhaust gas aftertreatment may otherwise be damaged.

Observe the MB Specifications for Service Products, Sheet 352.0.

Damage that results from the use of additives or tap water leads to the loss of the New Vehicle Limited Warranty.

- ❗ If DEF comes into contact with a painted or aluminum surface, wash the surface off immediately with plenty of water.

- ❗ DEF is not a diesel additive and must not be mixed with fuel in the tank. Even small amounts of DEF can cause engine damage. Damage that results from the blending of DEF will not be covered by the New Vehicle Limited Warranty.

The exhaust gas aftertreatment requires a reducing agent, Diesel Exhaust Fluid (DEF), in order to function correctly.

When opening the DEF tank filler cap at high outside temperatures, ammonia vapors may escape.

Ammonia vapors have a pungent smell and primarily cause irritation of the:

- skin
- mucous membranes
- eyes

You may experience a burning sensation in your eyes, nose and throat, as well as coughing and watering of the eyes.

Do not inhale ammonia vapors. Avoid contact with DEF.

Do not allow DEF to come into direct contact with your skin; it is hazardous to your health. Rinse any affected areas off with plenty of clean water. Consult a doctor if necessary.

- i If the DEF level has dropped below the reserve range, add at least 2.0 US gal (7.6 l) of DEF at the latest after receiving the second warning message (▷ page 184).

- i** If you switch off the engine at a low outside temperature and add DEF, restart the engine after refueling. If you leave the vehicle parked without restarting the engine and the DEF freezes in the DEF tank, the on-board computer will only be able to register the new fill level after a defrosting period of up to 60 minutes. During this time the engine may only be operated in neutral.

You will find further information on DEF in the "Service products" section (▷ page 321).

Refueling procedure

DEF filler neck in the engine compartment

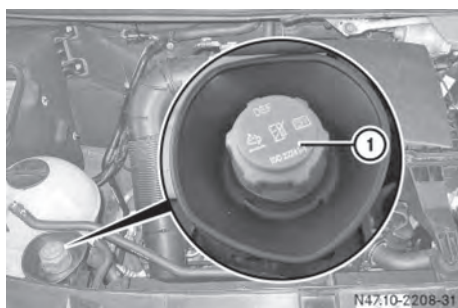

- ▶ Remove the key from the ignition lock.
- ▶ Switch off the auxiliary heating system (▷ page 130).
- ▶ Open the hood.
- ▶ Close all vehicle doors so that no ammonia vapors can enter the vehicle.
- i** Do not inhale any ammonia vapor which may escape when you unscrew cap ①. Ammonia vapors have a pungent odor. However, they are neither toxic nor hazardous to health in this concentration.
- ▶ Turn blue cap ① counter-clockwise and remove it.
- ▶ Only fill up the DEF tank until the DEF level is visible in the filler neck.
- ▶ Replace blue DEF filler neck cap ① on the filler neck and turn clockwise. You will hear a click when cap ① is fully closed.

DEF filler neck on the right-hand vehicle side

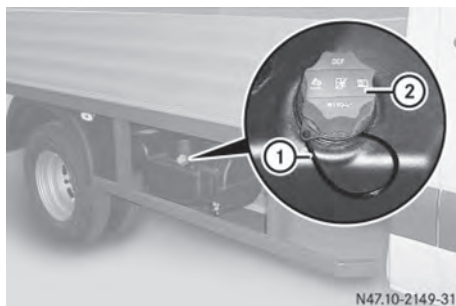

The DEF reservoir on the right-hand side of the vehicle (example: Cab Chassis)

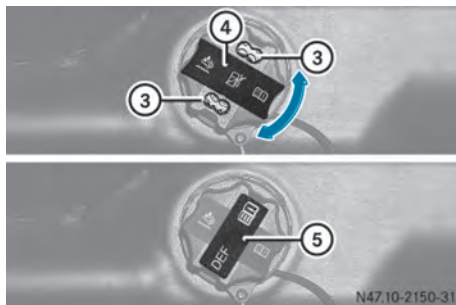

Fuel filler cap

- ▶ Remove the key from the ignition lock.
- ▶ Switch off the auxiliary heating system (▷ page 130).
- ▶ Remove tool ⑤ for unlocking tank filler cap ② from the footwell on the co-driver's side (▷ page 276).
- ▶ Close all vehicle doors so that no ammonia vapors can enter the vehicle.
- ▶ Pull cover ④ up, turn 90° and release.
- ▶ Insert tool ⑤ into hole ③ of tank filler cap ②.
- i** Do not inhale any ammonia vapor that may escape when you unscrew tank filler cap ②. Ammonia vapors have a pungent odor. However, they are neither toxic nor hazardous to health in this concentration.
- ▶ Turn blue filler cap ② counter-clockwise, remove it and let it hang from strap ①.

Make sure that tool ⑤ remains in tank filler cap ② while doing so.

- ▶ Only fill up the DEF tank until the DEF level is visible for the first time in the filler neck.
- ▶ Replace blue tank filler cap ② and turn clockwise.
- ▶ Pull tool ⑤ out of tank filler cap ② and stow with the vehicle tool kit in the footwell on the co-driver's side.
- ▶ Pull cover ④ up over hole ③ of tank filler cap ②, turn and release.
- ▶ Turn blue tank filler cap ②.
If tank filler cap ② turns freely, the DEF tank is closed.

Parking

Important safety notes

WARNING

Flammable material such as leaves, grass or twigs may ignite if they come into contact with hot parts of the exhaust system or exhaust gas flow. There is a risk of fire.

Park the vehicle so that no flammable materials come into contact with parts of the vehicle which are hot. Take particular care not to park on dry grassland or harvested grain fields.

WARNING

If you switch off the ignition while driving, safety-relevant functions are only available with limitations, or not at all. This could affect, for example, the power steering and the brake boosting effect. You will require considerably more effort to steer and brake. There is a risk of an accident.

Do not switch off the ignition while driving.

WARNING

If you leave children unsupervised in the vehicle, they could set it in motion by, for example:

- release the parking brake.
- shift the automatic transmission out of the parking position **P**.
- start the engine.

In addition, they may operate vehicle equipment and become trapped. There is a risk of an accident and injury.

When leaving the vehicle, always take the SmartKey with you and lock the vehicle. Never leave children unsupervised in the vehicle.

 A moving vehicle can lead to damage to the vehicle or damage to the drive train.

 When the vehicle is parked, always remove the key to prevent the battery from becoming discharged.

On vehicles with a battery isolating switch, switch off the power supply if the vehicle is to be out of use for a longer period of time.

Always park your vehicle safely and according to legal requirements and secure it against rolling away.

To ensure that the vehicle is properly secured against rolling away unintentionally:

- the parking brake must be firmly applied
- the selector lever must be in position **P** and the key must be removed from the ignition lock
- on steep uphill or downhill gradients, the front wheels must be turned towards the curb
- on steep uphill or downhill gradients, the vehicle must be secured at the rear axle, e.g. with a wheel chock or similar object

Use the wheel chock (▷ page 153) to do so.

Parking brake

⚠ WARNING

If you leave children unsupervised in the vehicle, they could set it in motion by, for example:

- release the parking brake.
- shift the automatic transmission out of the parking position **P**.
- start the engine.

In addition, they may operate vehicle equipment and become trapped. There is a risk of an accident and injury.

When leaving the vehicle, always take the SmartKey with you and lock the vehicle. Never leave children unsupervised in the vehicle.

⚠ WARNING

If you must brake the vehicle with the parking brake, the braking distance is considerably longer and the wheels could lock. There is an increased danger of skidding and accidents.

Only use the parking brake to brake the vehicle when the service brake is faulty. Do not apply the parking brake too firmly. If the wheels lock, release the parking brake until the wheels begin turning again.

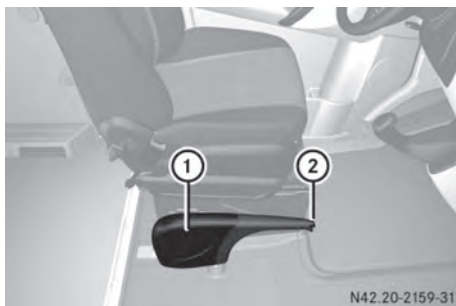

The brake lamps are not illuminated when you brake the vehicle using the parking brake.

As a rule, you may only apply the parking brake when the vehicle is stationary.

► **To apply the parking brake:** pull brake lever ① up as far as the last possible detent.

The  warning lamp in the instrument cluster lights up if the engine is running.

❗ On vehicles with a folding brake lever, you can then press lever ① down to the stop.

► **To release the parking brake:** on vehicles with a folding brake lever, first pull brake lever ① up to the stop.

► Raise brake lever ① slightly and press release knob ②.

► Guide brake lever ① down to the stop.

The  indicator lamp in the instrument cluster goes out.

Exceptionally, if the service brake fails, the parking brake can be used to brake the vehicle in an emergency.

► **Emergency braking:** press and hold release button ② and carefully apply brake lever ①.

Switching off the engine

⚠ WARNING

The automatic transmission switches to neutral position **N** when you switch off the engine. The vehicle may roll away. There is a risk of an accident.

After switching off the engine, always switch to parking position **P**. Prevent the parked vehicle from rolling away by applying the parking brake.

❗ If the coolant temperature is very high, e.g. after driving on hilly roads, leave the engine running at idle speed for about two minutes before turning it off.

This allows the coolant temperature to return to normal.

► Stop the vehicle.

► Shift the automatic transmission to position **P**.

- ▶ Apply the parking brake.
- ▶ Turn the key to position **0** in the ignition lock and remove it. The immobilizer is activated.
- ▶ Secure the vehicle to prevent it from rolling away (▷ page 151).

Wheel chock

Use the wheel chock or a similar object to prevent the vehicle from rolling away, e.g. when parking or changing a wheel.

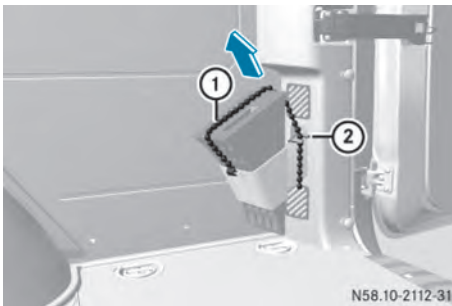

Wheel chock in the load/passenger compartment

- ▶ **To remove the wheel chock on Cargo Vans/Passenger Vans:** pull restraining cable ① down a little and remove it from retainer ②.
- ▶ Remove the chock.
- ▶ **i** When stowing the wheel chock, make sure that restraining cable ① is holding it securely in retainer ②.

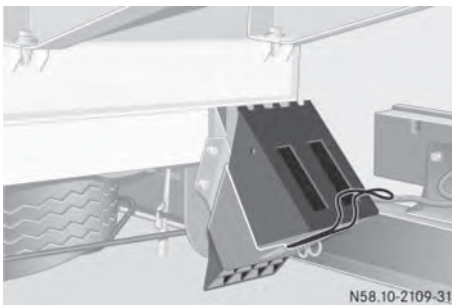

Wheel chock to the rear of the chassis on the left side of the vehicle (example)

- ▶ **To remove the wheel chock on Cab Chassis:** pull the locking springs down and remove the wheel chock.

i When stowing the wheel chock, make sure that it is secured in the retainer with the locking springs.

Parking the vehicle for a long period

If you leave the vehicle parked for longer than 4 weeks, the battery may be damaged by exhaustive discharging.

- ▶ Disconnect the battery (▷ page 262) or switch off the battery main switch (▷ page 136).

Or

- ▶ Connect the battery to a trickle charger. You can obtain information about trickle chargers from a qualified specialist workshop.

If you leave the vehicle parked for longer than 6 weeks, the vehicle may suffer damage as a result of lack of use.

- ▶ Visit a qualified specialist workshop and seek advice.

Driving tips

General notes

Important safety notes

⚠ WARNING

The driver's attention to the road must always be his/her primary focus when driving. For your safety and the safety of others, we recommend that you pull over to a safe location and stop before placing or taking a telephone call. If you choose to use the telephone while driving, please use the hands-free device and only use the telephone when road, weather and traffic conditions permit.

Some jurisdictions prohibit the driver from using a mobile phone while driving a vehicle.

Bear in mind that at a speed of just 30 mph (approximately 50 km/h), your vehicle covers a distance of 44 feet (approximately 14 m) every second.

WARNING

If you switch off the ignition while driving, safety-relevant functions are only available with limitations, or not at all. This could affect, for example, the power steering and the brake boosting effect. You will require considerably more effort to steer and brake. There is a risk of an accident.

Do not switch off the ignition while driving.

! Always observe the ground clearance of the vehicle and avoid obstacles. On vehicles with a step, ground clearance is further restricted. Obstacles can damage the vehicle.

If you must drive over obstacles, drive especially slowly and carefully. If necessary, have another person direct you.

Drive sensibly – save fuel

In order to save fuel, observe the following tips:

- ▶ The tires should always be inflated to the recommended tire pressure.
- ▶ Remove unnecessary loads.
- ▶ Remove roof carriers when they are not needed.
- ▶ Warm up the engine at low engine speeds.
- ▶ Avoid frequent acceleration or braking.
- ▶ Have all maintenance work carried out as indicated by the service intervals in the Maintenance Booklet or by the service interval display.

Fuel consumption also increases when driving in cold weather, in stop-start traffic and in mountainous terrain.

Overrun cutoff

If you are in overrun mode and take your foot off the accelerator pedal, the fuel supply is cut off when the engine speed is out of the idle speed control range.

Drinking and driving

WARNING

Drinking and driving and/or taking drugs and driving are very dangerous combinations. Even a small amount of alcohol or drugs can affect your reflexes, perceptions and judgment.

The possibility of a serious or even fatal accident are greatly increased when you drink or take drugs and drive.

Do not drink or take drugs and drive or allow anyone to drive who has been drinking or taking drugs.

Emission control

WARNING

Combustion engines emit poisonous exhaust gases such as carbon monoxide. Inhaling these exhaust gases leads to poisoning. There is a risk of fatal injury. Therefore never leave the engine running in enclosed spaces without sufficient ventilation.

Certain engine systems are designed to keep the level of poisonous substances in exhaust fumes within legal limits.

These systems only work optimally if they are maintained exactly in accordance with the manufacturer's specifications. Any work on the engine should therefore be carried out by qualified and authorized technicians at a Sprinter dealer.

The engine settings must not be changed under any circumstances. In addition, all specific maintenance work must be carried out at regular intervals and in accordance with the service requirements of the dealer listed

here on the inside title page. Details can be found in the Maintenance Booklet.

Short journey

! If the vehicle is predominantly used for short-distance driving, this could lead to a malfunction in the automatic cleaning function for the diesel particle filter. As a result, fuel may accumulate in the engine oil and cause engine failure.

Therefore, if you mainly drive short distances, you should drive on a highway or on rural roads for 20 minutes every 310 miles (500 km). This ensures sufficient regeneration of the diesel particle filter.

Therefore, if you mainly drive short distances, drive on a freeway or an inter-urban road for 20 minutes every 300 miles (500 km). This facilitates the diesel particle filter's burn-off process.

Speed limiter

WARNING

Exceeding the stated tire load-bearing capacity and the approved maximum speed could lead to tire damage or the tire bursting. There is a risk of accident.

Therefore, only use tire types and sizes approved for your vehicle model. Observe the tire load rating and speed rating required for your vehicle.

As the driver, you must find out about the maximum speed of the vehicle and the resulting permissible maximum speed of the tires (tire and tire pressure). In particular, also observe the tire approval regulations for each country.

You must not exceed the speed limit for the tires listed in the tire pressure tables. You can find information on tire pressures in the "Wheels and tires" section (> page 290).

You can permanently limit the maximum speed of your vehicle to 75 mph (120 km/h). We recommend that you use an authorized Sprinter Dealer for the programming of the maximum speed.

Before overtaking, take into consideration that the engine speed limiter prevents the speed increasing beyond the programmed maximum speed.

Travel abroad

Service

An extensive network of authorized Sprinter Dealers is also at your disposal when you are traveling abroad. Nevertheless, please bear in mind that service facilities or replacement parts may not always be immediately available. You can obtain a list of workshops at any authorized Sprinter Dealer.

Fuel

In some countries, only fuels with a higher sulfur content are available.

Unsuitable fuel can cause engine damage. Information on fuel (> page 320).

Low-beam headlamps

If you are traveling in countries where vehicles are driven on the opposite side of the road to that in which the vehicle is registered, you will need to:

- have the halogen headlamps partially masked
- have the Bi-Xenon headlamps set to symmetrical low beam

This prevents glare to oncoming traffic and no longer illuminates the edge of the road to the same height and distance.

Have the headlamps masked or adjusted at a qualified specialist workshop before you cross the border, but as close to it as possible.

When you return from your journey, and as close to the border as possible, you will need to:

- remove the adhesive surfaces from your halogen headlamps and clean the glass of the headlamps if necessary
- have the Bi-Xenon headlamps reset to asymmetrical low beam at a qualified specialist workshop

Transport by rail

Transporting your vehicle by rail may be subject to certain restrictions or require special measures to be taken in some countries due to varying tunnel heights and loading standards.

You can obtain further information from any authorized Sprinter dealer.

Braking

Important safety notes

WARNING

If you shift down on a slippery road surface in an attempt to increase the engine's braking effect, the drive wheels could lose their grip. There is an increased danger of skidding and accidents.

Do not shift down for additional engine braking on a slippery road surface.

Downhill gradients

- ❗ Depressing the brake pedal constantly results in excessive and premature wear to the brake pads.

On long and steep downhill gradients, you should change down to shift range **2** or **1** in good time. This should be observed in particular when driving with a laden vehicle and when towing a trailer.

- ❗ You must also change the shift range in good time when cruise control is switched on.

You thereby make use of the braking effect of the engine and do not have to brake as often to maintain the speed. This relieves the load on the service brake and prevents the brakes from overheating and wearing too quickly.

Heavy and light loads

WARNING

If you rest your foot on the brake pedal while driving, the braking system can overheat. This increases the stopping distance and can even cause the braking system to fail. There is a risk of an accident.

Never use the brake pedal as a footrest. Never depress the brake pedal and the accelerator pedal at the same time.

- ❗ Depressing the brake pedal constantly results in excessive and premature wear to the brake pads.

If the brakes have been subjected to a heavy load, do not stop the vehicle immediately. Drive on for a short while. The brakes are cooled down more quickly in the airflow.

Wet road surfaces

If you have been driving for a long time in heavy rain without braking, there may be a delayed response when you first apply the brakes. This may also occur after driving through a car wash or deep water.

You must depress the brake pedal more firmly. Maintain a longer distance to the vehicle in front.

While paying attention to the traffic conditions, you should brake the vehicle firmly after driving on a wet road surface or through a car wash. This heats the brake discs, so that they dry more quickly, which protects them against corrosion.

Limited braking performance on salt-treated roads

When driving on salted roads, salt may start to build up on the brake disks and brake pads. This can increase braking distances considerably.

Maintain a greater distance to the vehicle in front.

To remove any build up of salt that may have formed:

- ▶ Apply the brakes at the start of the journey, occasionally during journey and at the end of the journey. Make sure that you do not endanger other road users when doing so.

Parking brake

WARNING

If you must brake the vehicle with the parking brake, the braking distance is considerably longer and the wheels could lock. There is an increased danger of skidding and accidents.

Only use the parking brake to brake the vehicle when the service brake is faulty. Do not apply the parking brake too firmly. If the wheels lock, release the parking brake until the wheels begin turning again.

When driving on wet roads or dirt-covered surfaces, road salt and/or dirt may get into the parking brake. This causes corrosion and a reduction of braking force.

In order to prevent this, drive with the parking brake lightly applied from time to time. When doing so, drive for a distance of approximately 110 yds (100 m) at a maximum speed of 12 mph (20 km/h).

The brake lamps are not illuminated when you brake the vehicle using the parking brake.

Driving in wet conditions

Braking on wet road surfaces

If you have been driving for a long time in heavy rain without braking, there may be a delayed response when you first apply the brakes. This may also occur after driving through a car wash or deep water.

You must depress the brake pedal more firmly. Maintain a longer distance to the vehicle in front.

While paying attention to the traffic conditions, you should brake the vehicle firmly after driving on a wet road surface or through a car wash. This heats the brake discs, so that they dry more quickly, which protects them against corrosion.

Hydroplaning

WARNING

There is a danger of hydroplaning occurring, even if you are driving slowly and your tires have sufficient tread depth, depending on the depth of water on the road. There is a risk of an accident.

For this reason, avoid tire ruts and brake carefully.

Therefore, in heavy rain or other conditions in which hydroplaning can occur, drive as follows:

- reduce your speed
- avoid tire ruts
- apply the brakes with care

Driving on flooded roads

! Do not drive through flooded areas. Check the depth of any water before driving through it. Drive slowly through standing water. Otherwise, water may enter the vehicle interior or the engine compartment. This can damage the electronic components in the engine or the automatic transmission. Water can also be drawn in by the

engine's air suction nozzles and this can cause engine damage.

If you have to drive on stretches of road on which water has collected, please bear in mind that:

- the water level of standing water should not be above the lower edge of the front bumper
- do not drive faster than walking speed

Driving in winter

General notes

WARNING

If you shift down on a slippery road surface in an attempt to increase the engine's braking effect, the drive wheels could lose their grip. There is an increased danger of skidding and accidents.

Do not shift down for additional engine braking on a slippery road surface.

DANGER

If the exhaust pipe is blocked or adequate ventilation is not possible, poisonous gases such as carbon monoxide (CO) may enter the vehicle. This is the case, e.g. if the vehicle becomes trapped in snow. There is a risk of fatal injury.

If you leave the engine or the auxiliary heating running, make sure the exhaust pipe and area around the vehicle are clear of snow. To ensure an adequate supply of fresh air, open a window on the side of the vehicle that is not facing into the wind.

Have your vehicle winterproofed at a qualified specialist workshop in good time at the onset of winter.

-  Do not cover the radiator, e.g. with a winter cover. The measurements of the on-board diagnostic system may otherwise return inaccurate values. Some of these

values are legally prescribed and must therefore always be exact.

Observe the notes in the "Winter operation" section (▷ page 288).

Driving with summer tires

Observe the notes in the "Winter operation" section (▷ page 288).

Slippery road surfaces

WARNING

If you shift down on a slippery road surface in an attempt to increase the engine's braking effect, the drive wheels could lose their grip. There is an increased danger of skidding and accidents.

Do not shift down for additional engine braking on a slippery road surface.

WARNING

The outside temperature indicator is not designed to serve as an ice-warning device and is therefore unsuitable for that purpose.

Indicated temperatures just above the freezing point do not guarantee that the road surface is free of ice. The road may still be icy, especially in wooded areas or on bridges.

-  Vehicles with automatic transmission may roll only briefly in the neutral position **N**. Prolonged rolling of the wheels, e.g. when being towed, will result in transmission damage.

If the vehicle threatens to skid or cannot be stopped when moving at low speed:

- ▶ Shift the transmission to neutral position **N**.
- ▶ Try to maintain control of the vehicle using corrective steering.

Drive particularly carefully on slippery roads. Avoid sudden acceleration, steering and braking maneuvers. Do not use cruise control.

You can find further information on winter tires and snow chains in the "Wheels and tires" section (▷ page 288).

Driving off-road

Important safety notes

WARNING

If you drive on a steep incline at an angle or turn when driving on an incline, the vehicle could slip sideways, tip and rollover. There is a risk of an accident.

Always drive on a steep incline in the line of fall (straight up or down) and do not turn the vehicle.

WARNING

When driving off-road, your body is subject to forces from all directions, due to the uneven surface. You could be thrown from your seat, for instance. There is a risk of injury.

Always wear a seat belt, even when driving off-road.

WARNING

If you drive over obstacles or in ruts, the steering wheel may jerk out of your grip, causing injury to your hands.

Always hold the steering wheel firmly with both hands. When driving over obstacles, you must expect steering forces to increase briefly and suddenly.

WARNING

Flammable material such as leaves, grass or twigs may ignite if they come into contact with hot parts of the exhaust system. There is a risk of fire.

When driving off road or on unpaved roads, check the vehicle's underside regularly. In particular, remove parts of plants or other flammable materials which have become trapped. In the case of damage, contact a qualified specialist workshop.

 When driving off-road or on unpaved surfaces, check the underside of the vehicle and the wheels and tires at regular intervals. In particular, remove any trapped foreign objects, e.g. stones and branches.

Such foreign objects may:

- damage the chassis, the fuel tank or the brake system
- cause imbalances and thus vibrations
- be flung out when you continue driving

If there is any damage, inform a qualified specialist workshop.

 If there are steep gradients while driving off-road, a sufficient filling level in the DEF tank must be ensured. Make sure for this reason that there is a minimum fill level of ten liters before driving off-road.

When driving off-road and on construction sites, sand, mud and water mixed with oil, for example, may get into the brakes. This may lead to a reduction in braking performance or total brake failure, also as a result of increased wear. The braking characteristics will vary depending on the material that has got into the system. Clean the brakes after driving off-road. If you then notice reduced braking performance or hear scraping noises, have the brake system checked at a qualified specialist workshop. Adjust your driving style to the changed braking characteristics.

Driving off-road or on construction sites increases the possibility of vehicle damage which may in turn lead to the failure of certain assemblies and systems. Adapt your driving style to the off-road driving conditions. Drive carefully. Have any vehicle damage rectified at a qualified specialist workshop as soon as possible.

When driving on rough terrain, do not shift the transmission into the neutral position. You could lose control when attempting to brake the vehicle with the service brake. If your vehicle cannot manage an uphill slope, drive back down the slope in reverse gear.

When loading your vehicle for driving off-road or on a construction site, keep the vehicle's center of gravity as low as possible.

Checklist before driving off-road

- ▶ Check the fuel and DEF levels (▷ page 183) and top up (▷ page 150).
- ▶ **Engine:** check the oil level (▷ page 252) and add oil (▷ page 254).
Before driving up or down steep gradients, fill the oil to the maximum level.
- ❗ If you drive up or down steep gradients, the  symbol may appear in the display. The engine operating safety is not put at risk if you have filled the engine oil to the maximum level before the journey.
- ▶ **Vehicle tool kit:** check that the jack is working (▷ page 276).
- ▶ Make sure that a wheel bolt wrench (▷ page 276), wooden underlay for the jack, a robust tow cable and a folding spade are carried in the vehicle.
- ▶ **Wheels and tires:** check the tire tread depth (▷ page 287) and tire pressure (▷ page 290).

Rules for driving off-road

- ❗ Always bear the vehicle's ground clearance in mind and avoid obstacles, e.g. deep ruts.

Obstacles may damage the following parts of the vehicle:

- the chassis
- the drive train
- the fuel and supply tanks

For this reason, you should always drive slowly when driving off-road. If you have to drive over obstacles, have the co-driver direct you.

- ❗ We recommend that you additionally carry a shovel and a recovery rope with shackle in the vehicle.

- Ensure that loads and items of luggage are securely stowed or lashed down (▷ page 242).
- Before driving off-road, stop the vehicle and shift to a low gear.
- If the surface demands it, temporarily deactivate ASR when pulling away (▷ page 60).
- Only drive off-road with the engine running and a gear engaged.
- Drive slowly and smoothly. Walking pace is necessary in many situations.
- Avoid spinning the drive wheels.
- Make sure that the wheels always remain in contact with the ground.
- Drive with extreme care over unknown terrain where you can only see for a short distance. As a precaution, get out of the vehicle to take a look at the route to be taken in advance.
- Check the water depth before fording.
- Watch out for obstacles (e.g. rocks, holes, tree stumps and ruts).
- Avoid edges where the surface could crumble or break away.

Checklist after driving off-road

- ❗ If you detect damage to the vehicle after driving off-road, have the vehicle checked immediately at a qualified specialist workshop.

Off-road driving places a higher demand on your vehicle than normal road operation. Check your vehicle after driving on rough terrain. By doing so you will notice any damage in good time and reduce the risk of an accident for yourself and other road users. Clean your vehicle thoroughly before driving on public roads.

Observe the following points after driving off-road, on construction sites and before driving on public roads:

- ▶ Activate ASR (▷ page 60).
- ▶ Clean the headlamps and tail lamps and check them for damage.

- ▶ Clean the front and rear license plates.
- ▶ Clean the windshield, windows and exterior mirrors.
- ▶ Clean the steps, door sills and grab handles.
This increases safety of footing.
- ▶ Clean the wheels/tires, wheel housings and the underbody of the vehicle with a water jet.
This increases road grip, especially on wet road surfaces.
- ▶ Check the wheels/tires and wheel housings for trapped foreign objects and remove them.
Trapped foreign objects can damage the wheels/tires and may be flung out from the vehicle when you continue driving.
- ▶ Check the underbody for trapped branches or other parts of plants and remove them.
Trapped branches or other parts of plants increase the risk of fire and can cause damage to fuel lines, brake hoses and the rubber bellows of axle joints and drive shafts.
- ▶ Clean the brake disks, brake pads and axle joints, particularly after operation in sand, mud, grit/gravel, water or similarly dirty conditions.
- ▶ Check the entire floor assembly, the tires, wheels, bodywork structure, brakes, steering, chassis and exhaust system for any damage.
- ▶ Check the service brake for operating safety, e.g. carry out a brake test.
- ▶ If you notice strong vibrations after driving off-road, check the wheels and drive train for foreign objects again. Remove any foreign objects which can lead to imbalances and thus cause vibrations.

Driving systems

Cruise control

Important safety notes

Observe the notes on braking in the "Driving tips" section (▷ page 156).

If you fail to adapt your driving style or if you are inattentive, cruise control can neither reduce the risk of an accident nor override the laws of physics. Cruise control cannot take road, weather and traffic conditions into account. Cruise control is only an aid. You are responsible for the distance to the vehicle in front, for vehicle speed and for braking in good time.

Do not use cruise control:

- in traffic conditions that are unsuitable for driving at a constant speed, e.g. in heavy traffic, on winding roads or off-road
- on slippery roads. Braking or accelerating may cause the drive wheels to lose traction and the vehicle could then skid.
- when there is poor visibility, e.g. due to fog, heavy rain or snow

If there is a change of drivers, make sure that you inform the new driver about the set cruise speed.

General notes

Cruise control maintains the speed of the vehicle for you.

Use cruise control if road and traffic conditions make it appropriate to maintain a steady speed for a prolonged period. You can set any speed from 20 mph upwards in increments of 1 mph.

Use cruise control if road and traffic conditions make it appropriate to maintain a steady speed for a prolonged period. You can set any speed from 20 mph upwards in increments of 1 mph.

- i** If you have set km/h as the unit for the digital speedometer (▷ page 192), you can

set any speed from 30 km/h upwards in increments of 1 km/h.

- i** Cruise control should not be activated when driving off-road or on construction sites.

Cruise control may not be able to maintain the stored speed on uphill or downhill gradients. If the gradient evens out and the vehicle's speed does not fall below 20 mph (30 km/h), the stored speed is resumed.

Cruise control lever



- ① To activate and store the current speed or a higher speed
- ② To activate at the last stored speed
- ③ To activate and store the current speed or a lower speed
- ④ To deactivate cruise control

The cruise control lever is the uppermost lever on the left of the steering column.

LIM indicator lamp ⑥ shows you which function you have selected:

- **LIM indicator lamp off:** cruise control is selected.
- **LIM indicator lamp lit:** variable SPEEDTRONIC is selected.

Activation conditions

To activate cruise control, all of the following activation conditions must be fulfilled:

- the parking brake must be released. The  indicator lamp in the instrument cluster is off
 - you are driving faster than 20 mph (30 km/h)
 - the brake pedal is depressed
- i** Other drive and brake systems not described in this Operator's Manual, such as a retarder, may affect cruise control. You can find information on this in the separate operating instructions provided by the body manufacturer.

Storing and maintaining the current speed

- ▶ Accelerate the vehicle to the desired speed above 20 mph (30 km/h).
- ▶ Briefly push the cruise control lever up ① or down ③.
- ▶ Release the accelerator pedal. Cruise control is activated. The current speed is stored.

Resuming the stored speed

WARNING

If you call up the stored speed and it differs from the current speed, the vehicle accelerates or decelerates. If you do not know the stored speed, the vehicle could accelerate or brake unexpectedly. There is a risk of an accident.

Pay attention to the road and traffic conditions before calling up the stored speed. If you do not know the stored speed, store the desired speed again.

- ▶ Briefly pull the cruise control lever towards you ②.
- ▶ Release the accelerator pedal.
Cruise control is activated and resumes the vehicle's speed to the last speed stored.
- i** When you pull the cruise control lever towards you for the first time after starting the engine, cruise control adopts the current speed.

Setting the speed

It may be a moment before the vehicle starts to accelerate or brake to the set speed. Take this delay into account when setting the speed.

- ▶ Briefly push the cruise control lever upwards ① to increase the speed or downwards ③ to reduce the speed.
The last speed stored is increased/reduced in increments of 1 mph (1 km/h).

Or

- ▶ Press and hold the cruise control lever up ① or down ③ until the desired speed has been reached.
- ▶ Release the cruise control lever.
The current speed is stored.
- i** Cruise control is not deactivated if you depress the accelerator pedal. If you accelerate briefly to overtake, for example, cruise control resumes the vehicle's speed to the last speed stored after you have finished overtaking.

Deactivating cruise control

There are various ways to deactivate cruise control:

- ▶ Briefly press the cruise control lever forwards ④.

Or

- ▶ Apply the brakes.

The last speed set remains stored. The last speed stored is deleted when you switch off the engine.

Cruise control is deactivated automatically when:

- you apply the brakes
- you apply the parking brake and the  indicator lamp in the instrument cluster lights up
- you are driving slower than 20 mph (30 km/h)
- you shift the automatic transmission to neutral position **N** while the vehicle is in motion
- ESP[®] or ASR intervenes
- there is a malfunction in the ESP[®], ASR or ABS system

Problems with cruise control

Problem	Possible causes/consequences and ► Solutions
On vehicles with steering wheel buttons, the speed cannot be set when cruise control is activated.	<p>The display is showing a message of high priority and cannot therefore show a change in speed.</p> <ul style="list-style-type: none"> ► Proceed as instructed by the message in the display. ► Deactivate cruise control

Lane Tracking package

Blind Spot Assist

General notes

Blind Spot Assist uses a radar sensor system to monitor the areas on both sides of your vehicle. It supports you from speeds of approximately 20 mph (30 km/h). A warning display in the exterior mirrors draws your attention to vehicles detected in the monitored area. If you then switch on the corresponding turn signal to change lane, you will also receive an optical and audible collision warning. For this purpose, Blind Spot Assist uses sensors in the rear bumper and behind the protective strips of the B-pillars.

Important safety notes

WARNING

Blind Spot Assist does not react to:

- vehicles overtaken too closely on the side, placing them in the blind spot area
- vehicles which approach with a large speed differential and overtake your vehicle

As a result, Blind Spot Assist may not give warnings in such situations. There is a risk of an accident.

Always observe the traffic conditions carefully, and maintain a safe lateral distance.

Blind Spot Assist is only an aid. It may fail to detect some vehicles and is no substitute for attentive driving.

 USA only:

This device has been approved by the FCC as a "Vehicular Radar System". The radar sensor is intended for use in an automotive radar system only. Removal, tampering, or altering of the device will void any warranties, and is not permitted by the FCC. Do not tamper with, alter, or use in any non-approved way.

Any unauthorized modification to this device could void the user's authority to operate the equipment.

Monitoring range of the sensors

In particular, the detection of obstacles can be impaired in the case of:

- dirt on the sensors or anything else covering the sensors
- poor visibility, e.g. due to fog, heavy rain or snow
- narrow and short vehicles, e.g. motorcycles or bicycles
- very wide lanes
- narrow lanes
- vehicles not driving in the middle of their lane
- barriers or other road boundaries

Vehicles in the monitoring range are then not indicated.

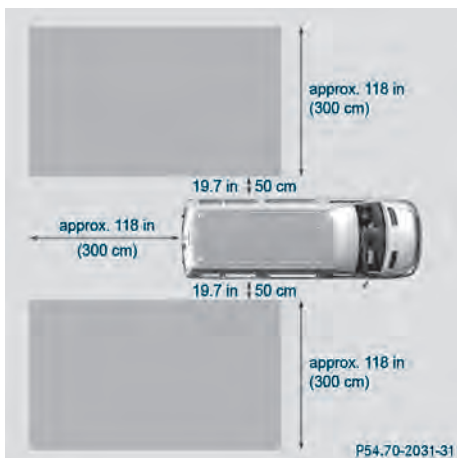

Blind Spot Assist monitors the area approximately 10 ft (3.0 m) behind your vehicle and approximately 11.5 ft (3.5 m) to each side of it. For this purpose, Blind Spot Assist uses radar sensors in the rear bumper and behind the protective strips of the B-pillars.

If the lanes are narrow, vehicles driving in the lane beyond the lane next to your vehicle may be indicated, especially if the vehicles are not driving in the middle of their lane. This may be the case if the vehicles are driving on the inner side of their lane.

Due to the nature of the system:

- a clear warning situation may not occur. The yellow indicator lamp on the relevant side of the vehicle will then light up.
- warnings may be issued in error when driving close to crash barriers or similar solid lane borders.
- warnings may be interrupted when driving alongside particularly long vehicles, for example trucks, for a prolonged time.

The four sensors of Blind Spot Assist are integrated into the rear bumper and behind the protective strips of the B-pillars. Make sure that the bumper and protective stripping are free of dirt, ice or slush in the vicinity of the sensors. The radar sensors must not be covered, for example by cycle racks or overhanging loads.

Have the function of the radar sensors checked at a qualified specialist workshop:

- after a severe impact
- in the event of damage to the bumper
- in the event of damage to the protective strips of the B-pillars

Blind Spot Assist may otherwise not work properly.

Indicator and warning display

Blind Spot Assist is not active at speeds below approximately 20 mph (30 km/h). Vehicles in the monitoring range are then not indicated.

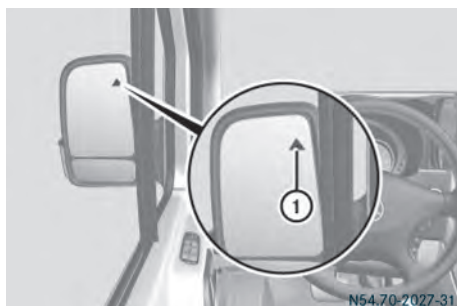

① Yellow indicator lamp/red warning lamp

If yellow indicator lamp ① lights up:

- you are driving at less than 20 mph (30 km/h)
- Blind Spot Assist is deactivated
- Blind Spot Assist is malfunctioning
- there is no clear warning, depending on the situation

Blind Spot Assist is active from a speed of 20 mph (30 km/h). If a vehicle is detected in the blind spot monitoring range, red warning lamp ① on the corresponding side lights up. This warning occurs when a vehicle enters the blind spot monitoring range from behind or from the side. When you overtake a vehicle, the warning only occurs if the difference in speed is less than 14 mph (22 km/h).

Yellow indicator lamp ① goes out if reverse gear is engaged. Blind Spot Assist is then deactivated.



The brightness of the indicator/warning lamps is adjusted automatically according to the ambient light.

Collision warning

If a vehicle is detected in the monitoring range of Blind Spot Assist and you switch on the corresponding turn signal, a double warning tone sounds once. Red warning lamp ① flashes. If the turn signal remains on, detected vehicles are indicated by the flashing of red warning lamp ①. There are no further warning tones.

Activating/deactivating Blind Spot Assist

- i** Blind Spot Assist is activated when you switch on the ignition.

 - ▶ Turn the key to position **2** in the ignition lock.
Warning lamps ① in the exterior mirrors light up red for approximately 1.5 seconds and then turn yellow.
 - ▶ **To deactivate:** press the  button in the center console (▷ page 37).
The yellow indicator lamp in exterior mirror ① first flashes and then lights up continuously. Blind Spot Assist is deactivated.
 - ▶ **To activate:** press the  button in the center console again (▷ page 37).
The yellow indicator lamp in exterior mirror ① flashes initially. If you exceed 19 mph (30 km/h) while driving, the yellow indicator lamp in exterior mirror ① goes out. Blind Spot Assist is activated.

Towing a trailer

If you attach a trailer, make sure that you have correctly established the electrical connection. This can be accomplished by checking the trailer lighting. Blind Spot Assist is then deactivated. The indicator lamp in the exterior mirrors lights up yellow.

On vehicles with steering wheel buttons, the message: **Blind Spot Assist deacti-**

vated also appears in the multifunction display.

Lane Keeping Assist

General notes

Lane Keeping Assist monitors the area in front of your vehicle by means of a camera at the top of the windshield. Lane Keeping Assist detects lane markings on the road and warns you before you leave your lane unintentionally.

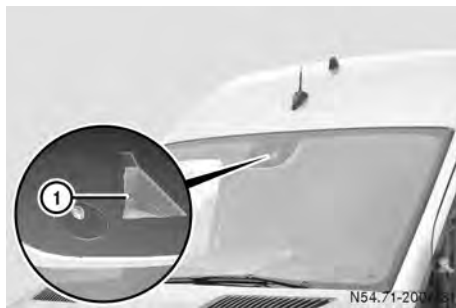

- ① Lane Keeping Assist camera

Lane Keeping Assist supports you from speeds of approximately 40 mph (60 km/h).

Important safety notes

WARNING

Lane Keeping Assist may not always clearly recognize lane markings.

In this case, Lane Keeping Assist may:

- give an unnecessary warning
- not give a warning

There is a risk of an accident.

Always pay particular attention to the traffic situation and stay in lane, in particular if warned by Lane Keeping Assist.

WARNING

The Lane Keeping Assist warning does not return the vehicle to the original lane. There is a risk of an accident.

You should always steer, brake or accelerate yourself, in particular if warned by Lane Keeping Assist.

Lane Keeping Assist may not work properly or may not work at all if the vehicle is incorrectly loaded (▷ page 242).

If you fail to adapt your driving style, Lane Keeping Assist can neither reduce the risk of accident nor override the laws of physics. Lane Keeping Assist cannot take into account road, weather or traffic conditions. Lane Keeping Assist is only an aid. You are responsible for the distance to the vehicle in front, for vehicle speed, braking in good time and for staying in your lane.

Lane Keeping Assist does not keep your vehicle in its lane.

The system may be impaired or may not function if:

- there is poor visibility, e.g. due to insufficient illumination of the road, or due to snow, rain, fog or spray
- there is glare, e.g. from oncoming traffic, the sun or reflection from other vehicles (e.g. if the road surface is wet)
- the windshield is dirty, fogged up, damaged or covered, for instance by a sticker, in the vicinity of the camera
- no, or several, unclear lane markings are present for one lane, e.g. in a construction area
- the lane markings are worn away, dark or covered up, e.g. by dirt or snow
- the distance to the vehicle in front is too small and the lane markings thus cannot be detected
- the lane markings change quickly, e.g. lanes branch off, cross one another or merge
- the road is narrow and winding
- there are highly variable shade conditions on the road

A warning may be given if a front wheel passes over a lane marking. In addition, a

warning tone sounds and the  indicator lamp in the instrument cluster lights up.

Activating/deactivating Lane Keeping Assist

Lane Keeping Assist is automatically activated when you start the engine.

- ▶ **To deactivate:** press the  button in the center console (▷ page 37).

On vehicles without steering wheel buttons:

OFF flashes briefly in the display and the  indicator lamp in the instrument cluster flashes and then lights up continuously.

On vehicles with steering wheel buttons:

The message: **Lane Keeping Assist deactivated** appears in the display and the  indicator lamp in the instrument cluster flashes and then lights up continuously.

Lane Keeping Assist is deactivated.

- ▶ **To activate:** press the  button in the center console again (▷ page 37).

On vehicles without steering wheel buttons:

ON flashes briefly in the display and the  indicator lamp in the instrument cluster flashes and then goes out.

On vehicles with steering wheel buttons:

The message: **Lane Keeping Assist activated** appears in the display and the  indicator lamp in the instrument cluster flashes and then goes out.

Lane Keeping Assist is activated.

A Lane Keeping Assist warning is suppressed if:

- a driving safety system intervenes, such as ABS, BAS or ESP®.
- you have set the turn signal and a lane change is detected. In this case, the warn-

ings are suppressed for a certain period of time.

- you accelerate hard, e.g. kickdown.
- you brake hard.
- you steer actively, e.g. swerve to avoid an obstacle or change lane quickly.
- you cut the corner on a sharp bend.

In order that you are warned only when necessary and in good time if you cross the lane marking, the system recognizes certain conditions and warns you accordingly.

Lane Keeping Assist warns you earlier if:

- you approach the outer lane marking on a bend.
- the road has very wide lanes, e.g. a highway.
- the system recognizes solid lane markings.

Warnings are given later if:

- the road has narrow lanes.
- you cut the corner on a bend.

PARKTRONIC

Important safety notes

PARKTRONIC is only an aid. It cannot replace your own awareness of the immediate surroundings. You are responsible for safe maneuvering, parking and pulling away. When maneuvering, parking and pulling away, make sure that there are no persons, animals or objects in the maneuvering area.

PARKTRONIC does not account for obstacles that are:

- beneath its detection range, e.g. persons, animals or objects
- above its detection range, e.g. overhanging loads, overhangs or truck loading ramps

PARKTRONIC is an electronic parking aid with ultrasonic sensors. It indicates the distance between your vehicle and an object visually and audibly.

Your vehicle features two separate sound emitters with different frequencies for the

warning tones. The warning ranges in front of and behind the vehicle are indicated by different warning tones.

PARKTRONIC is activated automatically when you:

- turn the key to position **2** in the ignition lock
- release the parking brake and
- move the selector lever to **D**, **N** or **R**.

PARKTRONIC is deactivated at speeds above 11 mph (18 km/h). PARKTRONIC is reactivated at speeds below 10 mph (16 km/h).

PARKTRONIC monitors the area around your vehicle with sensors in the front and rear bumpers.

Range of the sensors

! Pay particular attention to obstacles above or below the sensors when parking, such as flower pots or trailer towbars. PARKTRONIC does not recognize such objects when they are in the immediate vicinity of the vehicle. You could damage the vehicle or objects.

PARKTRONIC can suffer interference from:

- ultrasonic sources such as a truck's compressed-air brakes, an automatic car wash or a pneumatic drill
- attachments to the vehicle, e.g. rear mounted racks
- number plates (vehicle license plates) that are not affixed flat against the bumper
- dirty or icy sensors

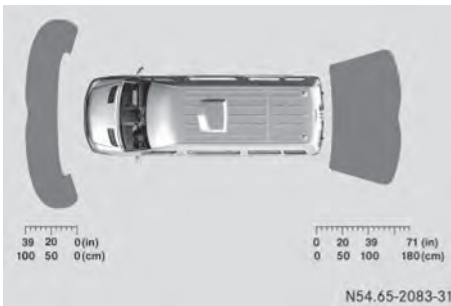
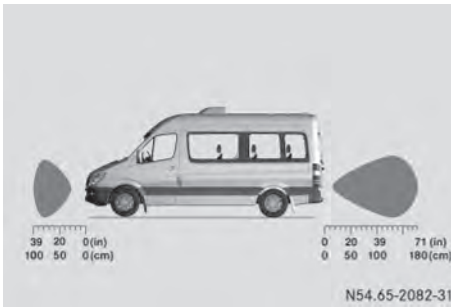

The sensors must be free of dirt, ice or slush. Otherwise, they cannot function correctly. Clean the sensors regularly, taking care not to scratch or damage them (▷ page 270).

Front sensors

Center	Approximately 39 in (100 cm)
Corners	Approximately 26 in (65 cm)

Rear sensors

Center	Approximately 71 in (180 cm)
Corners	Approximately 39 in (100 cm)

Minimum distance

Center	Approximately 12 in (30 cm)
Front corner sensors	Approximately 10 in (25 cm)
Rear corner sensors	Approximately 12 in (30 cm)

If an obstacle is within this range, all segments of the warning displays light up and you hear a warning tone. If the distance between the vehicle and the obstacle falls below the minimum range, it is possible that the distance may no longer be displayed.

Warning displays



Warning display, front area

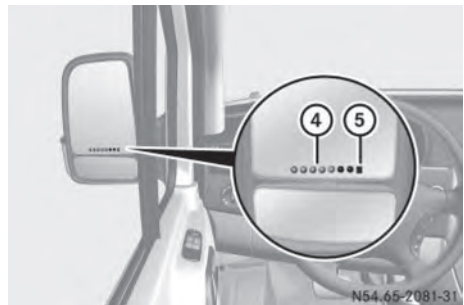

Warning display for the left-hand rear area in the left-hand exterior mirror

- ① Warning segments for the left front area
- ② Warning segments for the right front area
- ③ Operational readiness symbol for the front area

- ④ Warning display segments
- ⑤ Operational readiness symbol for the rear area

The warning displays show the distance between the sensor and the obstacle.

The warning display is divided into five yellow and two red segments for each side of the vehicle. PARKTRONIC is operational if yellow indicator segments ③ and ⑤ are lit.

There is a malfunction if only the red segments of the warning display light up (▷ page 171).

The position of the gear lever determines whether the front and/or rear area is monitored.

Selector lever position	Monitoring
D	Front area
R or N	Front and rear area
P	No areas activated

One or more segments light up as the vehicle approaches an obstacle, depending on the vehicle's distance from the obstacle.

From the:

- sixth segment, an intermittent warning tone sounds for approximately 2 seconds.
- seventh segment, a continuous warning tone sounds. This indicates that you have now reached the minimum distance.

Roll-back warning

PARKTRONIC automatically monitors the area behind the vehicle if the vehicle begins to roll backwards without reverse gear engaged, e.g. after stopping on an uphill gradient.

If PARKTRONIC recognizes an obstacle at a distance of at most 31 in (80 cm), all the segments in the warning displays light up. A continuous warning tone also sounds as the vehicle approaches the obstacle and for a further

2 seconds after the vehicle has come to a halt.

Activating/deactivating PARKTRONIC

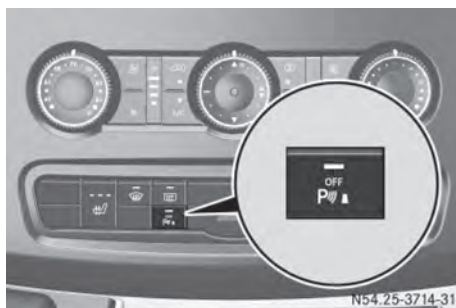

- ▶ Press the  button.

If PARKTRONIC is deactivated, the indicator lamp in the switch lights up.

Towing a trailer

PARKTRONIC detects a coupled trailer if your vehicle is equipped with the corresponding electrical installations for trailer towing. PARKTRONIC is deactivated for the rear area when you establish an electrical connection between your vehicle and a trailer. If you use an adapter for the socket, remove it from the socket after detaching the trailer. Otherwise, PARKTRONIC remains deactivated for the rear area.

Remove a detachable trailer coupling if it is no longer required. PARKTRONIC measures the minimum detection range to an obstacle from the bumper, not the ball coupling.

Problems with PARKTRONIC

Problem	Possible causes/consequences and ► Solutions
<p>Only the red segments in the PARKTRONIC warning displays are lit. A warning tone also sounds for approximately 2 seconds. PARKTRONIC is deactivated after approximately 20 seconds. The indicator lamp of the  button lights up and the red segments in the PARKTRONIC warning display go out.</p>	<p>PARKTRONIC has malfunctioned and has switched itself off.</p> <p>► If problems persist, have PARKTRONIC checked at a qualified specialist workshop.</p>
<p>The PARKTRONIC warning displays implausible distances. For example, all the segments may be lit even though there is no obstacle present.</p>	<p>The PARKTRONIC sensors are dirty or iced up.</p> <p>► Clean the PARKTRONIC sensors (► page 270).</p> <p>► Turn the key to position 2 again in the ignition lock.</p>
	<p>The license plate or other parts attached near the sensors may not be secured correctly.</p> <p>► Check the license plate and attachment parts near the sensors for correct seating.</p>
	<p>An external radio or ultrasonic source may be causing interference.</p> <p>► Check PARKTRONIC functions in a different location.</p>

Rear view camera

Important safety notes

! Objects that are not at ground level appear further away than they actually are, for example:

- the bumper of the vehicle parked behind
- the drawbar of a trailer
- the ball coupling of a trailer tow hitch
- the tail-end of a truck
- slanted posts

Only use the camera guide lines for orientation. Do not get any closer to objects than the lowest horizontal guide line. You may otherwise damage your vehicle and/or the object.

The rear view camera is only an aid. It cannot replace your own awareness of the immediate surroundings. You are responsible for safe maneuvering and parking. When maneuvering and parking, make sure that there are no persons, animals or objects in the maneuvering area.

The rear view camera is a visual parking aid. Information on operation can be found in the separate Audio 15 supplement.

The camera is in the middle of the roof above the high-mounted brake lamp (▷ page 271).

The rear view camera may show obstacles in perspectival distortion, incorrectly or not at all. The rear view camera cannot display all objects located very near and/or under the rear bumper. It does not warn you of a collision, persons or objects.

The area behind the vehicle is displayed in a mirrored fashion, as in the rear-view mirror or the exterior mirrors. The guide lines displayed assist you in backing up.

The function of the rear view camera may be partially or completely impaired in the following circumstances:

- it is raining very heavily or snowing, or it is foggy.
- the parking space is located in a very dark place.
- the camera is exposed to very strong white light. White stripes may appear on the display.
- the surrounding area is illuminated with fluorescent light. The display may flicker.
- if the temperature changes very quickly, for example if you drive into a heated garage in the winter.
- ambient temperatures are very high.
- the camera lens is dirty or obstructed.
- the rear of the vehicle is damaged. In this case, have the position and setting checked at a specialist workshop.

The rear view camera is switched on when you engage reverse gear **R**.

You can find information on cleaning the camera in the "Maintenance and care" section (▷ page 271).

Working mode

ADR (working speed governor)

General notes

When activated, ADR automatically increases the engine speed to a preset speed or a speed you have set.

i After a cold start, the idling speed of the engine is increased automatically. If the preset working speed is lower than the increased idling speed, the working speed is only reached once the engine has completed the warm-up phase.

It is only possible to activate ADR with the vehicle stationary and the parking brake applied.

The selector lever of the automatic transmission must be in position **P**.

Activating/deactivating ADR

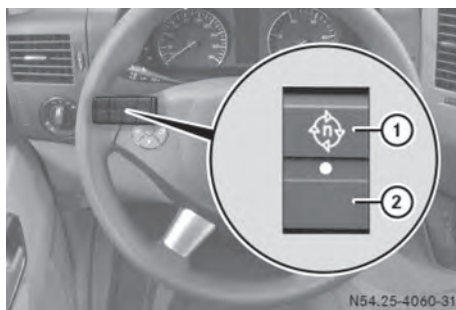

► **To activate:** press upper section ① of the  switch while the engine is running. The indicator lamp in the switch comes on.

The **ADR** indicator lamp in the instrument cluster lights up or the display shows the following message: **Operating speed governor active**.

► **To deactivate:** press lower section ② of the  switch while the engine is running.



The indicator lamp in the switch goes out.

ADR is automatically deactivated if:

- you release the parking brake.
- the brake pedal is depressed.
- the vehicle moves.
- the control unit detects a malfunction.

Setting the working speed



- ▶ Activate ADR.
- ▶ **To increase:** press the  button.
- ▶ **To decrease:** press the  button.

Towing a trailer

Notes on trailer towing

Important safety notes

WARNING

If you install a ball coupling other than the one delivered with the vehicle, the trailer tow hitch and the rear axle may be overloaded. This applies especially if the ball coupling in question is longer or angled differently. This could seriously impair the driving characteristics and the trailer can come loose. There is a risk of an accident.

Only install the ball coupling delivered with the vehicle or a ball coupling that is designed to meet your trailer towing requirements. Do not modify the ball coupling or the trailer tow hitch.

WARNING

If you use a ball coupling that is not approved for your vehicle, it may cause excessive strain on the trailer tow hitch. This can cause damage to the vehicle and the trailer may come loose during the journey. The handling may be impaired and the rear axle may be overloaded. This may lead to an accident involving serious or even fatal injury.

Therefore note the following:

- Only install a ball coupling that is approved for your vehicle.
- Before the journey, make sure that the ball coupling is correctly installed and secured. To do this, observe the operating instructions of the ball coupling manufacturer.
- Do not make any modifications to the ball coupling or the trailer tow hitch.

You must observe the operating instructions of the trailer tow hitch or ball coupling manufacturer.

WARNING

If the ball coupling is not correctly installed and secured, it could come loose while driving and endanger other road users. There is a risk of an accident and injury.

Install and secure the ball coupling as described in the ball coupling manufacturer's installation instructions. Make sure that the ball coupling is correctly installed and secured before every journey.

WARNING

When the vehicle/trailer combination begins to lurch, you could lose control of it. The vehicle/trailer combination could even rollover. There is a risk of an accident.

On no account should you attempt to straighten up the vehicle/trailer combination by increasing the speed. Reduce vehicle speed and do not countersteer. Apply the brake as necessary.

⚠ WARNING

If you rest your foot on the brake pedal while driving, the braking system can overheat. This increases the stopping distance and can even cause the braking system to fail. There is a risk of an accident.

Never use the brake pedal as a footrest. Never depress the brake pedal and the accelerator pedal at the same time.

! Depressing the brake pedal constantly results in excessive and premature wear to the brake pads.

Always observe the operating instructions provided by the manufacturers of the trailer coupling and the ball coupling.

Couple and decouple the trailer carefully. When backing up the towing vehicle, make sure nobody is standing between the vehicle and the trailer.

A trailer which is incorrectly coupled to the towing vehicle could break away. A correctly coupled trailer must be positioned horizontally behind the towing vehicle.

Ensure that the following weights are not exceeded:

- the permissible noseweight
- the permissible trailer load
- the permissible rear axle load of the towing vehicle
- the permissible gross weight of both the towing vehicle and the trailer
- the permissible gross combination weight

The applicable permissible values that may not be exceeded can be found:

- in your vehicle documents
- on the type plates for the trailer tow hitch
- on the type plates for the trailer
- on the vehicle identification plate (> page 319).

Where the values differ, the lowest is valid. You will find values approved by the manufacturer on the identification plates and those for the towing vehicle in the "Permissible

trailer loads and trailer drawbar noseweights" section (> page 178).

Your vehicle behaves differently with a trailer than without one.

The vehicle/trailer combination:

- is heavier
- is restricted in its acceleration and gradient-climbing capability
- has an increased braking distance
- is more susceptible to strong crosswinds
- requires more sensitive steering
- has a larger turning circle

This may impair the handling characteristics.

When towing a trailer, always adjust your speed to suit the road and weather conditions. Drive carefully. Maintain a safe distance.

If you require any further explanation of the information contained in the Operating Instructions, please contact an authorized Sprinter dealer.

General notes

- Observe the legally prescribed maximum speed for vehicle/trailer combinations in the relevant country, state or Canadian province. Before setting off, check the vehicle documents of the your trailer to find out the permissible maximum speed.

This reduces the risk of accidents.

- Install only an approved trailer coupling on your vehicle. Only use a ball coupling that is approved for your vehicle and Sprinter trailer tow hitch. More information on the availability, mounting and installation of the trailer electrics is available at any qualified specialist workshop.
- The turn signals on the trailer are only guaranteed to function when incandescent bulbs are used. You can obtain more information about installing the trailer electrics at any qualified specialist workshop.
- The trailer coupling is one of the most important vehicle parts with regard to road

safety. The notes on operation, care and maintenance issued by the manufacturer should be observed.

- The bumpers of your vehicle are not suitable for installing detachable trailer couplings.
- Do not install rented trailer couplings or other detachable trailer couplings to the bumpers.
- Minimize the risk of damage to the ball coupling. If you do not require the ball coupling, remove it from the ball coupling recess.

Weight information can be found in the "Permissible trailer and drawbar noseweights" section (▷ page 178).

- i** The height of the ball neck changes according to the load on the vehicle. If this is case, use a trailer with a height-adjustable trailer drawbar.

Driving tips

The maximum permissible speed for vehicle/trailer combination depends on the type of trailer. Before setting off, check the vehicle documents of the your trailer to find out the permissible maximum speed. Observe the legally prescribed maximum speed for vehicle/trailer combinations in the relevant country, state or Canadian province.

When towing a trailer, your vehicle's handling characteristics will be different in comparison to when driving without a trailer and it will consume more fuel.

On long, steep downhill slopes you must select shift range **3**, **2** or **1** in good time.

- i** This also applies if cruise control is activated.

This enables you to utilize the engine's braking effect and you do not need to brake so heavily to keep the correct speed, which protects the brake system and prevents the brakes from overheating and wearing too quickly. If you need to brake additionally, to not depress the brake pedal constantly, but periodically.

Driving tips

If the trailer begins to swing from side to side:

- ▶ Do not accelerate.
- ▶ Do not counter-steer.
- ▶ Brake if necessary.
- i** You can reduce the risk of the trailer swinging and rocking by retrofitting anti-roll bars or trailer stability programs. More information is available from your authorized Sprinter Dealer.
- Maintain a greater distance than you would when driving without towing a trailer.
- Avoid sudden braking. Apply the brakes gently at first to allow the trailer brake to overrun. Then, increase the brake force quickly.
- The figures for the gradient climbing capabilities from a standstill refer to sea level. When driving in mountainous areas, note that the power output of the engine, and with it its gradient climbing capability, decrease with increasing altitude.

Attaching and removing the ball coupling

WARNING

If the ball coupling is not correctly installed and secured, it could come loose while driving and endanger other road users. There is a risk of an accident and injury.

Install and secure the ball coupling as described in the ball coupling manufacturer's installation instructions. Make sure that the ball coupling is correctly installed and secured before every journey.

WARNING

If the ball coupling is not installed and secured correctly the trailer may come loose. There is a risk of an accident.

Install and secure the ball coupling as described in the ball coupling installation instructions. Make sure that the ball coupling is

installed and secured correctly before every journey.

If your vehicle is equipped with a Sprinter trailer tow hitch, you need a ball coupling that is approved for the trailer tow hitch.

When mounting and removing the approved ball coupling, observe the relevant information in the operating instructions of the ball coupling manufacturer.

If you cannot mount the ball coupling correctly, remove it. In this case, the ball coupling may not be used for towing a trailer.

Notes on the permissible dimensions and weights can also be found on the identification plate of the trailer tow hitch. You can obtain advice from a qualified specialist workshop.

Coupling up a trailer

! Do not connect the trailer's brake system (if featured) to the hydraulic brake system of the towing vehicle, as the latter is equipped with an anti-lock brake system. Doing so will result in a loss of function of the brake systems of both the vehicle and the trailer.

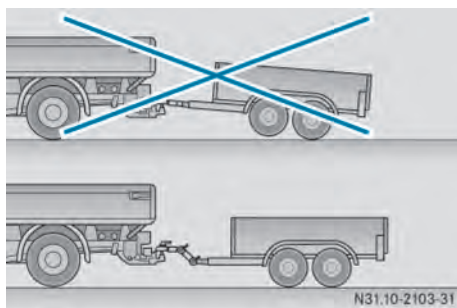

Trailer coupled ready for use

- ▶ Make sure the selector lever of the automatic transmission is in position **P**.
- ▶ Apply the parking brake of the vehicle.
- ▶ Close all doors.

- ▶ Position the trailer horizontally behind your vehicle.

i The height of the ball neck changes according to the load on the vehicle. In this case, use a trailer with a height-adjustable trailer drawbar.

- ▶ Couple the trailer.
- ▶ Establish all electrical and other connections to the trailer.
- ▶ Remove the objects that are preventing the trailer from rolling, e.g. wheel chocks.
- ▶ Release the trailer parking brake.

i The subharness of the vehicle has a cable connection to the brake lamp indicator lamp.

Observe the maximum permissible trailer dimensions (width and length).

Most federal states and all Canadian provinces require by law:

- safety chains between the towing vehicle and the trailer. The chains should be cross-wound under the trailer drawbar. They must be fastened to the vehicle's trailer coupling, not to the bumper or the axle. Leave enough slack in the chains. This allows you to drive round tight corners.
- a separate brake system for certain types of trailer.
- a safety switch for braked trailers. Find out the specific requirements according to the applicable laws.

If the trailer detaches from the towing vehicle, the safety switch applies the trailer's brakes.

Towing a trailer

There are numerous legal requirements concerning the towing of a trailer, e.g. speed restrictions. Make sure your vehicle/trailer combination complies with local laws. This not only means where you live, but also anywhere you are driving to. Information is available from the police and local authorities.

Observe the following when towing a trailer:

- Practice driving around bends, stopping and backing up at a place where there is no traffic. This enables you to gain experience and get used to the new handling characteristics.
- Before driving, check:
 - that the trailer tow hitch and ball coupling are secure
 - that the safety switch for a braked trailer is functioning properly
 - that the safety chains are secure and not damaged
 - that the electrical connections are secure
 - that the lights are working
 - that the wheels are in good order and the tire pressure is correct
- Adjust the exterior mirrors to provide an unobstructed view of the rear section of the trailer.
- If the trailer has electronically controlled brakes, pull the vehicle/trailer combination away carefully. Brake manually using the brake controller and check that the brakes are working.
- Secure the load on the trailer according to the applicable specifications and current standards on securing loads (> page 244).
- When driving with a trailer, check at regular intervals that the load is secured and that the brakes and lights are working.
- Bear in mind that the handling will be less stable when towing a trailer than when driving without one. Avoid sudden steering movements.
- The vehicle/trailer combination is heavier, accelerates more slowly and has a decreased gradient climbing capability and a longer braking distance. It is more susceptible to crosswinds and requires cautious steering.
- If possible, do not brake suddenly, but rather moderately at first so that the trailer

can activate its brakes. Then increase the force on the brake pedal.

- If the automatic transmission repeatedly shifts between gears when driving on inclines, restrict the shift range. Select shift range **4, 3, 2** or **1**.

Driving in a low gear and at a low speed reduces the risk of damaging the engine.

- When driving on a downhill gradient, shift to a low gear and take advantage of the engine's braking effect.

Avoid continuous brake application as this may overheat the vehicle brakes and, if installed, the trailer brakes.

- If the coolant temperature increases dramatically while the air-conditioning system is switched on, switch off the air-conditioning system.

Coolant heat can also be dissipated by switching the airflow and the temperature of the heater/air conditioning to the maximum level. Open the windows if necessary.

- When overtaking, pay particular attention to the extended length of your vehicle/trailer combination.

Due to the length of your vehicle/trailer combination you need an additional distance before you can return to your original lane.

Uncoupling a trailer

WARNING

If you uncouple a trailer with the overrun brake engaged, you could trap your hand between the vehicle and the trailer drawbar. There is a risk of injury.

Do not uncouple a trailer if the overrun brake is engaged.

- ! Do not disconnect a trailer with an engaged overrun brake. Otherwise, your vehicle could be damaged by the rebounding of the overrun brake.

- ▶ Make sure the selector lever of the automatic transmission is in position **P**.
- ▶ Apply the parking brake of the vehicle.
- ▶ Close all doors.
- ▶ Apply the parking brake of the trailer.
- ▶ In addition, secure the trailer against rolling away with a wheel chock or similar object.
- ▶ Remove the trailer cable and safety chains and decouple the trailer.

Permissible trailer loads and trailer drawbar noseweights

Weight information

! On vehicles with a permissible gross vehicle weight of 11030 lbs (5003 kg), the permissible gross combination weight is less than the total of the permissible gross vehicle weight and the permissible trailer load. Exceeding the permissible gross combination weight can lead to damage to the drivetrain, to the transmission or to the trailer tow hitch.

If the vehicle or the trailer is fully laden, the relevant value for the permissible gross vehicle weight or the permissible trailer load is therefore lower. In this case, the trailer or the vehicle may only be partially loaded.

The gross trailer weight (GTW) is calculated by adding the weight of the trailer to the weight of the load and equipment.

The maximum gross vehicle weight is vehicle-specific and equipment-dependent: 5,000 lbs (2,268 kg) or 7,500 lbs (3,402 kg).

The maximum permissible trailer drawbar noseweight on the ball coupling is 500 lbs (227 kg) or 750 lbs (340 kg). The actual noseweight may not exceed the value given on the identification plates of the trailer tow hitch or the trailer. If the values vary, the lowest value always applies.

The gross combination weight rating (GCWR) is calculated by adding the gross weight of the

trailer to the gross vehicle weight including a driver's weight of approximately 150 lbs (68 kg). The permissible Gross Combination Weight Rating is vehicle-specific and depends on the equipment level.

When driving with a trailer, you should not exceed the permitted Gross Combination Weight Rating (GCWR).

The permissible values, which must not be exceeded, can be found in your vehicle documents and on the trailer tow hitch type plates for the trailer and the vehicle (▷ page 319). The basic values approved by the manufacturer can also be found in the "Technical data" section (▷ page 332). If the values vary, the lowest value always applies.

Loading a trailer

! Utilize the maximum permissible noseweight as fully as possible. Do not allow the weight to fall below the minimum permissible noseweight, otherwise the trailer may come loose.

- You must distribute the load on the vehicle and trailer so that the permitted maximum values for the gross vehicle weight (GVWR), gross trailer weight (GTW) and gross combined weight (GCWR) as well as permitted gross axle loads (GAWR) and noseweight (TWR) of your vehicle are not exceeded.
- Add the drawbar noseweight on the ball coupling (TWR) to the rear axle load. This will prevent you from exceeding the permissible gross axle weight (GAWR).
- Add the drawbar noseweight on the ball coupling (TWR) to the vehicle payload. This will prevent you from exceeding the permissible gross vehicle weight (GVWR).

Checking the vehicle and trailer weight

- Make sure the weights of the towing vehicle and the trailer comply with the maximum permissible values. Have the vehicle/trailer combination weighed on a calibrated weighbridge. The vehicle/trailer combina-

tion consists of the towing vehicle including the driver, passengers and load, as well as the loaded trailer.

- Check the maximum permissible gross axle weight rating of the front and rear axles (GAWR), the gross trailer weight (GTW), the gross combination weight rating (GCWR) and the noseweight of the trailer drawbar (TWR).

Trailer power supply

! Incorrect wiring of the connector plug could, under certain circumstances, cause malfunctions in the vehicle's other electronic systems. We therefore recommend having the connector plug wired at a qualified specialist workshop.

! You can connect accessories with a maximum power consumption of 240 W to the permanent power supply.

You must not charge a trailer battery using the power supply.

Your vehicle may be equipped with various electrical installations for trailer towing.

Depending on your trailer, you may need an adapter to connect the electrical system of the trailer with that of the vehicle.

The trailer socket of your vehicle is equipped at the factory with a permanent power supply.

The permanent power supply is on the trailer socket pin assignment 4.

Note that the permanent power supply of the trailer is not switched off when the on-board voltage is low. This can completely discharge the starter battery of your vehicle.

The turn signals on the trailer are only guaranteed to function when incandescent bulbs are used.

Further information on the electrical equipment currently installed on your vehicle and on installing trailer electrics can be obtained at any qualified specialist workshop.

Useful information	182
Important safety notes	182
Instrument cluster	182
On-board computer (vehicles without steering wheel buttons)	184
On-board computer (vehicles with steering wheel buttons)	186
Display messages	199
Indicator and warning lamps in the instrument cluster	221

Useful information

This Operator's Manual describes all models as well as standard and optional equipment of your vehicle that were available at the time of going to print. Country-specific variations are possible. Note that your vehicle may not be equipped with all of the described functions. This also applies to systems and functions relevant to safety.

Read the information on qualified specialist workshops (▷ page 26).

Important safety notes

⚠ WARNING

If you are driving and reach through the steering wheel to operate the adjustment knob, you could lose control of the vehicle. There is a risk of an accident and injury.

Only operate the adjustment knobs when the vehicle is stationary. Do not reach through the steering wheel when driving.

⚠ WARNING

If you operate information systems and communication equipment integrated in the vehicle while driving, you will be distracted from traffic conditions. You could also lose control of the vehicle. There is a risk of an accident.

Only operate the equipment when the traffic situation permits. If you are not sure that this is possible, park the vehicle paying attention to traffic conditions and operate the equipment when the vehicle is stationary.

⚠ WARNING

If the instrument cluster has failed or malfunctioned, you may not recognize function restrictions in systems relevant to safety. The operating safety of your vehicle may be impaired. There is a risk of an accident.

Drive on carefully. Have the vehicle checked at a qualified specialist workshop immediately.

If uncertainties regarding the operating safety of the vehicle arise when continuing the journey, stop the vehicle, paying attention to road and traffic conditions.

Instrument cluster

Overview



- ① Instrument cluster on vehicles without steering wheel buttons
- ② Instrument cluster in vehicles with steering-wheel buttons
- ③ \oplus/\ominus adjustment button, M menu button, O reset button, S service button (engine oil level check)

You will find a full overview of the instrument cluster in the "At a glance" section (▷ page 34).

The display in the instrument cluster is activated when you:

- open the driver's door
- turn the key to position **2** in the ignition lock
- press the O reset button
- switch on the lights

The display switches off automatically after approximately 30 seconds if:

- the vehicle lighting is not switched on.
- the key is in position **0** in the ignition lock.

Instrument lighting

When the lights are switched on, you can adjust the brightness of the instrument cluster lighting using the **+** and **-** buttons.

► **To brighten:** press the **+** button.

► **To dim:** press the **-** button.

- i** Vehicles with automatic headlamp mode: the instrument lighting also adapts to automatic headlamp mode.

Tachometer

! Do not drive in the overrevving range, as this could damage the engine.

Environmental note

Avoid driving at high engine speeds. This unnecessarily increases the fuel consumption of your vehicle and harms the environment as a result of increased emissions.

The red band in the tachometer indicates the engine's overrevving range.

To protect the engine, the fuel supply is interrupted when the red band is reached.

Outside temperature

You should pay special attention to road conditions when temperatures are around the freezing point.

On vehicles without steering wheel buttons (► page 184) and on vehicles with steering wheel buttons (► page 189), the outside temperature display is in the display.

Changes in the outside temperature are displayed after a short delay.

Speedometer

The speed can also be shown in the display. You can find information on the digital speedometer for vehicles without steering wheel buttons under (► page 184) and for vehicles

with steering wheel buttons under (► page 189).



- i** In some countries, a warning sounds when the vehicle reaches the maximum speed limit, e.g. at 75 mph (120 km/h).

Trip odometer

- **To reset:** make sure that the display is showing the trip odometer if you have a vehicle with steering wheel buttons (► page 189).
- Press and hold the **⊖** reset button until the trip odometer is reset to **0.0**.

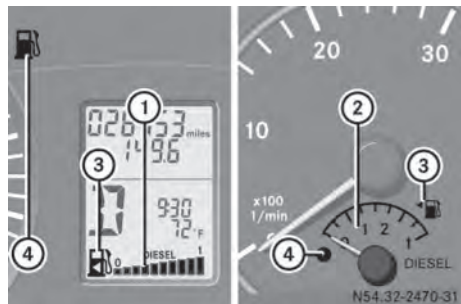

Fuel gage





- ① Fuel gage on vehicles without steering wheel buttons
- ② Fuel gage on vehicles with steering wheel buttons
- ③ Fuel filler flap location indicator : the fuel filler flap is on the left-hand side. Fuel filler flap location indicator : the fuel filler flap is on the right-hand side
- ④ Reserve fuel warning lamp (► page 227)

DEF gauge

Vehicles without steering wheel buttons

If the supply of DEF is less than 1.5 US gal (5.5 l), the  indicator lamp lights up and the  DEF Chk display message appears.

If the supply of DEF falls below the reserve range of 0.8 US gal (3.0 l), the  indicator lamp lights up and the  StArts REXx display message appears. In the display, xx corresponds to the number of possible remaining engine starts (16 to 0).

Further information on DEF consumption can be found in the "Service products and filling capacity" section (> page 324).

Vehicles with steering wheel buttons

If the supply of DEF is less than 1.5 US gal (5.5 l), the [Check Diesel Exhaust Fluid See Operator's Manual](#) message is shown in the display.

If the supply of DEF falls below the reserve range of 0.8 US gal (3.0 l), the  xx starts remaining message is displayed. In the display, xx corresponds to the number of possible remaining engine starts (16 to 0). Further information on DEF consumption can be found in the "Service products and filling capacity" section (> page 324).

On-board computer (vehicles without steering wheel buttons)

Operating the on-board computer

General notes

The on-board computer is activated as soon as you turn the key to position 1 in the ignition lock.

The on-board computer shows vehicle information and settings in the display.

You can control the display and the settings in the on-board computer using the adjustment buttons on the instrument cluster.

Standard display

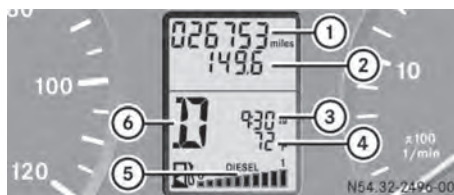

- ① Odometer
- ② Trip odometer
- ③ Clock
- ④ Outside temperature or digital speedometer
- ⑤ Fuel gage (> page 183)
- ⑥ Selector lever position or current shift range with automatic transmission (> page 144)

► **To call up the standard display:** turn the key to position 2 in the ignition lock.

► Press the  menu button for longer than one second.

The information shown in the display changes from the outside temperature to the digital speedometer.

Menus in the on-board computer





Overview

If you wish to exit a menu and go to the standard display:

► Press the  menu button for longer than 1 second.







Or



► Do not press any button for 10 seconds. The display accepts the changed settings.

Using the , ,  or  adjustment buttons, you can select the following functions:





- Calling up the service due date (▷ page 260)
- Checking the oil level (▷ page 252)
- Checking the DEF supply (▷ page 184)
- Preselecting/setting the auxiliary heating switch-on time (▷ page 124)
- Tire pressure monitor (▷ page 293)
- Setting the time (▷ page 185)
- Activating/deactivating Highbeam Assist (▷ page 194)
- Setting the daytime running lamps (▷ page 185)

Setting the time

- ▶ Turn the key to position **2** in the ignition lock.
- ▶ Press the  menu button repeatedly until the hours figure flashes.
- ▶ Press the  or  button to set the hour.
- ▶ Press the  reset button. The minute display flashes.
- ▶ Press the  or  button to set the minute.

i If you keep the  or  button pressed, the value will change continuously.





Activating/deactivating Highbeam Assist

- ▶ Turn the key to position **2** in the ignition lock.
- ▶ Press the  menu button repeatedly until the  indicator lamp flashes and the **on** or **OFF** message appears in the display.
- ▶ Use the  or  button to switch Highbeam Assist on/off.



Switching the daytime running lamps on/off

If you switch the daytime running lights **ON**, the daytime running lights will automatically light up when the engine is running.



For safety reasons, it is only possible to change this setting when the vehicle is stationary. The factory setting is **ON** in countries in which constant headlamp mode or daytime running lights are mandatory.

- ▶ Turn the key to position **2** in the ignition lock.
- ▶ Press the  menu button repeatedly until the  indicator lamp flashes and the **on** or **OFF** message appears in the display.
- ▶ Press the  or  button to activate or deactivate the daytime running lamps.

i USA only:

If you turn the light switch to  or , the corresponding light switches on. If you turn the light switch to **AUTO**, the daytime running lamps remain switched on.

Canada only:

If you turn the light switch to , the low-beam headlamps switch on. If you turn the light switch to  or **AUTO**, the daytime running lamps remain switched on.

On-board computer (vehicles with steering wheel buttons)

Operating the on-board computer

Overview

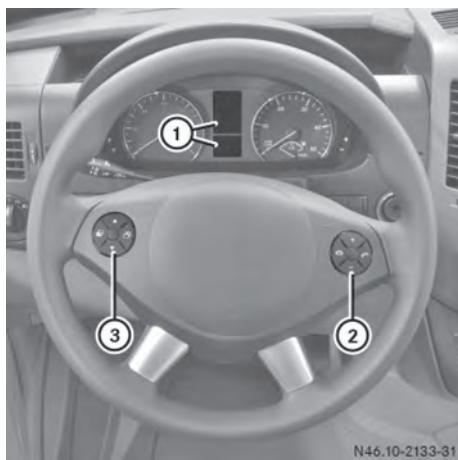

- ▶ **To activate the on-board computer:** turn the key to position **1** in the ignition lock.

The on-board computer is activated as soon as you turn the key to position **1** in the ignition lock.

The on-board computer shows vehicle information and settings in the display.

You can control the display and the settings in the on-board computer with the buttons on the steering wheel.

Steering wheel buttons

①	Display
	On-board computer operation

- ② and

- Selects submenus
- Changes values
- Adjusts the volume

Using the telephone

- Accepts a call
- Ends a call

- ③ Scrolls from one menu to another

- Forwards
- Back

Scrolls within a menu

- Forwards
- Back

Controls

You can think of the order of the menus and of the functions within a menu as a circle:

- ▶ Press the or button repeatedly. The menus are displayed one after the other.
- ▶ Press the or button repeatedly. The functions in the menu/submenu are displayed one after the other.

Several functions are combined thematically in the menus.

The display changes when you press one of the buttons on the steering wheel. You can use a function to call up information or to change the settings for the vehicle.

For example, the **AUDIO** menu has functions for controlling the radio or CD player.

Unlike in other menus, you will find submenus in the **Settings** menu. For information on how to use these submenus, see the "Settings menu" section (▶ page 190).

The number of menus depends on your vehicle's equipment.

- i** Operation of the audio equipment using the steering wheel buttons and making settings using the **AUDIO** menu only function

with Sprinter audio equipment. If you are using audio equipment from another manufacturer, the described functions may be restricted or not available at all.

Menu Overview

Diagrams

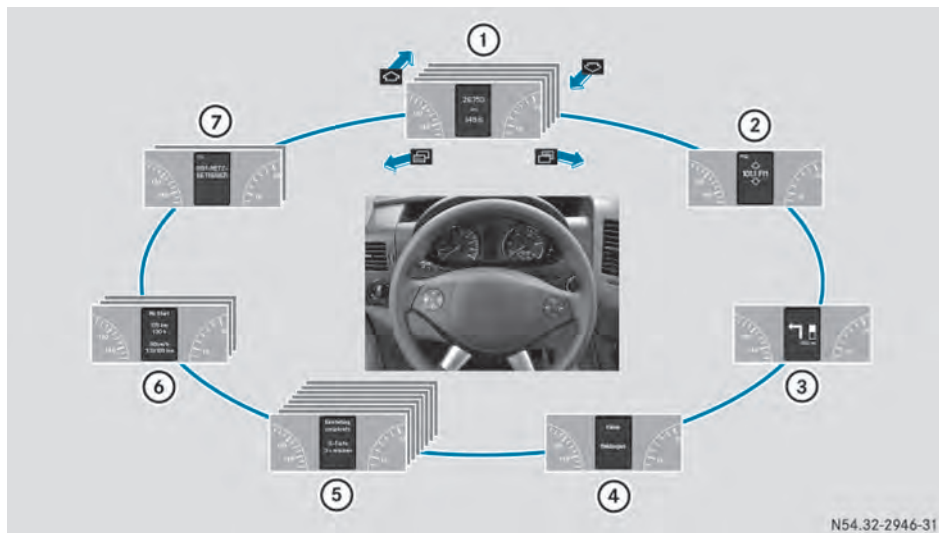

N54.32-2946-31

This is what the displays look like when you scroll through the menus.

Generic terms

The illustration shows the menus on a vehicle with Audio 15.

On Sound 5/Audio 20, the on-board computer always shows the **AUDIO** and **TEL** (telephone) menus in English. This is the case even if a different language is selected for the display.

	Operation
①	Operation menu (▷ page 188) <ul style="list-style-type: none"> • Standard display • Calling up the service due date (▷ page 260) • Tire pressure monitor (▷ page 293) • Checking the engine oil level (▷ page 252)
②	Audio menu (▷ page 189)
③	Message memory menu (▷ page 200)



Operation

- | | |
|---|---------------------------------|
| ④ | Settings menu (▷ page 190) |
| ⑤ | Trip computer menu (▷ page 197) |
| ⑥ | Telephone menu (▷ page 198) |

i The generic terms in the tabular overview should make orientation easier for you. However, they are not always shown on the display.

Operation menu

Overview

You can select the following functions in the **Operation** menu by pressing the  or  buttons on the steering wheel:

- Displaying the trip odometer and odometer (standard display) (▷ page 189)
- Displaying the coolant temperature (▷ page 189)
- Calling up the service due date (▷ page 260)
- Tire pressure monitor (▷ page 293)
- Checking the oil level (▷ page 252)

Standard display



- ① Odometer
- ② Trip odometer
- ③ Outside temperature or digital speedometer
- ④ Clock
- ⑤ Selector lever position or current shift range (▷ page 144)

In the basic setting, the odometer and the trip odometer are shown in the upper part of the display. This is referred to as the standard display.





Using the steering wheel buttons

- ▶ Press the  or  button repeatedly until the standard display is shown .

Displaying the coolant temperature



Using the steering wheel buttons

- ▶ Press the  or  button repeatedly until the standard display is shown .
- ▶ Press the  or  button to select the coolant temperature.

The temperature displayed may climb to 250 °F (120 °C) when the vehicle is being driven in normal conditions and if the coolant contains the correct concentration of corrosion inhibitor and antifreeze. At high outside temperatures and when driving in mountainous terrain, the coolant temperature may rise to the end of the scale.

Audio menu

General notes

Use the functions in the **Audio** menu to operate the audio equipment when switched on.

The settings in the **AUDIO** menu, as well as the audio equipment control system via the steering wheel buttons, only function as described if Sprinter audio equipment has been installed. If you are using audio equipment from another manufacturer, the described functions may be restricted or not available at all.

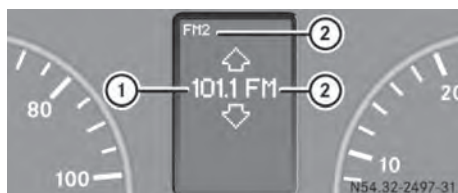

If no audio equipment is switched on, you will see the message **AUDIO off**.

Selecting a radio station



- ① Reception frequency
- ② Waveband or waveband with memory preset number

Using the steering wheel buttons

- ▶ Switch on the audio equipment (see the separate operating instructions).
- ▶ Press the  or  button repeatedly until the station selected appears in the display.

The type of search depends on the setting of the radio station selection (▷ page 196): the nearest stored station will be selected or the station search starts.

- ▶ Press the  or  button to select the desired station.

i You can only store new stations on the audio system itself. See the separate operating instructions.





You can also operate the audio equipment in the same way as usual.

Operating the CD player



- ① Current CD (with CD changer)
- ② Current track

Using the steering wheel buttons

- ▶ Switch on the audio equipment and select the CD player (see the separate operating instructions).
- ▶ Press the  or  button repeatedly until the settings for the current CD appear in the display.
- ▶ Press the  or  button to select a CD track.

Settings menu

Introduction

In the **Settings** menu, the following options and submenus are available:

- Resetting all settings
- Resetting the functions of a submenu
- Instrument cluster (▷ page 191)
 - Units and language settings
 - Status bar settings
- Clock (▷ page 193)
- Lighting (▷ page 194)
 - Switching surround lighting on/off
 - Switching the daytime running lamps on/off
 - Setting the exterior lighting delayed switch-off
 - Activating/deactivating Highbeam Assist
- Vehicle (▷ page 196)
 - Setting the radio station selection
 - Setting the windshield wiper sensitivity
- Stationary heating or auxiliary heating (▷ page 124)
- Convenience (▷ page 196)
 - Key-dependent settings

i For safety reasons, it is not possible to reset all of the functions while the vehicle is in motion. For example, in the **Lighting** submenu, the **Daytime runn. lamps** function remains unchanged.





Resetting all settings



Settings menu

When the **Settings** message is displayed, you can reset all functions of the submenu to the factory settings.

Using the steering wheel buttons









- ▶ Press the  or  button repeatedly until the **Settings** menu appears in the display.
- ▶ Press and hold the  reset button for approximately 3 seconds. You will see a message in the display prompting you to press the  reset button again to confirm.
- ▶ Press the  reset button again. The functions in all submenus are reset to the factory settings.

- i** If you want to retain the settings, do not press the  reset button a second time. The **Settings** menu appears again after approximately 5 seconds.

Resetting the functions of a submenu

You can individually reset the functions of each submenu to the factory settings.

Using the steering wheel buttons

- ▶ Press the  or  button repeatedly until the **Settings** menu appears in the display.
- ▶ Press the  button to switch to the submenu selection.
- ▶ Press the  or  button to select a submenu.
- ▶ Press and hold the  reset button for approximately 3 seconds. You will see a message in the display prompting you to press the  reset button again to confirm.
- ▶ Press the  reset button again. All functions in the submenu are reset to the factory settings.

- i** If you want to retain the settings, do not press the  reset button a second time.









The **Settings** menu appears again after approximately 5 seconds.

Selecting submenus



You will see the collection of submenus. There are more submenus than can be displayed at the same time.

Using the steering wheel buttons









- ▶ Press the  or  button repeatedly until the **Settings** menu appears in the display.
- ▶ Press the  button to switch to the submenu selection.
- ▶ Press the  or  button to select a submenu. The submenu currently selected is highlighted.
- ▶ Press the  button to select the function within a submenu.
- ▶ Change the setting by pressing the  or  button. The changed setting is saved.

Instrument cluster submenu

Selecting the unit for temperature











Using the steering wheel buttons

- ▶ Press the  or  button repeatedly until the **Settings** menu appears in the display.
- ▶ Press the  button to switch to the sub-menu selection.
- ▶ Press the  or  button to select the **Inst. cluster** sub-menu.
- ▶ Press the  button to select the **Temperat.** function.
The selection marker is on the current setting.
- ▶ Press the  or  button to select the unit for all messages in the display: **°C** (degrees Celsius) or **°F** (degrees Fahrenheit).

Selecting the unit for the digital speedometer











Using the steering wheel buttons

- ▶ Press the  or  button repeatedly until the **Settings** menu appears in the display.
- ▶ Press the  button to switch to the sub-menu selection.
- ▶ Press the  or  button to select the **Inst. cluster** sub-menu.
- ▶ Press the  button to select the **Dig. speedo.** function.
The selection marker is on the current setting.
- ▶ Press the  or  button to select the unit for the digital speedometer: **km/h** or **mph**.

Selecting the unit for distance



Using the steering wheel buttons





- ▶ Press the  or  button repeatedly until the **Settings** menu appears in the display.
- ▶ Press the  button to switch to the sub-menu selection.
- ▶ Press the  or  button to select the **Inst. cluster** sub-menu.
- ▶ Press the  button to select the **Trip** function.
The selection marker is on the current setting.
- ▶ Press the  or  button to select the unit for all messages in the display: **km** (kilometers) or **miles**.



Selecting the language



The selected range of languages shown is just an example. The range of languages available is specific to each country.

Using the steering wheel buttons









- ▶ Press the  or  button repeatedly until the **Settings** menu appears in the display.
- ▶ Press the  button to switch to the sub-menu selection.
- ▶ Press the  or  button to select the **Inst. cluster** sub-menu.

- ▶ Press the  button to select the **Language** function.
The selection marker is on the current setting.
- ▶ Press the  or  button to set the language for all messages.

Selecting the display for the status bar











Using the steering wheel buttons

- ▶ Press the  or  button repeatedly until the **Settings** menu appears in the display.
- ▶ Press the  button to switch to the sub-menu selection.
- ▶ Press the  or  button to select the **Inst. cluster** sub-menu.
- ▶ Press the  button to select the **Select disp.** function.
The selection marker is on the current setting.
- ▶ Press the  or  button to select whether to display the outside temperature or the speed (digital speedometer).
The selected display is then shown permanently in the lower part of the display.

Selecting the unit for the tire pressure



Using the steering wheel buttons









- ▶ Press the  or  button repeatedly until the **Settings** menu appears in the display.
- ▶ Press the  button to switch to the sub-menu selection.
- ▶ Press the  or  button to select the **Inst. cluster** sub-menu.
- ▶ Press the  button to select the **Tire pres.** function.
The selection marker is on the current setting.
- ▶ Press the  or  button to select the unit for the tire pressure in the display: **bar** or **psi**.

Clock submenu

Setting the time











Using the steering wheel buttons

- ▶ Press the  or  button repeatedly until the **Settings** menu appears in the display.
- ▶ Press the  button to switch to the sub-menu selection.
- ▶ Press the  or  button to select the **Clock/Date** sub-menu.
- ▶ Press the  button to select the **Set clock Hours** or **Minutes** function.
- ▶ Press the  or  button to set the values.

Selecting the time format











Using the steering wheel buttons

- ▶ Press the  or  button repeatedly until the **Settings** menu appears in the display.
- ▶ Press the  button to switch to the sub-menu selection.
- ▶ Press the  or  button to select the **Clock/Date** sub-menu.
- ▶ Press the  button to select the **12/24 h** function. The selection marker is on the current setting.
- ▶ Press the  or  button to select the **12 h** or **24 h** clock format.

Lighting submenu

Activating/deactivating Highbeam Assist

Using the steering wheel buttons

- ▶ Press the  or  button repeatedly until the **Settings** menu appears in the display.
- ▶ Press the  button to switch to the sub-menu selection.
- ▶ Press the  or  button to select the **Lighting** submenu.
- ▶ Press the  button to select the **Highbeam Assist** function. The selection marker is on the current setting.
- ▶ Use the  or  button to switch Highbeam Assist **On** or **Off**.

i For safety reasons, it is not possible to reset the **Highbeam Assist** function to the factory settings during a journey. You will see the following message in the display:

Setting only possible at standstill.

For further information about Highbeam Assist, see (▷ page 97).









Switching the daytime running lamps on/off





If you switch the daytime running lamps function to **On**, the daytime running lamps will automatically light up when the engine is running.

For safety reasons, it is only possible to change this setting when the vehicle is stationary. The factory setting is **On** in countries in which daytime running lamp mode or daytime running lamps are mandatory.

Using the steering wheel buttons

- ▶ Press the  or  button repeatedly until the **Settings** menu appears in the display.
- ▶ Press the  button to switch to the sub-menu selection.
- ▶ Press the  or  button to select the **Lighting** submenu.
- ▶ Press the  button to select the **Daytime runn. lamps** function. The selection marker is on the current setting.
- ▶ Press the  or  button to switch the daytime running lamps **On** or **Off**.

i If you turn the light switch to  or , the corresponding lamp switches on. If you turn the light switch to **AUTO**, the daytime running lamps remain switched on.

i For safety reasons, it is not possible to reset the **Daytime runn. lamps** function to the factory setting while the vehicle is in

motion. You will see the following message in the display: **Setting only possible at standstill.**

Switching surround lighting on or off



Using the steering wheel buttons

- ▶ Press the or button repeatedly until the **Settings** menu appears in the display.
- ▶ Press the button to switch to the sub-menu selection.
- ▶ Press the or button to select the **Lighting** sub-menu.
- ▶ Press the button to select the **Loc. Lighting** function. The selection marker is on the current setting.
- ▶ Use the or button to switch the surround lighting **On** or **Off**.

If you switch the surround lighting to **On**, the following lamps light up in the dark after you have unlocked the vehicle using the key:

- the parking lamps
- the tail lamps
- the license plate lamps
- the fog lamps

The surround lighting automatically switches off after 40 seconds or if you:

- open the driver's door
- insert the key into the ignition lock
- lock the vehicle using the key

Setting the exterior lighting delayed switch-off



In the **Headlamps** sub-menu, you can set whether and for how long you wish the exterior lighting to remain on after closing the doors.

Using the steering wheel buttons

- ▶ Press the or button repeatedly until the **Settings** menu appears in the display.
- ▶ Press the button to switch to the sub-menu selection.
- ▶ Press the or button to select the **Lighting** sub-menu.
- ▶ Press the button to select the **Headlamps** function. The selection marker is on the current setting.
- ▶ Press the or button to select whether and for how long you wish the exterior lighting to remain on.

If you have set the delayed switch-off and switch off the engine, the following remain lit:

- the parking lamps
- the tail lamps
- the license plate lamps
- the fog lamps

i You can reactivate this function by opening a door within 10 minutes.

If, after switching off the engine, you do not open a door or you close an open door, the exterior lighting switches off after 60 seconds.

Vehicle submenu









Setting the radio station selection



With the **Search** function, you can set how the radio changes the station when you operate it with the steering wheel buttons (not with Audio 20).

The **Frequency** setting starts the station search. The **Memory** setting selects the next stored station.

Using the steering wheel buttons









- ▶ Press the  or  button repeatedly until the **Settings** menu appears in the display.
- ▶ Press the  button to switch to the submenu selection.
- ▶ Press  or  to select the **Vehicle** submenu.
- ▶ Press the  button to select the **Search** function.
The selection marker is on the current setting.
- ▶ Press the  or  button to select the station search mode.

Setting the windshield wiper sensitivity



You can use the **Wipe sensor** function to set the sensitivity of the rain/ light sensor.

Using the steering wheel buttons

- ▶ Press the  or  button repeatedly until the **Settings** menu appears in the display.
- ▶ Press the  button to switch to the submenu selection.
- ▶ Press  or  to select the **Vehicle** submenu.
- ▶ Press the  button to select the **Wipe sensor** function.
The selection marker is on the current setting.
- ▶ Press the  or  button to adjust the sensitivity of the rain/light sensor.

The levels are graded as follows:

- **Level 1:** high sensitivity – wiping begins even in light rain
- **Level 2:** moderate sensitivity
- **Level 3:** low sensitivity – wiping only begins in heavy rain





Convenience submenu





The **Key** function allows you to define whether settings for some submenus are stored with a key dependence.

This function pertains to the **Inst. cluster** (instrument cluster) menu, the **Lighting** menu and the **Vehicle** menu.

Using the steering wheel buttons

- ▶ Press the  or  button repeatedly until the **Settings** menu appears in the display.
- ▶ Press the  button to switch to the submenu selection.
- ▶ Press the  or  button to select the **Convenience** submenu.

- ▶ Press the  button to select the **Key** function.
The selection marker is on the current setting.
- ▶ Press the  or  button to activate or deactivate key dependency.

Trip computer menu

General notes

You can call up or reset statistical data for the vehicle in the **Trip computer** menu.

- i** When you call up the trip computer again, it displays the last function called up.
The units of the statistical information displayed are set permanently for each specific country, and are therefore independent of the units selected in the **Settings** menu.

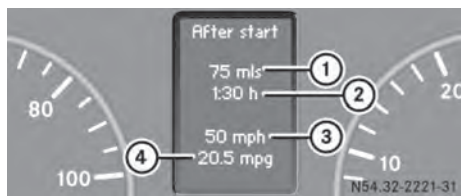

Trip computer "After start" or "After reset"





Example: "After start" trip computer

- ① Distance
- ② Time
- ③ Average speed
- ④ Average fuel consumption

Using the steering wheel buttons

- ▶ Press the  or  button to select **After start**.

Or

- ▶ Press the  or  button to select **After reset**.

The values in the **After start** submenu refer to the start of the journey. The values in

the **After reset** submenu are calculated from the last time the trip computer was reset.

The **After start** trip computer function is automatically reset if:

- the ignition has been switched off for more than four hours.
- 999 hours have been exceeded.
- 9,999 miles have been exceeded.



The **After reset** trip computer is automatically reset if the value exceeds 9,999 hours or 99,999 miles.

- i** If you turn the key to position **0** in the ignition lock or remove it, all the values are reset after approximately four hours.
The values will not be reset if you turn the key back to position **1** or **2** during this time.

Calling up the range

Using the steering wheel buttons

- ▶ Press the  or  button to select **After start**.





- ▶ Select **Range** using the  or  button.

The approximate distance which can be covered with the tank's current contents and your current style of driving is shown.

- i** If there is only a small amount of fuel left in the fuel tank, the  **Please refuel** message is shown instead of the range.

Resetting the trip computer

Using the steering wheel buttons

- ▶ Press the  or  button to select **After start**.
- ▶ Press the  or  button to select the function you would like to reset.
- ▶ Press and hold the  reset button until the values are reset to "0".

Telephone menu

Introduction



WARNING

If you operate information systems and communication equipment integrated in the vehicle while driving, you will be distracted from traffic conditions. You could also lose control of the vehicle. There is a risk of an accident.

Only operate the equipment when the traffic situation permits. If you are not sure that this is possible, park the vehicle paying attention to traffic conditions and operate the equipment when the vehicle is stationary.

You must observe the legal requirements for the country in which you are currently driving when operating a mobile phone in the vehicle. If it is permitted to operate a mobile phone while the vehicle is in motion, only operate it when road and traffic conditions permit.

If you have connected a mobile phone to the Sprinter hands-free system, you can operate it using the functions in the **TEL** menu.

- ▶ Switch on the mobile phone (see the separate operating instructions).
- ▶ Switch on the audio equipment (see the separate operating instructions).
- ▶ Establish a Bluetooth® connection between the mobile phone and the audio equipment (see the separate operating instructions).
- ▶ Press the  or  button on the steering wheel to select the **TEL** menu.
- ▶ When **Please enter PIN:** appears in the display, enter the PIN using the mobile phone or audio equipment. The mobile phone searches for a network. The display remains blank during this time. You will see the mobile phone operational readiness display once the mobile phone has found a network.

- i** You can obtain further information about suitable mobile phones and connecting

mobile phones via Bluetooth® at any qualified specialist workshop.

- i** If the mobile phone operational readiness symbol goes out, your vehicle is outside of the transmission and reception range.

Accepting a call

- ▶ Press the  button on the steering wheel to accept an incoming call. The display shows the call duration.





Rejecting or ending a call

- ▶ Press the  button on the steering wheel to reject or end a call. The caller then hears the engaged tone. The display shows the mobile phone operational readiness symbol again.

Dialing a number from the phone book



You can use the mobile phone to enter new telephone numbers into the phone book (see the separate operating instructions). If your mobile phone is able to receive calls, you can search for and dial a number from the phone book.

Using the steering wheel buttons



- ▶ Use the  or  buttons to select the **TEL** menu. The display shows the mobile phone operational readiness symbol.
- ▶ Press the  or  buttons to switch to the phone book. The on-board computer reads the phone book stored on the SIM card or in the mobile phone. This may take more than a minute. When the message is no longer displayed, reading has ended.

- ▶ Press the  or  button to select the desired name.

Or

- ▶ **To start rapid scrolling:** press and hold the  or  button longer than 1 second. Rapid scrolling stops when you release the button or reach the end of the list.







Using the steering wheel buttons

- ▶ **To start dialing:** press the  button. The on-board computer dials the corresponding phone number. When a connection is established, the name of the other person and/or the call duration appear in the display.
- ▶ **To exit the telephone book:** press the  button.

Redialing

The on-board computer saves the last names or numbers dialed in the redial memory.

Using the steering wheel buttons

- ▶ Use the  or  buttons to select the **TEL** menu. The display shows the mobile phone operational readiness symbol.
- ▶ Press the  button. The display shows the most recently dialed numbers or names in the redial memory.
- ▶ Press the  or  button to select the desired name or number.
- ▶ **To start dialing:** press the  button. The on-board computer dials the corresponding phone number. When a connection is established, the name of the other person and/or the call duration appear in the display.

Or

- ▶ **To exit the redial memory:** press the  button.

Display messages

Notes on display messages

Important safety notes

WARNING

No information will be displayed if either the instrument cluster or the display is inoperative.

As a result, you will not be able to see warning and indicator lamps or information about the driving conditions, such as speed or outside temperature. Driving characteristics may be impaired. Adjust your driving style and vehicle speed accordingly.

Contact a qualified specialist workshop immediately.

WARNING

If service work is not carried out correctly, the operating safety of your vehicle may be affected. This could cause you to lose control of your vehicle and cause an accident. Moreover, the safety systems may no longer be able to protect you or others as they are designed to do.

Always have service work carried out at a qualified specialist workshop.

- i** If you turn the key to position **2** in the ignition, a display check is performed. All warning/indicator lamps (except the turn signal indicator lamps) and the display are activated. Before starting the journey, check that the warning and indicator lamps are operating correctly.





Vehicles without steering wheel buttons

Warnings, malfunctions or additional information may also be shown in the display. The following tables show all the display messages. A warning tone sounds with certain display messages.

Vehicles with steering wheel buttons

The on-board computer shows warnings, malfunctions or additional information in the display. A warning tone sounds with certain display messages. Display messages of a high priority are shown in red.

Please respond in accordance with the display messages and follow the additional notes in this Operator's Manual.

You can hide low-priority display messages by pressing the , ,  or  button on the steering wheel or the  reset button.

You cannot hide display messages of the highest priority. These messages will continue to be shown in the display until their cause has been eliminated.

The on-board computer stores certain display messages in the message memory ([▷ page 200](#)).



The following shows all the messages that could appear in the display, arranged alphabetically.

Message memory

The on-board computer only records and shows malfunctions and warnings from certain systems. Therefore, make sure that your vehicle is safe to use. You could cause an accident by driving an unsafe vehicle.





The on-board computer stores certain display messages. In the **Message memory** menu, you can call up stored display messages.

Using the steering wheel buttons

- ▶ Press the  or  button repeatedly until the number of stored display mes-

sages, e.g. **2 messages**, appears in the display.





If no malfunctions have occurred, the **No messages** message appears.







- ▶ Scroll through the stored display messages with the  or  button.
- ▶ **To exit the message memory menu:** press the  or  button.







When you switch off the ignition, all display messages are deleted from the message memory.

Display messages on vehicles without steering wheel buttons

Display messages	Possible causes/consequences and ► Solutions
... LIM km/h	<p>The speed display flashes.</p> <p>The vehicle has exceeded the speed set for variable SPEEDTRONIC or the programmed maximum speed for permanent SPEEDTRONIC, e.g. on a steep downhill gradient (overrun mode).</p> <p>► Apply the brakes yourself as required.</p>
NO TPMS	<p>The NO message is displayed for 30 seconds. The TPMS message is also displayed after 30 seconds.</p> <p>The tire pressure monitor has malfunctioned.</p> <p>► Have the tire pressure monitor and the wheels checked at a qualified specialist workshop.</p>
NO TPMS	<p>The NO message is displayed for 30 seconds. The TPMS message is also displayed after 30 seconds.</p> <p>The tire pressure monitor is not receiving signals from one or more wheels because:</p> <ul style="list-style-type: none"> • a wheel has been replaced with the spare wheel without wheel electronics. • the maximum temperature on one of the wheel electronics units has been exceeded. • the wheel electronics are malfunctioning. <p>► Have wheels with suitable wheel electronics units installed at a qualified specialist workshop.</p>
-- TPMS	<p>The -- message is displayed for 30 seconds. The TPMS message is also displayed after 30 seconds.</p> <p>The pressure is insufficient in one or more tires, or the pressures of the individual tires differ significantly.</p> <p>► Check the tire pressure at the next opportunity and correct it if necessary (▷ page 293).</p>

Display messages	Possible causes/consequences and ► Solutions
	<p>flashes for 5 seconds, the  indicator lamp also flashes and then lights up constantly.</p> <p>Lane Keeping Assist is deactivated and temporarily inoperative.</p> <p>Possible causes are:</p> <ul style="list-style-type: none"> • There are no lane markings present. • The camera's functionality is impaired due to heavy rain, snow or fog. • The camera cannot recognize the road markings: <ul style="list-style-type: none"> - It is too dark. - The lane markings are worn or are covered, for example, by dirt or snow. • The windshield is dirty in the camera's field of vision. <p>► Stop the vehicle paying attention to road and traffic conditions.</p> <p>► Secure the vehicle to prevent it from rolling away (▷ page 151).</p> <p>► Clean the windshield (▷ page 269), particularly in the camera's field of vision.</p> <p>If the  indicator lamp goes out, Lane Keeping Assist is operational again.</p> <p>If the problem persists, visit a qualified specialist workshop.</p>
 dEF Chk	<p>In addition, the yellow  Check Engine indicator lamp and the yellow  DEF indicator lamp light up and a warning tone sounds.</p> <p>The DEF reducing agent is contaminated, diluted or is not compliant with ISO 22241.</p> <p>After the first message and under normal operating conditions, you can drive on for up to approximately 50 miles (80 km). Then a warning tone sequence sounds and the engine can only be started another 16 times.</p> <p>► Have the DEF tank cleaned and refilled at a qualified specialist workshop as soon as possible.</p>



Display messages	Possible causes/consequences and ► Solutions
 <p>dEF Chk</p>	<p>In addition, the yellow  DEF indicator lamp lights up and a warning tone sounds.</p> <p>The DEF supply has dropped below 1.5 US gal (5.5 l).</p> <p>After the message appears for the first time, and under normal driving conditions, the remaining DEF supply will last for approximately 1000 miles (1600 km).</p> <p>After that, the 0.8 US gal (3.0 l) reserve mark is reached. A warning tone sequence sounds and the engine can then only be started another 16 times.</p> <p>► add DEF supply (► page 149).</p> <p>The  DEF indicator lamp disappears after no more than 20 seconds after the vehicle has stopped or you have switched on the ignition or started the engine after refueling.</p>
 <p>StArtS RExx</p>	<p>In addition, the yellow  Check Engine indicator lamp and the yellow  DEF indicator lamp light up and a warning tone sounds. A warning tone sequence sounds.</p> <p>After the message appears for the first time, the engine can only be started another 16 times.</p> <p>The number of remaining engine starts XX (16 to 0) is shown in the message every time the engine is started. When the number of remaining engine starts is 0 the engine management prevents the vehicle being driven at a speed exceeding 5 mph (8 km/h). The Idle Mode message appears in the multifunction display:</p> <p>The DEF reducing agent is contaminated, diluted or is not compliant with ISO 22241.</p> <p>► Have the DEF tank cleaned and refilled at a qualified specialist workshop as soon as possible.</p> <p>The exhaust gas aftertreatment is malfunctioning or an emission relevant malfunction has occurred. This malfunction or defect can damage the exhaust gas aftertreatment.</p> <p>► Visit a qualified specialist workshop immediately.</p>







Display messages	Possible causes/consequences and ► Solutions
 <p>StArtS IdLE</p>	<p>In addition, the yellow  DEF indicator lamp lights up and a warning tone sequence sounds.</p> <p>The DEF supply has dropped below the 0.8 US gal (3.0 l) reserve mark.</p> <p>After the message appears for the first time, the remaining DEF supply will last for approximately 1000 miles (1600 km). The engine can then only be started another 16 times.</p> <p>The number of remaining engine starts XX (16 to 0) is shown in the message every time the engine is started. If the number displayed is 0, the yellow  Check Engine indicator lamp also lights up and you can only drive the vehicle at a maximum 5 mph (8 km/h).</p> <p>► Add at least 2.0 US gal (7.6 l) of DEF (► page 149).</p> <p>The  DEF indicator lamp disappears after no more than 20 seconds after the vehicle has stopped or you have switched on the ignition or started the engine after refueling.</p>
<p>Err</p>	<p>flashes for 5 seconds, the  indicator lamp also flashes and then goes out.</p> <p>Highbeam Assist is deactivated and temporarily not operational or Highbeam Assist is malfunctioning.</p> <p>Possible causes are:</p> <ul style="list-style-type: none"> • The camera's functionality is impaired due to heavy rain, snow or fog. • The windshield is dirty in the camera's field of vision. <p>► Stop the vehicle paying attention to road and traffic conditions.</p> <p>► Secure the vehicle to prevent it from rolling away (► page 151).</p> <p>► Clean the windshield (► page 269), particularly in the camera's field of vision.</p> <p>If the  indicator lamp goes out, Highbeam Assist is operational again.</p> <p>If the problem persists, visit a qualified specialist workshop.</p>







Display messages	Possible causes/consequences and ► Solutions
Blind_Err	flashes for 5 seconds, the yellow indicator lamps flash in the exterior mirrors and then lights up constantly. Blind Spot Assist is faulty. ► Visit a qualified specialist workshop.
Err	flashes for 5 seconds, the  indicator lamp also flashes and then lights up constantly. Collision Prevention Assist is malfunctioning. ► Visit a qualified specialist workshop.







Display messages on vehicles with steering wheel buttons

Safety systems











Display messages	Possible causes/consequences and ► Solutions
<p>ABS Visit workshop</p>	<p>ABS has been deactivated due to a malfunction. ESP[®], ASR and BAS, as well as cruise control, have also been deactivated as a result.</p> <p> WARNING</p> <p>The brake system continues to function normally, but without the functions listed above. The wheels could therefore lock if you brake hard, for example.</p> <p>This causes steerability and braking to be greatly impaired. The braking distance can increase in emergency braking situations. The driven wheels can spin when accelerating.</p> <p>If ESP[®] is not operational, ESP[®] will not stabilize the vehicle. There is an increased risk of skidding and accidents.</p> <ul style="list-style-type: none"> ► Drive on with care. ► Visit a qualified specialist workshop immediately.
<p>ABS Unavailable</p>	<p>ABS is temporarily unavailable or is deactivated due to undervoltage. ESP[®], ASR and BAS, as well as cruise control, are also unavailable as a result.</p> <p>The battery may not be being charged.</p> <p> WARNING</p> <p>The brake system continues to function normally, but without the functions listed above. The wheels could therefore lock if you brake hard, for example.</p> <p>This causes steerability and braking to be greatly impaired. The braking distance can increase in emergency braking situations. The driven wheels can spin when accelerating.</p> <p>If ESP[®] is not operational, ESP[®] will not stabilize the vehicle. There is an increased risk of skidding and accidents.</p> <ul style="list-style-type: none"> ► Drive for a short distance at a speed of more than 13 mph (20 km/h). If the display message disappears, the functions mentioned above are available again. <p>If the display message continues to be displayed:</p> <ul style="list-style-type: none"> ► Drive on with care. ► Visit a qualified specialist workshop immediately.

Display messages	Possible causes/consequences and ► Solutions
 <p>Visit workshop</p>	<p>ASR has been deactivated due to a malfunction. The engine power output may be reduced.</p> <p> WARNING</p> <p>The driven wheels can spin when accelerating. There is an increased risk of skidding and accidents.</p> <ul style="list-style-type: none"> ► Drive on with care. ► Visit a qualified specialist workshop immediately.
 <p>Visit workshop</p>	<p>BAS has been deactivated due to a malfunction.</p> <p> WARNING</p> <p>The brake system continues to function normally, but without electronic support. The braking distance can increase in emergency braking situations. There is a risk of an accident.</p> <ul style="list-style-type: none"> ► Drive on with care. ► Visit a qualified specialist workshop immediately.
 <p>Unavailable</p>	<p>ASR and BAS have been deactivated due to undervoltage. The battery may not be being charged.</p> <p> WARNING</p> <p>The brake system continues to function normally, but without the functions listed above. The wheels could therefore lock if you brake hard, for example. The braking distance can increase in emergency braking situations. The driven wheels can spin when accelerating. There is an increased risk of skidding and accidents.</p> <ul style="list-style-type: none"> ► Drive on with care. ► Visit a qualified specialist workshop immediately.
 <p>Brake wear Visit workshop</p>	<p>The brake pads/linings have reached their wear limit.</p> <ul style="list-style-type: none"> ► Have the brake pads/linings replaced as soon as possible at a qualified specialist workshop.













Display messages	Possible causes/consequences and ► Solutions
 <p>Brake fluid Visit workshop</p>	<p>There is insufficient brake fluid in the fluid reservoir.</p> <p> WARNING</p> <p>Braking performance can be impaired. There is a risk of an accident.</p> <ul style="list-style-type: none"> ► Stop the vehicle as soon as possible, paying attention to road and traffic conditions. ► Check the brake fluid level in the brake fluid reservoir (► page 256). <p>If the brake fluid is below the MIN mark:</p> <ul style="list-style-type: none"> ► Do not continue driving under any circumstances. ► Do not add brake fluid. This does not solve the problem. ► Consult a qualified specialist workshop. <p>If the brake fluid is above the MIN mark:</p> <ul style="list-style-type: none"> ► Drive on with care. ► Visit a qualified specialist workshop immediately.
 <p>Brake force distribution</p>	<p>EBD has been deactivated due to undervoltage. The battery may not be being charged.</p> <p> WARNING</p> <p>The rear wheels could lock when you apply the brakes. The braking distance can increase in emergency braking situations. There is an increased risk of skidding and accidents.</p> <ul style="list-style-type: none"> ► Stop the vehicle as soon as possible, paying attention to road and traffic conditions. ► Do not drive on. ► Consult a qualified specialist workshop.
 <p>Brake force distribution Visit workshop</p>	<p>EBD has been deactivated due to a malfunction.</p> <p> WARNING</p> <p>The rear wheels could lock when you apply the brakes. The braking distance can increase in emergency braking situations. There is an increased risk of skidding and accidents.</p> <ul style="list-style-type: none"> ► Stop the vehicle as soon as possible, paying attention to road and traffic conditions. ► Do not drive on. ► Consult a qualified specialist workshop.

Display messages	Possible causes/consequences and ► Solutions
ESP Visit workshop	ESP® has been deactivated due to a malfunction. As a result, cruise control has also been deactivated. Engine power output may be reduced.  WARNING If ESP® is not operational, ESP® will not stabilize the vehicle. There is an increased risk of skidding and accidents. ► Drive on with care. ► Visit a qualified specialist workshop immediately.
ESP Unavailable	ESP® has been deactivated due to undervoltage. As a result, cruise control has also been deactivated. The battery may not be being charged.  WARNING If ESP® is not operational, ESP® will not stabilize the vehicle. There is an increased risk of skidding and accidents. ► Drive on with care. ► Consult a qualified specialized workshop as soon as possible.
 Parking brake Release brake	Additionally, a warning tone sounds. You are driving with the parking brake applied. ► Release the parking brake (► page 152).
 Seatbelt sys. Visit workshop	The belt system has malfunctioned.  WARNING In the event of an accident or a rapid deceleration, the seat belts either cannot protect you as intended. There is a risk of injury. ► Consult a qualified specialized workshop as soon as possible.
SRS Restraint system Visit workshop	The restraint systems have malfunctioned.  WARNING If the restraint system is malfunctioning, individual systems could be triggered inadvertently or might not be triggered at all in the event of an accident. There is an increased risk of injury and accidents. ► Drive on with care. ► Visit a qualified specialist workshop immediately.



Lights

Display messages	Possible causes/consequences and ► Solutions
 Low beam left	The left-hand low beam is faulty ³ . ► Halogen headlamps: replace the bulb as soon as possible (▷ page 101). ► Bi-Xenon headlamps: consult a qualified specialist workshop as soon as possible.
 Low beam right	The right-hand low-beam headlamp is faulty ³ . ► Halogen headlamps: replace the bulb as soon as possible (▷ page 101). ► Bi-Xenon headlamps: consult a qualified specialist workshop as soon as possible.
 Cornering lt. left	The left-hand cornering light is faulty ³ . ► Replace the bulb as soon as possible (▷ page 101).
 Cornering lt. right	The right-hand cornering light is faulty ³ . ► Replace the bulb as soon as possible (▷ page 101).
 Lights on automatic. Remove key	The automatic headlamp feature is active: the light switch is in the AUTO position and you have forgotten to remove the key. ► Remove the key from the ignition lock.
 Turn signal left	The left-hand turn signal is faulty. ► Change the bulb as soon as possible in the front (▷ page 102) or rear (▷ page 103) indicator lamp.
 Turn signal right	The right-hand turn signal is faulty. ► Change the bulb as soon as possible in the front (▷ page 102) or rear (▷ page 103) indicator lamp.
 Brake lamp left	The left brake lamp is faulty ³ . ► Replace the bulb as soon as possible (▷ page 103).
 Brake lamp right	The right brake lamp is faulty ³ . ► Replace the bulb as soon as possible (▷ page 103).
 Third brake lamp	The third brake lamp is faulty ³ . This display message will only appear if all LEDs have failed. ► Consult a qualified specialized workshop as soon as possible.

³ Depending on the equipment, the bulb-failure indicator may not be featured for any lamps other than the turn signals.

Display messages	Possible causes/consequences and ► Solutions
 High beam left	The left high-beam headlamp is faulty ³ . ► Replace the bulb as soon as possible (▷ page 101).
 High beam right	The right high-beam headlamp is faulty ³ . ► Replace the bulb as soon as possible (▷ page 101).
 License plate lamp	A license plate lamp is faulty ³ . ► Replace the bulb as soon as possible (▷ page 104).
 Switch off lights	You have forgotten to switch off the lights when leaving the vehicle. ► Turn the light switch to  .
 Foglamp front left	The left-hand front fog lamp is faulty. ³ ► Have the bulb replaced as soon as possible at a qualified specialist workshop.
 Foglamp front right	The right-hand front fog lamp is faulty ³ . ► Have the bulb replaced as soon as possible at a qualified specialist workshop.
 Rear foglamp	The rear fog lamp is faulty ³ . ► Replace the bulb as soon as possible (▷ page 103).
 Parking lamp front left	The front left parking lamp/standing lamp is faulty ³ . ► Replace the bulb as soon as possible (▷ page 101).
 Parking lamp front right	The front right parking lamp/standing lamp is faulty ³ . ► Replace the bulb as soon as possible (▷ page 101).
 Reverse lamp	A reversing lamp is faulty ³ . ► Replace the bulb as soon as possible (▷ page 103).
 Tail lamp left	The left-hand tail lamp is faulty. ³ ► Replace the bulb as soon as possible (▷ page 103).







³ Depending on the equipment, the bulb-failure indicator may not be featured for any lamps other than the turn signals.







Display messages	Possible causes/consequences and ► Solutions
 Tail lamp right	The right-hand tail lamp is faulty. ³ ► Replace the bulb as soon as possible (▷ page 103).
 Perim. lamps	A perimeter lamp is faulty ³ . ► Replace the bulb as soon as possible (▷ page 105).
Highbeam Assist inoperative	Highbeam Assist is faulty. ► Visit a qualified specialist workshop.
Highbeam Assist temporarily unavailable	Highbeam Assist is deactivated and temporarily inoperative. Possible causes are: <ul style="list-style-type: none"> • The camera's functionality is impaired due to heavy rain, snow or fog. • The windshield is dirty in the camera's field of vision. ► Stop the vehicle paying attention to road and traffic conditions. ► Secure the vehicle to prevent it from rolling away (▷ page 151). ► Clean the windshield (▷ page 269), particularly in the camera's field of vision. If the malfunction has been resolved, the Highbeam Assist available again message appears.



³ Depending on the equipment, the bulb-failure indicator may not be featured for any lamps other than the turn signals.

Engine

Display messages	Possible causes/consequences and ► Solutions
<p>Exhaust Filter: Drive at high engine speed. See Oper. Manual</p>	<p>The automatic regeneration of the diesel particle filter is not sufficient or has malfunctioned.</p> <p>► Drive at an engine speed of above 2000 rpm until the display message disappears.</p> <p>If the display message does not go out after approximately 20 minutes, have the malfunction rectified immediately at a qualified specialist workshop.</p>
<p>Check Diesel Exhaust Fluid See Operator's Manual</p>	<p>The Diesel Exhaust Fluid (DEF) supply has dropped below 1.5 US gal (5.5 l).</p> <p>After the message appears for the first time, and under normal driving conditions, the remaining DEF supply will last for approximately 1000 miles (1600 km).</p> <p>After that, the 0.8 US gal (3.0 l) reserve mark is reached. A warning tone sequence sounds and the engine can then only be started another 16 times.</p> <p>► Add DEF supply (► page 149).</p> <p>After topping up, the system check takes approximately 20 seconds. The display message then disappears.</p>
<p>Check Diesel Exhaust Fluid See Operator's Manual</p>	<p>If the yellow  Check Engine indicator lamp lights up as well, the DEF reducing agent is contaminated, diluted or not compliant with ISO 22241.</p> <p>After the first message and under normal operating conditions, you can drive on for up to approximately 50 miles (80 km). Then a warning tone sequence sounds and the engine can only be started another 16 times.</p> <p>Have the DEF tank cleaned and refilled at a qualified specialist workshop as soon as possible.</p>



Display messages	Possible causes/consequences and ► Solutions
 <p>XX starts remaining</p>	<p>The Diesel Exhaust Fluid (DEF) supply has dropped below the 0.8 US gal (3.0 l) reserve mark.</p> <p>After the message appears for the first time, the remaining DEF supply will last for approximately 1000 miles (1600 km). The engine can then only be started another 16 times.</p> <p>The number of remaining engine starts XX (16 to 0) is shown in the message every time the engine is started. If the number displayed is 0, the yellow  Check Engine indicator lamp also lights up and you can only drive the vehicle at a maximum 5 mph (8 km/h).</p> <p>► Add at least 2.0 US gal (7.6 l) of DEF (► page 149). The display message disappears no more than 20 seconds after the vehicle has stopped or you have switched on the ignition or started the engine after refueling.</p>
 <p>Idle Mode</p>	<p>In addition, the yellow  Check Engine indicator lamp lights up.</p> <p>The vehicle cannot be driven at a speed exceeding 5 mph (8 km/h).</p> <p>The DEF reducing agent is contaminated, diluted or is not compliant with ISO 22241.</p> <p>► Have the DEF tank cleaned and refilled at a qualified specialist workshop immediately.</p> <p>The exhaust gas aftertreatment is malfunctioning or an emission relevant malfunction has occurred. This malfunction or defect can damage the exhaust gas aftertreatment.</p> <p>► Visit a qualified specialist workshop immediately.</p>
 <p>Coolant Stop, turn engine off</p>	<p>The coolant temperature is too high.</p> <p>► Stop the vehicle as soon as possible, paying attention to road and traffic conditions.</p> <p>► Consult a qualified specialist workshop.</p>
 <p>Coolant Stop, turn engine off</p>	<p>The coolant temperature is too high.</p> <p>If the vehicle is stopped after being subjected to extreme loads, the coolant warning lamp may come on when the ignition is switched on or the engine is restarted. Such loads can be, for example, driving in mountainous terrain or driving with a trailer.</p> <p>► Run the engine for approximately 1 minute at idling speed.</p> <p>► Consult a qualified specialist workshop if the display message continues to be shown.</p>

Display messages	Possible causes/consequences and ► Solutions
 <p>Coolant Check level</p>	<p>The coolant level is too low.</p> <p>Never run the engine if the coolant level is too low. The engine could overheat and be damaged.</p> <ul style="list-style-type: none"> ► Stop the vehicle as soon as possible, paying attention to road and traffic conditions. ► Switch off the engine and let it cool down. ► Add coolant and be sure to observe the warning notes (> page 329). ► If you need to add coolant frequently, have the engine cooling system checked at a qualified specialist workshop.
 <p>Reserve fuel Drive to a filling stat.</p>	<p>The fuel level has fallen into the reserve range.</p> <ul style="list-style-type: none"> ► Refuel at the nearest gas station (> page 148).
 <p>Water in fuel Visit workshop</p>	<p>The water that has collected in the water separator has reached the maximum level.</p> <ul style="list-style-type: none"> ► Drain the water separator (> page 257).
 <p>Engine oil Add 1.0 quart(Canada: 1.0 liter)</p>	<p>The oil level is too low.</p> <ul style="list-style-type: none"> ► Check the oil level the next time you refuel (> page 252), and add oil.
 <p>Engine oil level Not when eng. running</p>	<p>You want to check the oil level even though the engine is running.</p> <ul style="list-style-type: none"> ► Switch off the engine. ► Check the oil level (> page 252).
 <p>Engine oil level Reduce oil level</p>	<p>You have added too much engine oil. There is a risk of damaging the engine or catalytic converter.</p> <ul style="list-style-type: none"> ► Check the oil level. ► If the oil level is too high: have the engine oil extracted at the next qualified specialist workshop. ► If the oil level is correct: have the malfunction rectified at the next qualified specialist workshop.

Display messages	Possible causes/consequences and ► Solutions
 <p>Engine oil level Stop, turn engine off</p>	<p>There is not enough or no oil in the engine. There is a danger of engine damage.</p> <ul style="list-style-type: none"> ► Stop the vehicle as soon as possible, paying attention to road and traffic conditions. ► Check the oil level with the oil dipstick (► page 253). ► If the engine oil level is correct: have the malfunction rectified immediately at a qualified specialist workshop. ► If the engine oil level is too low: have the vehicle towed to a qualified specialist workshop.
 <p>Oil sensor Visit workshop</p>	<p>There is a malfunction in the engine oil level display.</p> <ul style="list-style-type: none"> ► Have the vehicle checked immediately at a qualified specialist workshop.



Driving systems

Display messages	Possible causes/consequences and ► Solutions
<p>Limit ... km/h</p>	<p>The speed display flashes.</p> <p>The vehicle has exceeded the speed set for variable SPEEDTRONIC, e.g. on a steep downhill gradient (overrun mode).</p> <ul style="list-style-type: none"> ► Apply the brakes yourself as required.
<p>Cruise control Visit workshop</p>	<p>Cruise control has been deactivated due to a malfunction.</p> <ul style="list-style-type: none"> ► Have cruise control checked at a qualified specialist workshop.



Display messages	Possible causes/consequences and ► Solutions
Lane Keep. Assist temporarily unavailable	<p>and the  indicator lamp lights up. Lane Keeping Assist is deactivated and temporarily inoperative. Possible causes are:</p> <ul style="list-style-type: none"> • There are no lane markings present. • The camera's functionality is impaired due to heavy rain, snow or fog. • The camera cannot recognize the road markings: <ul style="list-style-type: none"> - It is too dark. - The lane markings are worn or are covered, for example, by dirt or snow. • The windshield is dirty in the camera's field of vision. <p>► Stop the vehicle paying attention to road and traffic conditions. ► Secure the vehicle to prevent it from rolling away (▷ page 151). ► Clean the windshield (▷ page 269), particularly in the camera's field of vision.</p> <p>If the  indicator lamp goes out, Lane Keeping Assist is operational again.</p>
Lane Keep. Assist inoperative	<p>Lane Keeping Assist is faulty.</p> <p>► Have Lane Keeping Assist checked at a qualified specialist workshop.</p>
Blind Spot Assist inoperative	<p>Blind Spot Assist is faulty.</p> <p>► Have Blind Spot Assist checked at a qualified specialist workshop.</p>
Collision Prevention Assist inoperative	<p>Collision Prevention Assist is faulty.</p> <p>► Have Collision Prevention Assist checked at a qualified specialist workshop.</p> <p>Recognition by the radar sensor system can be impaired in the case of:</p> <ul style="list-style-type: none"> • dirt on the sensors or anything else covering the sensors • it is snowing or raining heavily • there is interference from other radar sources • there are strong radar reflections, for example in parking garages • a narrow vehicle is traveling in front, e.g. a motorbike • a vehicle is traveling in front on a different line <p>► Clean the radar sensor system area.</p>





Tires

Display messages	Possible causes/consequences and ► Solutions
Tire pres. Adjust pres. 	The pressure is insufficient in one or more tires, or the pressures of the individual tires differ significantly. ► Check the tire pressure at the next opportunity and correct it if necessary (► page 293).
Tire pres. monitor inoperative	The tire pressure monitor has malfunctioned. ► Have the tire pressure monitor and the wheels checked at a qualified specialist workshop.
Tire pres. monitor currently unavailable	The tire pressure monitor function is temporarily unavailable due to radio interference or undervoltage. ► Once the causes have been remedied, the tire pressure monitor is automatically activated.
Tire pres.- monitor inoperative No wheel sensors	The tire pressure monitor is not receiving signals from one or more wheels because: <ul style="list-style-type: none"> • a wheel has been replaced with the spare wheel without wheel electronics. • the maximum temperature on one of the wheel electronics units has been exceeded. • the wheel electronics are malfunctioning. ► Have the tire pressure monitor and the wheels checked at a qualified specialist workshop.

Display messages	Possible causes/consequences and ► Solutions
<p>Check tire(s)</p> 	<p>The pressure of one or more tires has dropped significantly. If the tire pressure monitor has detected the affected wheel, the wheel position is also displayed.</p> <ul style="list-style-type: none"> ► Stop the vehicle as soon as possible, paying attention to road and traffic conditions. ► Check the tires. ► Repair or change the wheel if necessary (▷ page 307). ► Check the tire pressure and correct it if necessary (▷ page 293). <p>The display message disappears automatically after driving for a few minutes with the corrected tire pressure.</p>
<p>Warning Tire defect</p> 	<p>One or more tires is losing air rapidly. If the tire pressure monitor has detected the affected wheel, the wheel position is also displayed.</p> <ul style="list-style-type: none"> ► Stop the vehicle without making any sudden steering or braking maneuvers, paying attention to the traffic conditions as you do so. ► Repair or change the wheel (▷ page 307).

Vehicle









Display messages	Possible causes/consequences and ► Solutions
 <p>Battery/Alternator Visit workshop</p>	<p>The battery is not being charged. Possible causes are a defective alternator or a torn poly-V-belt.</p> <ul style="list-style-type: none"> ► Stop the vehicle as soon as possible, paying attention to road and traffic conditions. ► Check the poly-V-belt. ► If the poly-V-belt is torn: do not continue driving. Consult a qualified specialist workshop. ► If the poly-V-belt is not damaged: have the vehicle checked as soon as possible by a qualified specialist workshop.
 <p>Electrical Step</p>	<p>The electrical step has retracted or extended only partially or not at all.</p> <ul style="list-style-type: none"> ► Make sure there is sufficient free space for the electrical step. ► Open or close the sliding door again. ► If the electrical step still does not extend or retract fully, push the step in manually (▷ page 74). Before stepping out, remind the passengers that the step is missing.







Display messages	Possible causes/consequences and ► Solutions
 Hood open	You are already driving at walking pace, even though the hood is not closed. ► Close the hood.
 Please enter PIN:	You have not yet entered your PIN in the mobile phone. ► Enter the PIN for the SIM card.
 Doors open	You are already driving at walking pace, even though not all the doors are closed. ► Close the doors.
 Check wash. fluid level	The washer fluid level is too low. ► Add washer fluid (► page 257).





Key





Display messages	Possible causes/consequences and ► Solutions
 Replace key Visit workshop	The key is no longer working. ► Visit a qualified specialist workshop.







Indicator and warning lamps in the instrument cluster





Problem	Possible causes/consequences and ► Solutions
 The yellow ASR/ESP [®] warning lamp flashes while the vehicle is in motion.	 WARNING ESP [®] or ASR is intervening because at least one of the wheels has reached its tire grip limit. Cruise control is deactivated for the duration of the intervention. ► Adapt your driving style to suit the road and traffic conditions. Do not use too much throttle. ► Drive slowly.
 The yellow ASR/ESP [®] warning lamp is lit while the engine is running.	ASR is deactivated.  WARNING The driven wheels can spin when accelerating. There is an increased risk of skidding and accidents. ► Activate ASR again. Exceptions (► page 60).
    <p>The yellow ESP[®], ABS and ASR/BAS indicator lamps and the red brake system indicator lamp are lit while the engine is running.</p>	EBD is malfunctioning or deactivated due to undervoltage or malfunction. The battery may not be being charged.  WARNING The rear wheels could lock sooner than expected when you apply the brakes. The braking distance can increase in emergency braking situations. There is an increased risk of skidding and accidents. ► Vehicles with steering wheel buttons: also observe the messages in the display (► page 199). ► Stop the vehicle as soon as possible, paying attention to road and traffic conditions. ► Do not drive on. ► Consult a qualified specialist workshop.







Problem	Possible causes/consequences and ► Solutions
 The red brake system indicator lamp is lit while the engine is running.	<p>There is insufficient brake fluid in the expansion tank.</p> <p> WARNING</p> <p>Braking performance can be impaired. There is a risk of an accident.</p> <ul style="list-style-type: none"> ► Vehicles with steering wheel buttons: also observe the messages in the display (► page 199). ► Stop the vehicle as soon as possible, paying attention to road and traffic conditions. ► Check the brake fluid level in the expansion tank (► page 256). ► If the brake fluid is below the MIN mark: do not drive on! ► Do not add brake fluid. This does not solve the problem. ► Consult a qualified specialist workshop.
 When towing a trailer: the red brake system indicator lamp is lit while the engine is running. Additionally, a warning tone sounds.	<p> WARNING</p> <p>The brake force booster in the trailer is faulty. The driving and braking characteristics of your vehicle could change. There is a risk of the trailer overbraking and of you losing control over the truck/trailer combination. There is a risk of an accident.</p> <ul style="list-style-type: none"> ► Vehicles with steering wheel buttons: also observe the messages in the display (► page 199). ► Stop the vehicle as soon as possible, paying attention to road and traffic conditions. ► Do not drive on. ► Consult a qualified specialist workshop.
 The yellow ASR/BAS indicator lamp is lit while the engine is running.	<p>ASR has been deactivated due to a malfunction. The engine power output may be reduced.</p> <p> WARNING</p> <p>The driven wheels can spin when accelerating. There is an increased risk of skidding and accidents.</p> <ul style="list-style-type: none"> ► Drive on with care. ► Consult a qualified specialist workshop as soon as possible.



Problem	Possible causes/consequences and ► Solutions
 The yellow ASR/BAS indicator lamp is lit while the engine is running.	<p>BAS has been deactivated due to a malfunction.</p> <p> WARNING</p> <p>The brake system continues to function normally, but without electronic support.</p> <p>The braking distance can increase in emergency braking situations.</p> <p>There is a risk of an accident.</p> <ul style="list-style-type: none"> ► Drive on with care. ► Visit a qualified specialist workshop immediately.
 The yellow ASR/BAS indicator lamp is lit while the engine is running.	<p>ASR and BAS have been deactivated due to undervoltage.</p> <p>The battery may not be being charged.</p> <p> WARNING</p> <p>The brake system is still available with the normal braking effect.</p> <p>The driven wheels can spin when accelerating.</p> <p>The braking distance can increase in emergency braking situations.</p> <p>There is an increased risk of skidding and accidents.</p> <ul style="list-style-type: none"> ► Drive on with care. ► Visit a qualified specialist workshop immediately.





Problem	Possible causes/consequences and ► Solutions
 The yellow ABS indicator lamp is lit while the engine is running.	<p>ABS is deactivated due to a malfunction or is temporarily unavailable. ESP[®], ASR and BAS, as well as cruise control, are also unavailable as a result.</p> <p>Self-diagnosis may not be complete, or the battery may not be charging.</p> <p> WARNING</p> <p>The brake system continues to function normally, but without the functions listed above. The wheels could therefore lock, e.g. if the brakes are applied with maximum force.</p> <p>This causes steerability and braking to be greatly impaired.</p> <p>The braking distance can increase in emergency braking situations.</p> <p>The driven wheels can spin when accelerating.</p> <p>If ESP[®] is not operational, ESP[®] will not stabilize the vehicle.</p> <p>There is an increased risk of skidding and accidents.</p> <p>► Drive a short distance at a speed above 13 mph (20 km/h). The functions mentioned above are available again when the indicator lamp goes out.</p> <p>If the indicator lamp does not go out:</p> <ul style="list-style-type: none"> ► Drive on with care. ► Visit a qualified specialist workshop immediately.
 The yellow DEF indicator lamp is lit while the engine is running.	<p>The exhaust gas aftertreatment is malfunctioning or the current Diesel Exhaust Fluid (DEF) supply is limiting the vehicle range.</p> <p>► Observe the messages in the display.</p>
 The yellow ESP [®] indicator lamp is lit while the engine is running.	<p>ESP[®] is deactivated due to undervoltage or a malfunction. As a result, cruise control has also been deactivated.</p> <p>Engine power output may be reduced.</p> <p>The battery may not be being charged.</p> <p> WARNING</p> <p>If ESP[®] is not operational, ESP[®] will not stabilize the vehicle.</p> <p>There is an increased risk of skidding and accidents.</p> <ul style="list-style-type: none"> ► Vehicles with steering wheel buttons: also observe the messages in the display (> page 199). ► Drive on with care. ► Visit a qualified specialist workshop immediately.





Problem	Possible causes/consequences and ► Solutions
 The red warning lamp does not go out approximately 4 seconds after the ignition is switched on, or it lights up again.	<p>The restraint systems have malfunctioned.</p> <p> WARNING</p> <p>If the restraint systems are malfunctioning, individual systems could be triggered inadvertently or might not be triggered at all in the event of an accident.</p> <p>There is an increased risk of injury and accidents.</p> <ul style="list-style-type: none"> ► Drive on with care. ► Visit a qualified specialist workshop immediately.
 The red battery indicator lamp is lit while the engine is running.	<p>The battery is not being charged. Possible causes are a defective alternator or a torn poly-V-belt.</p> <ul style="list-style-type: none"> ► Stop the vehicle as soon as possible, paying attention to road and traffic conditions. ► Check the poly-V-belt. ► If the poly-V-belt is torn: do not continue driving. Consult the nearest qualified specialist workshop. ► If the poly-V-belt is not damaged: have the vehicle checked as soon as possible by a qualified specialist workshop.
 The red battery indicator lamp is lit while the engine is running.	<p>The battery is faulty.</p> <ul style="list-style-type: none"> ► Stop the vehicle as soon as possible, paying attention to road and traffic conditions. ► Do not continue driving under any circumstances. ► Consult a qualified specialist workshop.
 The yellow brake pad wear indicator lamp is lit after the engine is started or while the vehicle is in motion.	<p>The brake pads/linings have reached their wear limit.</p> <p> WARNING</p> <p>Braking performance can be impaired.</p> <p>There is a risk of an accident.</p> <ul style="list-style-type: none"> ► Have the brake pads/linings replaced as soon as possible at a qualified specialist workshop.
 The yellow engine oil level warning lamp is lit after the engine is started or while the vehicle is in motion.	<p>The oil level has dropped to the minimum level.</p> <ul style="list-style-type: none"> ► Check the engine for oil loss. ► If oil loss is detected: consult a qualified specialist workshop immediately. ► If no oil loss is detected: check the oil level and add engine oil (► page 253).

Problem	Possible causes/consequences and ► Solutions
 <p>The yellow engine oil level warning lamp flashes and the warning buzzer sounds after the engine is started or while the vehicle is in motion.</p>	<p>On vehicles with a diesel engine, the oil level display additionally appears in the display, e.g. - 2.0 qts (Canada: - 2.0 ltr). There is not enough or no oil in the engine. There is a danger of engine damage.</p> <ul style="list-style-type: none"> ► Stop the vehicle as soon as possible, paying attention to road and traffic conditions. ► Check the oil level with the oil dipstick (> page 253). ► If the engine oil level is correct: have the malfunction rectified immediately at a qualified specialist workshop. ► If the engine oil level is too low: have the vehicle towed to a qualified specialist workshop.
 <p>The yellow engine oil level warning lamp lights up and the warning buzzer sounds after the engine is started or while the vehicle is in motion.</p>	<p>The engine oil level is above the maximum level. There is a risk of damaging the engine or catalytic converter.</p> <ul style="list-style-type: none"> ► Check the oil level. ► If the oil level is too high: have the engine oil extracted as soon as possible at a qualified specialist workshop. ► If the oil level is correct: have the malfunction rectified as soon as possible at a qualified specialist workshop.
 <p>On vehicles with a diesel engine, the yellow engine oil level warning lamp lights up repeatedly during the journey.</p>	<p>There is a malfunction in the engine oil level display.</p> <ul style="list-style-type: none"> ► Have the vehicle checked immediately at a qualified specialist workshop.
 <p>The yellow coolant level warning lamp lights up while the engine is running.</p>	<p>The coolant level is too low. Never run the engine if the coolant level is too low. The engine could overheat and be damaged.</p> <ul style="list-style-type: none"> ► Stop the vehicle as soon as possible, paying attention to road and traffic conditions. ► Switch off the engine and let it cool down. ► Add coolant and be sure to observe the warning notes (> page 255). ► If you need to add coolant frequently, have the engine cooling system checked at a qualified specialist workshop.

Problem	Possible causes/consequences and ► Solutions
 The red coolant warning lamp is lit while the engine is running.	<p>The coolant temperature is too high.</p> <ul style="list-style-type: none"> ► Stop the vehicle as soon as possible, paying attention to road and traffic conditions. ► Consult a qualified specialist workshop.
 The red coolant warning lamp is lit while the engine is running.	<p>The coolant temperature is too high.</p> <p>If the vehicle is stopped after being subjected to extreme loads, the coolant warning lamp may come on when the ignition is switched on or the engine is restarted. Such loads can be, for example, driving in mountainous terrain or driving with a trailer.</p> <ul style="list-style-type: none"> ► Run the engine for approximately 1 minute at idling speed. ► Consult a qualified specialist workshop if the display message continues to be shown.
  The yellow reserve fuel warning lamp is on. At the same time, 0, appears in the fuel tank content display while the engine is running, although there is fuel in the fuel tank.	<p>The fuel filler cap is not closed.</p> <ul style="list-style-type: none"> ► Close the fuel filler cap. You will hear a click when the fuel filler cap is closed fully. ► If the malfunction continues to be displayed, have it rectified immediately at a qualified specialist workshop.
 The yellow engine diagnostic indicator lamp is lit up or flashes while the engine is running.	<p>You have used up all fuel in the tank.</p> <p>The engine is running in emergency mode.</p> <ul style="list-style-type: none"> ► Refuel at the nearest gas station (► page 148). ► Bleed the fuel system (► page 143). ► Start the engine three to four times in succession after refueling. Emergency running mode will be canceled. The vehicle does not need to be checked.
 The yellow engine diagnostic indicator lamp is lit up or flashes while the engine is running.	<p>The injection control is malfunctioning.</p> <p>The engine is running in emergency mode.</p> <p>Engine power output may be reduced.</p> <ul style="list-style-type: none"> ► Have the vehicle checked at a qualified specialist workshop as soon as possible. <p>In some states it is legally prescribed that after the check engine indicator lamp lights up you must contact a qualified specialist workshop immediately. Observe the legal requirements.</p>

Problem	Possible causes/consequences and ► Solutions
 The yellow Check Engine indicator lamp is lit while the engine is running.	<p>The exhaust gas aftertreatment is malfunctioning or an emission relevant malfunction has occurred. This malfunction or defect can damage the exhaust gas aftertreatment.</p> <p>After the first message and under normal operating conditions, you can drive on for up to approximately 500 mi (800 km). Then a warning tone sequence sounds and the engine can only be started another 16 times.</p> <ul style="list-style-type: none"> ► Observe the messages in the display. ► Have the exhaust gas aftertreatment checked immediately at a qualified specialist workshop. <p>In some states it is legally prescribed that after the check engine indicator lamp lights up you must contact a qualified specialist workshop immediately. Observe the legal requirements.</p>
 If you turn the key to position 2 in the ignition lock, the yellow preglow indicator lamp remains lit for approximately 1 minute. Or the yellow preglow indicator lamp lights up for approximately 1 minute while the engine is running.	<p>At extremely low temperatures, the engine may not start. There is a malfunction in the preglow system.</p> <ul style="list-style-type: none"> ► Have any malfunction rectified at a qualified specialist workshop.
 The yellow air filter indicator lamp is lit while the engine is running.	<p>The service limit for the air filter has been reached. The air filter is dirty.</p> <ul style="list-style-type: none"> ► Have the air filter element replaced as soon as possible at a qualified specialist workshop.

Problem	Possible causes/consequences and ► Solutions
 The yellow tire pressure monitor warning lamp comes on.	 WARNING The tire pressure monitor indicates a rapid or severe loss of pressure in at least one tire. <ul style="list-style-type: none"> ► Stop the vehicle without making any extreme steering maneuvers or braking suddenly. Pay attention to the traffic conditions while doing so. ► Check the tires and correct the tire pressure. If a tire continues to lose pressure, it must be replaced. Replace damaged tires immediately. The warning light will go out after the flat tire has been rectified and you have been driving for a few minutes. ► Vehicles with steering wheel buttons: also observe the messages in the display (► page 199).
 US vehicles only: The yellow tire pressure monitor warning lamp flashes for 60 seconds and then remains lit.	The tire pressure monitor has malfunctioned. <ul style="list-style-type: none"> ► Have the tire pressure monitor and the wheels checked at a qualified specialist workshop.
 The yellow water separator indicator lamp is lit when the ignition is switched on.	The water that has collected in the water separator of the fuel filter has reached the maximum level. <ul style="list-style-type: none"> ► Drain the water separator (► page 257).
 The yellow washer fluid level indicator lamp for the windshield washer/headlamp cleaning system is lit after the engine is started or while the vehicle is in motion.	The water level is too low. <ul style="list-style-type: none"> ► Add washer fluid (► page 257).

Problem	Possible causes/consequences and ► Solutions
 If you turn the key in the ignition lock to position 2 , the red seat belt warning lamp lights up for approximately 6 seconds.	The warning lamp is to remind you to fasten your seat belt. ► Fasten seat belt (▷ page 48).
 When the key is turned to position 2 in the ignition lock, the yellow bulb warning lamp lights up.	One of the exterior lighting bulbs is faulty, with the exception of the perimeter lamps and the trailer lighting. i Depending on the equipment, the bulb failure indicator can fail for all lamps with the exception of the turn signal lamps. ► Replace the faulty bulb as soon as possible (▷ page 100).
 The yellow "door open" indicator lamp is lit while driving.	The vehicle is moving without all doors or the hood being closed. ► Close the doors or hood.
 The yellow "door open" indicator lamp is lit.	The electrical step has retracted or extended only partially or not at all. ► Make sure there is sufficient free space for the electrical step. ► Open or close the sliding door again. ► If the electrical step still does not extend or retract fully, push the step in manually (▷ page 74). Before stepping out, remind the passengers that the step is missing.

Useful information	232
Stowage spaces and stowage compartments	232
Folding table in the twin co-driver's seat	236
Cup holder	236
Bottle holder	237
Ashtray	237
Cigarette lighter	238
12 V socket	238
Mobile phone	239
Additional communications equipment	239

Useful information

This Operator's Manual describes all models as well as standard and optional equipment of your vehicle that were available at the time of going to print. Country-specific variations are possible. Note that your vehicle may not be equipped with all of the described functions. This also applies to systems and functions relevant to safety.

Read the information on qualified specialist workshops (▷ page 26).

Stowage spaces and stowage compartments

Important safety notes

WARNING

If you do not correctly store objects in the vehicle interior, they can slip or be flung around, thus striking vehicle occupants. There is a risk of injury, especially when braking or abruptly changing directions.

- Always store objects so that they cannot be flung around in these or in similar situations.
- Always make sure that objects do not protrude from stowage compartments, parcel nets or stowage nets.
- Close lockable stowage compartments while driving.
- Stow and secure objects that are heavy, hard, pointy, sharp-edged, fragile or too large in the trunk.

In addition, observe the information in the "Loading guidelines" section (▷ page 242).

Glove box

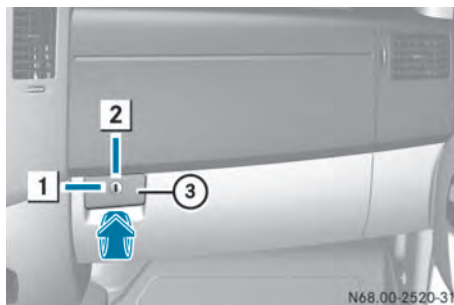

Glove box (example: glove box with a lockable lid)

- 1 Unlocked
- 2 Locked
- 3 Glove box handle

You can lock and unlock the glove box using the mechanical or folding key.

- **To open:** unlock the glove box lid if necessary.
- Pull glove box handle ③ in the direction of the arrow.

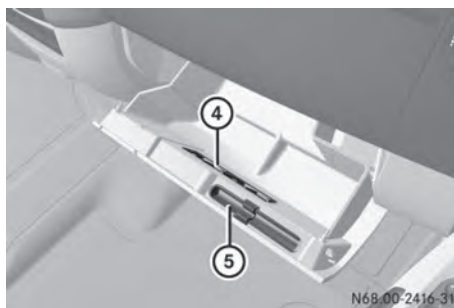

- 4 Card holder
- 5 Pen holder

- **To close:** fold the glove box up and press it until it engages.

Eyeglasses compartment in the overhead control panel



- ▶ **To open:** briefly press cover ①. The eyeglasses compartment folds out.
- ▶ **To close:** press the eyeglasses compartment into the overhead control panel until it engages.

Dashboard stowage compartments

⚠ WARNING

Objects protruding from the stowage compartment above the co-driver front air bag could obstruct or even prevent deployment of the co-driver front air bag. The co-driver front air bag may then fail to provide the intended protection. There is an increased risk of injury.

Do not place any protruding objects in the stowage compartment above the co-driver front air bag.

- ❗ The right and left storage spaces may be loaded with a maximum of 11 lb (5 kg) each.



Stowage space (example: co-driver's side)

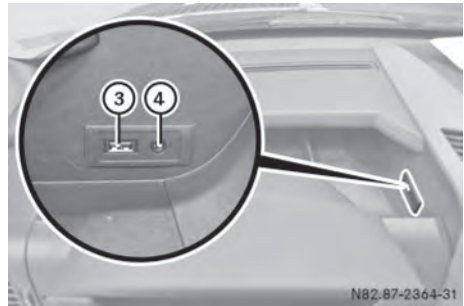

Stowage compartment equipped with smartphone connections

- ③ USB port
- ④ 3.5 mm audio jack
- ⓘ Depending on the vehicle equipment, a USB port and an AUX-in connection is installed in the stowage compartment. A Media Interface is a universal interface for portable audio equipment, e.g. for an iPod® or MP3 player (see the separate audio system operating instructions).

Storage compartment in the center console



Storage compartment on the dashboard above the center console (example with lid)

The storage compartments on and in the center console can be used to store small, light objects.

► **To open:** pull release handle (2).

Lid (1) swings up.

► **To close:** close lid (1) and engage it.

The lid of the storage compartment must remain closed while the vehicle is in motion to ensure that stowed objects are contained safely.

The storage compartments on and in the center console can be used to store small, light objects.

Storage space above the headliner

! The entire storage space may be loaded with a maximum of 66 lb (30 kg).

Do not place high, bulky loads in the storage space. You could otherwise damage the headliner in the event of sharp braking.

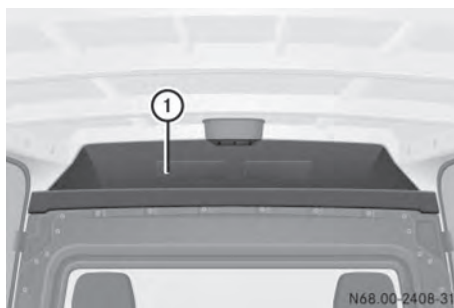

On vehicles with a partition, storage space (1) can only be loaded from the cargo compartment.

Storage space above the windshield

! The right and left storage spaces may be loaded with a maximum of 5.5 lb (2.5 kg) each.

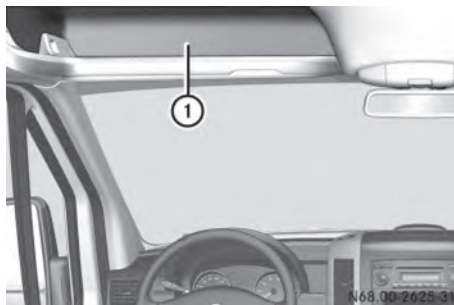

Storage compartment (example: driver's side)

(1) Storage compartment

Stowage compartment under the twin co-driver's seat

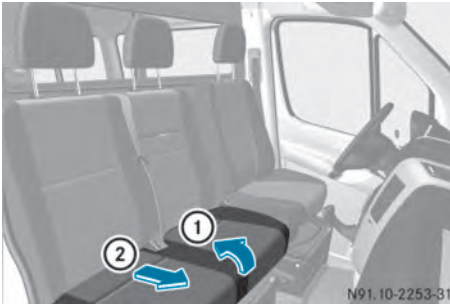

Twin co-driver's seat (example: Cargo Van)

You can stow various articles in the stowage compartment under the twin co-driver's seat.

- ▶ **To fold a seat cushion forwards:** lift the seat cushion out of front anchorage ①.
- ▶ Pull the seat cushion forwards slightly and out of rear anchorage ②.
- ▶ Fold the rear edge of the seat cushion up.
- ▶ **To fold the seat cushion back:** fold down the seat cushion by the rear edge.
- ▶ Slide the seat cushion under the seat backrest into rear anchorage ②.
- ▶ Push down on the seat cushion at the front until it engages in front anchorage ①.

Stowage compartment under the rear bench seat

WARNING

Always secure the folded-up seat cushion with the retainer loop. The seat cushion could otherwise drop down unexpectedly and thereby cause injury to yourself or others.

WARNING

When folding down the seat cushion, make sure that nobody can become trapped.

- ❗ The retainer loop is neither a grab handle for people to use nor a securing point for loads. It may tear if used incorrectly.



For vehicles with a crewcab, you can use the stowage compartment under the rear bench seat to safely store tools and other small items.

- ▶ **To fold up the rear bench seat:** lift seat cushion ① out of the front anchorage and fold it upwards in the direction of the arrow.

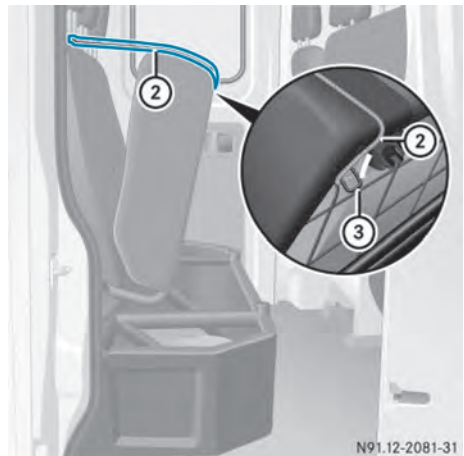

Retainer loops ② are secured to the outer head restraints.

- ▶ Attach retainer loop ② to hook ③ underneath folded-up seat cushion ①.
- ▶ **To fold down the seat cushion:** hold seat cushion ① and detach retainer loop ② from hook ③.
- ▶ Fold down seat cushion ①.
The seat cushion engages automatically.



Paper holder



- ▶ **To open:** press the top of paper holder ①.

Folding table in the twin co-driver's seat

WARNING

If objects, luggage or loads are not secured or not secured sufficiently, they could slip, tip over or be flung around and thereby hit vehicle occupants. There is a risk of injury, particularly in the event of sudden braking or a sudden change in direction.

Always store objects so that they cannot be flung around. Secure objects, luggage or loads against slipping or tipping before the journey.

- ▶ **To fold down the folding table:** pull folding table ① forward by the tab.
 - ▶ Fold folding table ① down in the direction of the arrow and onto the seat cushion.
-  The folding table is equipped with a pen holder and cup holder.

Cup holder

Important safety notes

WARNING

The cup holder cannot hold a container secure whilst traveling. If you use a cup holder whilst traveling, the container may be flung around and liquid may be spilled. The vehicle occupants may come into contact with the liquid and if it is hot, they may be scalded. You may be distracted from the traffic conditions and you could lose control of the vehicle. There is a risk of an accident and injury.

Only use the cup holder when the vehicle is stationary. Only use the cup holder for containers of the right size. Always close the container, particularly if the liquid is hot.

-  Do not use the cup holder recesses as ashtrays. This could damage the cup holders.

Cup holders in the dashboard

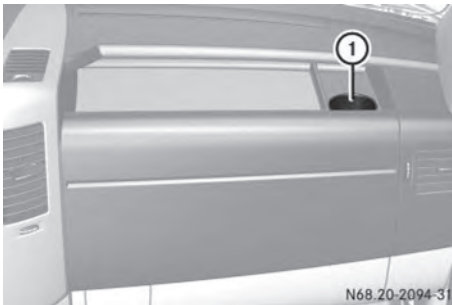

Cup holder in dashboard stowage compartment (example: right-hand side of vehicle)

① Cup holder

i If your vehicle is equipped with a twin co-driver's seat, you will find further cup holders (▷ page 236) in the folding table.

Cup holders in the center console

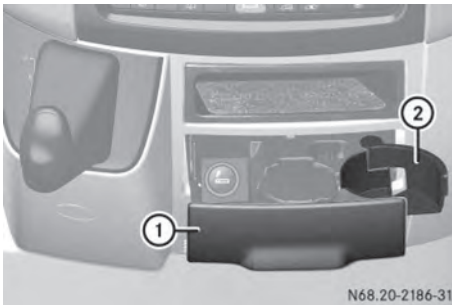

Cup holders in the center console

- ▶ **To open:** pull out ashtray compartment ① by the recess. Clamping arm ② of the cup holder opens out fully.
- i** Vehicles with the non-smoking package have an additional cup holder instead of the ashtray.
- ▶ Place the beverage container into the cup holder and push clamping arm ② against the container.
- ▶ **To close:** push ashtray compartment ① into the center console until it engages.

Bottle holder



Bottle holders ① in the front doors (example: co-driver's door)

Ashtray

Ashtray in the center console

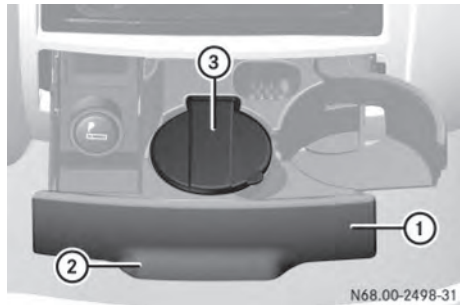

Ashtray in the center console

- ▶ Pull ashtray compartment ① out by recess ②.
- ▶ **To open:** fold cover ③ upwards.
- ▶ **To remove the insert:** hold the ashtray by the recesses on the left and right and pull the insert out to empty it.
- ▶ **To replace the insert:** press it down into the holder as shown. Make sure that the insert is inserted correctly. Otherwise you will not be able to close ashtray compartment ①.

Ashtrays in the passenger compartment



Ashtrays on the left and right in the side trim panels

- ▶ **To open:** fold out the ashtray.
- ▶ **To remove the insert:** press retaining clip ① down and remove the ashtray from the trim.
- ▶ **To replace the insert:** insert the ashtray down into the trim and close it.

Cigarette lighter

WARNING

You can burn yourself if you touch the hot heating element or the socket of the cigarette lighter.

In addition, flammable materials can ignite if:

- the hot cigarette lighter falls
- a child holds the hot cigarette lighter to objects, for example

There is a risk of fire and injury.

Always hold the cigarette lighter by the knob. Always make sure that the cigarette lighter is out of reach of children. Never leave children unsupervised in the vehicle.

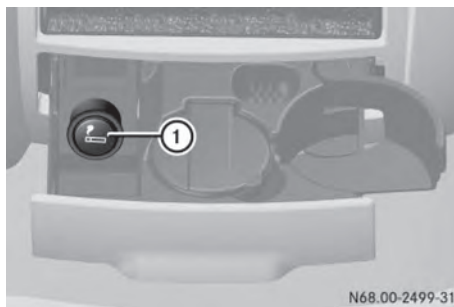

- ▶ **To use the cigarette lighter:** turn the key to position 1 in the ignition lock.
- ▶ Press in cigarette lighter ①. The cigarette lighter will pop out automatically when the heating element is red-hot.
- ▶ Pull the cigarette lighter out of the socket by its handle.

12 V socket



Socket on the lower section of the center console
① 12 V socket (25 A)

The 12 V sockets for accessories are:

- on the lower section of the center console (12 V, 25 A)
- on the inside of the driver's seat frame (12 V, 15 A)
- in the respective corner trim next to the rear doors in the passenger compartment (12 V, 15 A)
- in the load compartment next to the left rear door (12 V, 15 A)

You can use the 12 V sockets (15 A) for accessories with a maximum power consumption of 180 W. You can connect accessories with a maximum power consumption of 300 W to the 12 V socket (25 A) on the lower section of the center console.

- i** The sockets are supplied with power even when the key is removed from the ignition lock. If accessories, e.g. a coolbox, remain connected while the engine is not running, the battery will discharge.

Mobile phone

Important safety notes

WARNING

If you operate information systems and communication equipment integrated in the vehicle while driving, you will be distracted from traffic conditions. You could also lose control of the vehicle. There is a risk of an accident. Only operate the equipment when the traffic situation permits. If you are not sure that this is possible, park the vehicle paying attention to traffic conditions and operate the equipment when the vehicle is stationary.

You must observe the legal requirements for the country in which you are currently driving when operating mobile phones.

Bear in mind that at a speed of just 30 mph (approximately 50 km/h), your vehicle is covering a distance of 44 feet (approximately 14 m) every second.

You and others can suffer health-related damage through electromagnetic radiation. By using an exterior antenna, a possible health risk caused by electromagnetic fields, as discussed in scientific circles, is taken into account. Only have the exterior antenna installed by a qualified specialist workshop.

We recommend the use of an approved exterior antenna for operating the mobile phone. Only in this way can optimal mobile phone reception quality in the vehicle be ensured

and mutual interference between the vehicle electronics and mobile phones minimized.

Observe the legal requirements for each individual country.

Mobile phone pre-installation

The mobile phone pre-installation includes a hands-free system integrated into the vehicle. The microphone for the hands-free system is installed in the overhead control panel or in the overhead stowage compartment together with the front interior light.

In order to use the hands-free system, you will need a special bracket. The Sprinter accessories include brackets for various mobile phone models.

- i** Mobile phone brackets which are available from various manufacturers on the open market are not compatible with the Sprinter telephone system. You can recognize suitable holders for your mobile phone by the imprinted star and the B6 spare part number on the back of the bracket.

Detailed instructions for use can be found in the operating instructions for the mobile phone bracket and in the separate operating instructions for the mobile phone pre-installation.

- i** The mobile phone battery is charged depending on the condition of charge and the position of the key in the ignition lock. The mobile phone display indicates the charging process.

Additional communications equipment

Important safety notes

WARNING

If you operate mobile communication equipment while driving, you will be distracted from traffic conditions. You could also lose control of the vehicle. There is a risk of an accident.

Only operate this equipment when the vehicle is stationary.

You must observe the legal requirements for the country in which you are currently driving when operating mobile communication equipment.

Please remember, a navigation system does not supply information on the load-bearing capacity of bridges or the overhead clearance of underpasses. The driver remains responsible for safety at all times.

You and others can suffer health-related damage through electromagnetic radiation. By using an exterior antenna, a possible health risk caused by electromagnetic fields, as discussed in scientific circles, is taken into account. Only have the exterior antenna installed by a qualified specialist workshop.

You will find information on retrofitting electrical or electronic equipment in the “Vehicle electronics” section (▷ page 318).

Installation for PND mobile navigation devices

You can secure a personal navigation device (Personal Navigation Device PND) using a commercially available adapter.

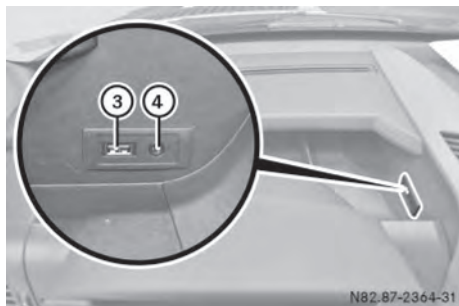

PND connector (on the side behind the instrument cluster)

- ③ USB port
- ④ 3.5 mm audio jack for the PND audio signal (voice announcements)

► **Connecting the PND:** connect the PND ports to the appropriate jacks in the vehicle.

❗ You can also use USB port ③ and 3.5 mm audio jack ④ for external audio sources.

The voice announcements are heard through the radio speakers when you start navigation. The audio source played until this point is then muted for the duration of the voice announcements.

❗ If you use audio devices or personal navigation devices which have been recommended by Mercedes-Benz, you can use all of the functions available, such as the mute function.

You can obtain further information from any authorized Mercedes-Benz Center.

Useful information	242
Loading guidelines	242
Load distribution	244
Securing loads	244
Carrier systems	247

Useful information

This Operator's Manual describes all models as well as standard and optional equipment of your vehicle that were available at the time of going to print. Country-specific variations are possible. Note that your vehicle may not be equipped with all of the described functions. This also applies to systems and functions relevant to safety.

Read the information on qualified specialist workshops (▷ page 26).

Loading guidelines

Important safety notes

WARNING

As a result of improperly placed or unevenly distributed loads, the center of gravity of the load being transported may be too high or too far back. This can significantly impair handling as well as steering and braking characteristics. There is a risk of an accident.

Always make sure that the center of gravity of the load is:

- between the axles
and
- as low as possible, near the rear axle.

WARNING

When objects are unsecured or inadequately secured, they can slip, turn over or be thrown about, striking vehicle occupants. This also applies to:

- luggage or loads
- a rear bench seat which has been removed and is being transported in the vehicle in an exceptional case.

There is a risk of injury, particularly in the event of braking maneuvers or abrupt changes in direction.

Always stow objects in such a way that they cannot be tossed about. Before traveling, secure objects, luggage or loads to prevent

them slipping or tipping over. If you remove a rear bench seat, it is advisable to store it outside the vehicle.

WARNING

When the permissible wheel loads, axle loads and/or the maximum permissible gross vehicle weight are exceeded, driving safety is compromised. The handling as well as steering and braking characteristics may be significantly impaired. Overloaded tires may overheat, causing them to burst. There is a risk of an accident.

When transporting a load, always observe the permissible wheel loads, axle loads and the maximum permissible gross vehicle weight for the vehicle (including occupants).

WARNING

When you load the roof, the center of gravity of the vehicle rises and the driving characteristics change. If you exceed the maximum roof load, the driving characteristics, as well as steering and braking, will be greatly impaired. There is a risk of an accident.

Never exceed the maximum roof load and adjust your driving style.

 If you are using a roof carrier, observe the maximum roof load and maximum roof carrier load.

You will find information about the maximum roof load in the "Technical data" section (▷ page 331) and information about roof carriers in the "Carrier systems" section (▷ page 247).

- Do not stack luggage or loads higher than the backrests.
- Stow objects preferably in the cargo compartment.
- When transporting luggage, always use the cargo tie-down rings and a parcel net, if present.
- Use cargo tie-down rings and fasteners which are suitable for the weight and size of the load.

Always observe the operating instructions of the respective manufacturer when using suitable load securing aids or tie downs. In particular, the information on service life.

Load securing aids and tie downs may not be used, for example, if:

- identification marks are missing or illegible
- there are yarn breakages, damage to bearing seams or other signs of tearing
- there are signs of shearing, deformation, pinching or other damage
- there is damage to clamping or connecting elements

Such load securing aids and tie downs are worn; they should not be used and must be replaced. If you use load securing aids or tie downs which are worn, the load may not be sufficiently secured and could cause damage to property.

After an accident, the following must be checked at a specialist workshop:

- Cargo compartment floor
- Load surface
- Cargo tie-down rings
- Tie downs

Otherwise, the load may not be correctly secured the next time anything is stowed.

Even if you follow all loading guidelines, the load increases the risk of injury in the event of an accident. Observe the tips in the "Securing luggage/loads" (> page 244) and "Load distribution" (> page 244) sections.

Before loading

! The anti-slip mats cannot be used for securing goods and must be replaced when they show signs of:

- Permanent deformation and crushing
- Crack formation
- Cuts

▶ **Tire pressure:** check the tire pressure and correct if necessary (> page 290).

▶ **Cargo compartment floor:** clean the cargo compartment floor.

The cargo compartment floor must be free from oil and dust, dry and swept clean to prevent the load from slipping.

▶ Place non-slip mats (anti-slip mats) on the cargo compartment floor if necessary.

During loading

! On passenger van versions with maximum seating layout, the permissible rear axle load would be exceeded if the full payload were to be loaded in the cargo compartment.

▶ Observe the gross axle weight rating and permissible gross vehicle weight for your vehicle.

Take into account that your vehicle's curb weight is increased if accessories or optional equipment are installed. The maximum payload is thus reduced.

▶ Observe the notes on load distribution (> page 244).

The overall center of gravity of the load should always be as low as possible, centered and between the axles near the rear axle.

▶ Secure the load (> page 244).

Always observe the relevant country-specific legal requirements, laws and regulations.

Checks after loading

WARNING

Combustion engines emit poisonous exhaust gases, such as carbon monoxide. If the sliding door or rear door is open when the engine is running, exhaust gases can enter the vehicle interior, especially during the journey. There is a risk of poisoning.

Always switch off the engine before opening the sliding door or rear door. Never drive the vehicle when the sliding door or rear door is open.

- ▶ **Securing loads:** check that the load is secure before every journey and at regular intervals during a long journey, and correct if necessary.
- ▶ **Doors:** close the sliding doors and rear doors.
- ▶ **Tire pressure:** adjust the tire pressures according to the vehicle load (▷ page 290).
- ▶ **Driving style:** adapt your driving style according to the vehicle load.

Load distribution

General notes

! Excessive loads on individual points of the cargo floor or on the load surface impair vehicle handling characteristics and could cause damage to the floor covering.

The overall center of gravity of the load should always be as low as possible, centered and between the axles near the rear axle.

On Cargo Vans/Passenger Vans:

- ▶ Always transport loads in the cargo compartment.
- ▶ Always place the load against the backrests of the rear bench seat.
- ▶ Move large and heavy loads as far towards the front of the vehicle as possible against the rear bench seat. Stow the load flush with the rear bench seat.
- ▶ Always additionally secure the load with suitable load-securing aids or tie downs.

Observe the following notes:

- Do not stack loads higher than the upper edge of the backrests.
- Transport loads behind seats that are not occupied.
- If the rear bench seat is not occupied, insert the seat belts crosswise into the buckle of the opposite seat belt.

Securing loads

Important safety notes

WARNING

If you attach the tie-down incorrectly when securing the load, the following may occur in the event of abrupt changes in direction, braking maneuvers or an accident:

- the cargo tie-down rings may become detached or the tie-down may tear if the permissible load is exceeded
- the load may not be restrained.

This may cause the load to slip, tip over or be tossed about, striking vehicle occupants. There is a risk of an accident and injury.

Always tension the tie-downs in the proper manner and only between the described cargo tie-down rings. Always use tie-downs designed specifically for the loads.

WARNING

You may not transport anyone in the cargo compartment or on the load surface. Never let more people ride in the vehicle than there are seat belts available. Make sure everyone riding in the vehicle is correctly restrained with a separate seat belt. Never use a seat belt for more than one person at a time.

! Observe the information on the maximum loading capacity of the individual cargo tie-down points.

If you use several cargo tie-down points to secure a load, you must always take the

maximum loading capacity of the weakest cargo tie-down point into account.

If you brake hard, for example, the forces acting could be up to several times the weight force of the load. Always use multiple cargo tie-down points in order to distribute the force absorption. Load the anchorages evenly.

Spread the load evenly between the cargo tie-down points or tie-down rings.

Please also refer to the notes about qualified specialist workshops (▷ page 26).

Always observe the operating instructions or the notes of the lashing strap manufacturer for the operation of the lashing strap.

Information about the maximum loading capacity of the cargo tie-down points can be found in the "Technical data" section (▷ page 331).

As the driver, you are responsible for ensuring that:

- The applicable requirements and guidelines relating to load-securing practices must be met.

If this is not the case, this may constitute a punishable offense, depending on local legislation and any ensuing consequences.

You should therefore observe the respective legal requirements for the relevant country.

Make sure that the load is secure before every journey and at regular intervals during a long journey. Correct an incorrectly or inadequately secured load if necessary.

You can obtain information about securing the load correctly from the manufacturer of the load securing aids or tie down for securing the load.

- ▶ Fill spaces between the load and the cargo compartment walls or wheel housings (form-locking). Use rigid load securing aids, such as wedges, wooden fixings or padding.
- ▶ Attach secured and stabilized loads in all directions. Use the cargo tie-down points

or cargo tie-down rings and the loading rails in the cargo compartment or on the cargo area.

Only use tie downs, such as lashing rods or lashing nets and lashing straps, that have been tested in accordance with current standards (e.g. DIN EN).

Always use the cargo tie-down rings closest to the load to secure it and pad sharp edges for protection.

Loads, and heavy loads in particular, should preferably be secured using the cargo tie-down rings.

- ❗ Tie downs tested in accordance with current standards (e.g. DIN EN) are available at any qualified specialist workshop.

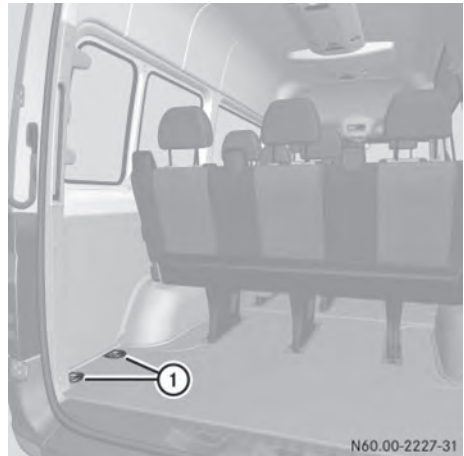

Cargo tie-down point (example: Passenger Van)
 ① Cargo tie-down rings

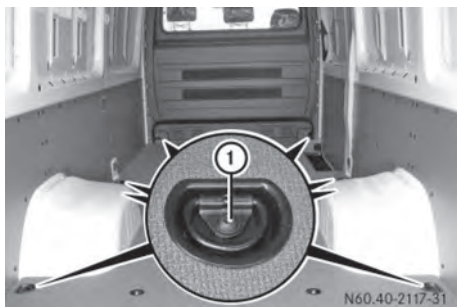

Cargo tie-down point (example: Cargo Van without loading rails)

- ① Cargo tie-down rings

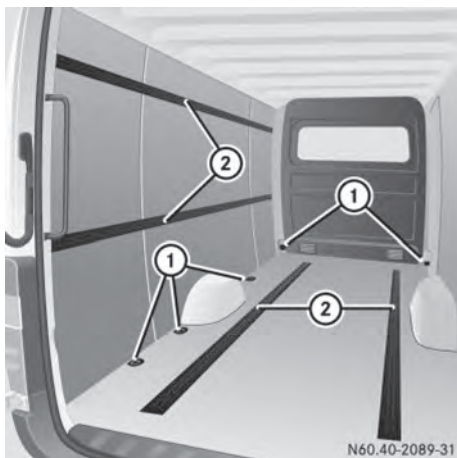

Cargo tie-down point (example: Cargo Van with loading rails)

- ① Cargo tie-down rings
② Load rails

Secure loose loads with a tested lashing net or a tarpaulin.

- ▶ Always fasten the lashing net or tarpaulin to all available cargo tie-down points. Make sure that the retaining hooks are secured against accidental opening.

If your vehicle is equipped with loading rails ② in the floor, you can place lashing rods directly in front of and behind the load. The lashing rods directly absorb the potential shifting forces.

Securing loads on the cargo compartment floor by lashing them down is only recommended for lightweight loads. Place non-slip mats (anti-slip mats) under the load to increase load security.

Installing/removing cargo tie down rings for the load rails

⚠ WARNING

If the cargo tie-down ring is not properly installed, it may slip or become detached in the event of abrupt changes in direction, braking maneuvers or an accident. This may cause objects, luggage or the load to slip, tip over or be tossed about, striking vehicle occupants. There is a risk of injury.

Before using the cargo tie-down rings, always make sure they are properly installed and cannot be moved.

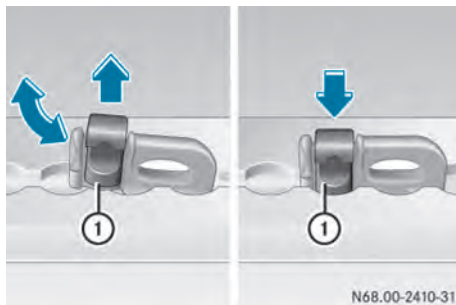

- ▶ **To install:** slide the cargo tie-down ring through a recess in the loading rail close to the load until locking mechanism ① engages in the recess.

- ▶ **i** When you pull locking mechanism ① up and out of the recess, the cargo tie-down ring is able to move within the loading rail. Make sure that locking mechanism ① is always engaged in a recess.

- ▶ Check the cargo tie-down ring for firm seating.
- ▶ **To remove:** pull locking mechanism ① up and pull the cargo tie-down ring towards

the locking mechanism and out of the loading rail through a recess.

Carrier systems

WARNING

When you load the roof, the center of gravity of the vehicle rises and the driving characteristics change. If you exceed the maximum roof load, the driving characteristics, as well as steering and braking, will be greatly impaired. There is a risk of an accident.

Never exceed the maximum roof load and adjust your driving style.

You can find information about the maximum roof load in the "Technical data" section (> page 331).

Make sure that:

- the screws for the roof carrier are tightened in the sliding blocks to a torque of 6.0 – 7.4 lb-ft (8 – 10 Nm)
- the bolts, when tightened, do not touch the rails.
- the slot nuts are not located in the area of the plastic caps.
- the slot nuts have the right cross-section.
- the mounting rails in the interior are free of dirt.
- the screws are retightened evenly after approximately 300 miles (500 km).

We recommend that you only use roof racks tested and approved by Sprinter. These help avoid vehicle damage.

 If you want to retrofit securing rails, have it done at a qualified specialist workshop. You could otherwise damage the vehicle.

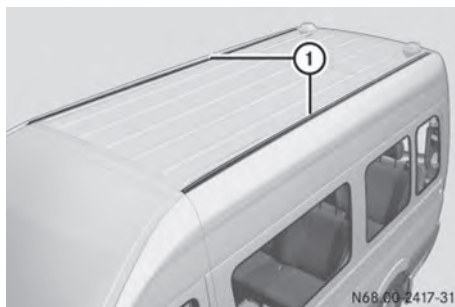

① Securing rails

It is possible to install a roof carrier if your vehicle is equipped with securing rails on the roof. Special mounting elements (grooved plates) are available as accessories.

These mounting elements are available at any authorized Sprinter Dealer.

Useful information	250
Engine compartment	250
Vehicle interior	258
Maintenance	258
Battery	260
Care	267

Useful information

This Operator's Manual describes all models as well as standard and optional equipment of your vehicle that were available at the time of going to print. Country-specific variations are possible. Note that your vehicle may not be equipped with all of the described functions. This also applies to systems and functions relevant to safety.

Read the information on qualified specialist workshops (▷ page 26).

Engine compartment

Hood

Opening the hood

WARNING

If the hood is unlatched, it may open up when the vehicle is in motion and block your view. There is a risk of an accident.
Never unlatch the hood while driving.

WARNING

Opening the hood when the engine is overheated or when there is a fire in the engine compartment could expose you to hot gases or other service products. There is a risk of injury.

Let an overheated engine cool down before opening the hood. If there is a fire in the engine compartment, keep the hood closed and contact the fire department.

WARNING

Certain components in the engine compartment, such as the engine, radiator and parts of the exhaust system, can become very hot. Working in the engine compartment poses a risk of injury.

Where possible, let the engine cool down and touch only the components described in the following.

If you have to carry out work in the engine compartment, only touch the following components:

- hood
- oil dipstick
- engine oil filler neck cap
- washer fluid reservoir cap

WARNING

The engine compartment contains moving components. Certain components, such as the radiator fan, may continue to run or start again suddenly when the ignition is off. There is a risk of injury.

If you need to do any work inside the engine compartment:

- switch off the ignition
- never reach into the area where there is a risk of danger from moving components, such as the fan rotation area
- remove jewellery and watches
- keep items of clothing and hair, for example, away from moving parts

WARNING

The fuel injection system operates with a high voltage. If you touch the live components, you could receive an electric shock. There is a risk of injury.

Never touch components of the fuel injection system when the ignition is switched on.

The live components of the fuel injection system are, for example, the injectors.

- ❗ Make sure that the windshield wipers are not folded away from the windshield. You could otherwise damage the windshield wipers or the hood.



Hood release lever in the driver's footwell

- ▶ Stop your vehicle as far away from traffic as possible on level ground.
- ▶ Switch off the engine.
- ▶ Secure the vehicle to prevent it from rolling away.
- ▶ Pull release handle ① on the hood. The hood is released.

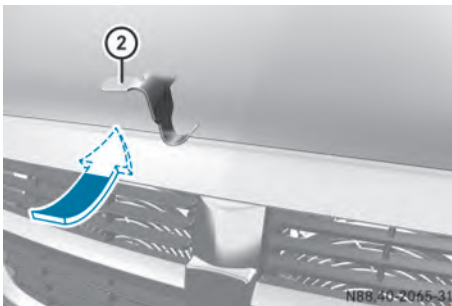

- ▶ Reach into the gap and push grip ② on the hood catch upwards.

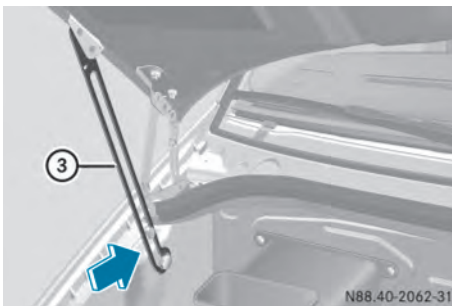



- ▶ Swing the hood upwards until support strut ③ engages and the hood is supported.

Closing the hood

WARNING

If the hood is unlatched, it could tip forward during rapid deceleration of the vehicle and hit persons or objects within its path. There is a risk of an accident and injury. Therefore, always make sure that the hood is closed and locked completely before driving off.

If the hood is not locked and you are already driving at walking pace:

- the yellow  indicator lamp in the instrument cluster goes on for vehicles without steering-wheel buttons.
- the  **Hood open** display appears for vehicles with steering-wheel buttons.

! When you press the support strut back, make sure that you do not press it against the detent position and cause it to bend.

! Do not use your hands to push the hood down. You could damage it otherwise.

- ▶ Lift the hood slightly.
- ▶ Press support strut ③ towards the back.
- ▶ Lower the hood and allow it to fall with momentum from a height of approximately 1 ft (30 cm).

The hood locks audibly.

- ▶ Check that the hood is correctly locked. If the hood can be raised slightly, it is not properly engaged.

i If the hood is not correctly engaged, open the hood again. Let the hood fall with a little more momentum.

Overview of the engine compartment

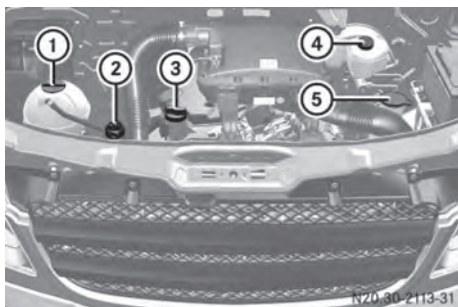

Euro-6 engine

- ① Coolant expansion tank cap (▷ page 255)
- ② DEF filler neck cap⁴ (▷ page 150)
- ③ Engine oil filler neck cap (▷ page 252)
- ④ Brake fluid expansion tank cap (▷ page 256)
- ⑤ Washer fluid reservoir cap (▷ page 257)

Regularly check the fluid level and the assembly for leaks. If you detect fluid loss, e.g. oil flecks on the vehicle parking space, consult a qualified specialist workshop immediately.

Engine oil

General notes

! Engine oil gets dirty in the course of operation and its quality and volume are gradually diminished. Regularly check the oil level, and top up or have it replaced as needed.

Observe the information on engine oils and oil consumption in the "Technical data" section (▷ page 326).

You can check the oil level in the engine:

- on the display of the on-board computer
- with the oil dipstick

Checking the oil level shown in the display

If at extremely low temperatures no engine oil level is displayed after 5 minutes, repeat the engine oil level check after another 5 minutes.

If an oil level reading is still not displayed, check the engine oil level with the dipstick. Have the oil level display checked at a qualified specialist workshop.

Only check the oil level when the engine is at normal operating temperature.

▶ Park the vehicle on a level surface.

▶ Switch off the engine.

▶ Wait for five minutes.

▶ Turn the key to position **2** in the ignition lock.

The display is activated.

▶ **Vehicles without steering wheel buttons:** press the **(M)** menu button on the instrument cluster (▷ page 34) repeatedly until the display shows the  symbol.

The **--:--** display message appears in the display while the engine oil level measurement is running.

▶ **Vehicles with steering wheel buttons:** press the  service button on the instrument cluster (▷ page 34).

The  **Engine oil level Measuring in progress** display message appears in the display while the engine oil level measurement is in progress.

Display message for vehicles without steering-wheel buttons: the display may show the following messages after the engine oil level measurement.

	Action
OK	▶ Do not add oil.

⁴ For Cargo Van/Passenger Van only.

- 1.0 qts	▶ Add the amount of oil shown (▷ page 254).
- 1.5 qts	▶ Check the engine oil level again after a few minutes.
- 2.0 qts	
HI	The oil level is too high. ▶ Have excess oil removed.

Measurement units in the display:

- qts USA only
- ltr Canada only

Display message for vehicles with steering-wheel buttons: the display may show the following messages after the engine oil level measurement.

 Action	
Engine oil level OK	▶ Do not add oil.
Engine oil Add 1.0quart	▶ Add the amount of oil shown (▷ page 254). ▶ Check the engine oil level again after a few minutes.
Engine oil Add 1.5quart	
Engine oil Add 2.0quart	
Engine oil level Reduce oil level	The oil level is too high. ▶ Have excess oil removed.
Eng. oil lev. Turn ignition on for level	▶ Turn the key to position 2 in the ignition lock.

Observe wait. period	▶ Repeat the engine oil measurement after about 5 minutes if the engine is at normal operating temperature. ▶ Repeat the engine oil measurement after about 30 minutes if the engine is not at normal operating temperature.
Engine oil level Not when eng. running	▶ Switch off the engine and wait for approximately 5 minutes if the engine is at normal operating temperature. Then, perform the engine oil measurement.

Measurement units in the display:

- qts USA only
- ltr Canada only

Checking the oil level using the oil dipstick

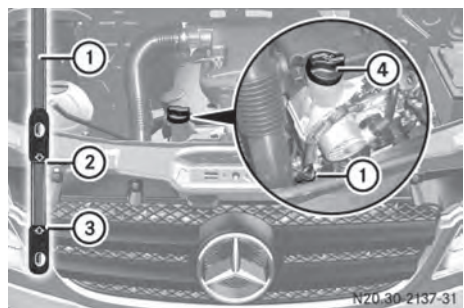

N20_30_2137-31

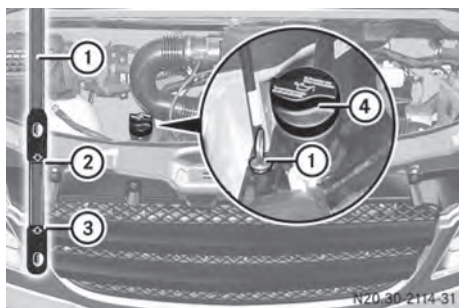

For vehicles with a red oil dipstick, only check the oil level when the engine is at normal operating temperature:

- ▶ Stop your vehicle as far away from traffic as possible on level ground.
- ▶ Secure the vehicle to prevent it from rolling away.
- ▶ Switch off the engine.
- ▶ Wait for five minutes.

For vehicles with a yellow oil dipstick, only check the oil level when the engine is cold.

- ▶ Stop your vehicle as far away from traffic as possible on level ground.
- ▶ Secure the vehicle to prevent it from rolling away.

▶ Open the hood (▶ page 250).

- ▶ Pull out oil dipstick ①.
- ▶ Wipe oil dipstick ① using a lint-free cloth.
- ▶ Insert oil dipstick ① back into the guide tube as far as it will go and remove it again. If the level is between minimum mark ③ and maximum mark ②, the oil level is correct.
- ▶ If the oil level has dropped to or below minimum mark ③, open cap ④ and add engine oil (▶ page 254). The difference in quantity between marks ② and ③ is approximately 2 US quarts (2 l).

▶ Close the hood.

OM651 4-cylinder diesel engine:

At outside temperatures between 32 °F (-0 °C) and 86 °F (30 °C) you can measure the oil level when cold.

Measuring the engine oil when the engine is cold is less precise than measuring when the engine is at normal operating temperature.

When the appropriate warning is shown in the display

▶ Adding engine oil (▶ page 254)

Or

▶ Have engine oil siphoned off.

Adding engine oil

WARNING

If engine oil comes into contact with hot components in the engine compartment, it may ignite. There is a risk of fire and injury.

Make sure that engine oil is not spilled next to the filler neck. Let the engine cool down and thoroughly clean the engine oil off the components before starting the engine.

 The alternator is located below the engine oil filler neck. If engine oil spills onto the alternator, there is a danger of alternator damage. Be very careful when adding engine oil.

Environmental note

When adding oil, take care not to spill any. If oil enters the soil or waterways, it is harmful to the environment.

 Do not add too much oil. Adding too much engine oil can result in damage to the engine or to the catalytic converter. Have excess engine oil siphoned off.

 Do not use any additives in the engine oil. This could damage the engine.

▶ Open the hood (▶ page 250).

▶ Unscrew and remove cap ④.

▶ Add engine oil.

- ▶ Place cap ① on the filler neck and tighten. When doing so, make sure that the cap engages correctly.
- ▶ Check the oil level with the oil dipstick (▷ page 253) or on the display (▷ page 252).
- ▶ Close the hood.

Coolant

WARNING

The engine cooling system is pressurized, particularly when the engine is warm. When opening the cap, you could be scalded by hot coolant spraying out. There is a risk of injury. Let the engine cool down before opening the cap. Wear eye and hand protection when opening the cap. Open the cap slowly half a turn to allow pressure to escape.

Only check the coolant level and/or fill the coolant if the vehicle is on a level surface and the engine has cooled down. The coolant temperature must be below 122 °F (50 °C).

- ❗ Check the engine cooling and heating system regularly for leaks.

If a large quantity of coolant is lost, have the cause traced and rectified at a qualified specialist workshop.

WARNING

Coolant contains glycol and is therefore toxic. Do not swallow the coolant. See a doctor immediately if you swallow coolant.

Make sure that coolant does not come into contact with skin, eyes or clothing. In case of contact with eyes, rinse immediately with plenty of clean water. Clean affected areas of skin and clothing with soap and water immediately. Change any affected clothing immediately.

WARNING

If antifreeze comes into contact with hot components in the engine compartment, it may ignite. There is a risk of fire and injury.

Let the engine cool down before you add antifreeze. Make sure that antifreeze is not spilled next to the filler neck. Thoroughly clean the antifreeze from components before starting the engine.

- ❗ Take care not to spill any coolant on painted surfaces. You could otherwise damage the paintwork.

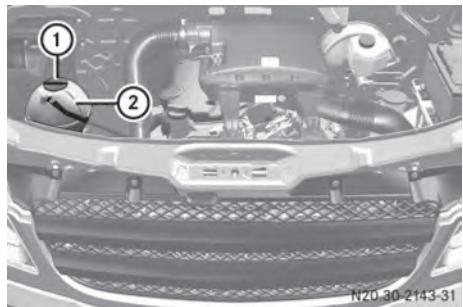

Example: cap and coolant expansion tank

Checking the coolant level

- ▶ Stop your vehicle as far away from traffic as possible on level ground.
- ▶ Switch off the engine.
- ▶ Secure the vehicle to prevent it from rolling away.
- ▶ Open the hood (▷ page 250).
- ▶ Slowly turn cap ① half a turn counter-clockwise to allow excess pressure to escape.
- ▶ Turn cap ① further and remove it.
- ▶ Check the coolant level. If the coolant reaches the maximum mark on coolant expansion tank ②, there is enough coolant in coolant expansion tank ②.

Adding coolant

- ▶ If the coolant drops under the minimum mark on coolant expansion tank ②, add coolant to the maximum mark. Observe the information on coolant mixture ratio and water quality in the "Technical data" section (▷ page 329). To prevent damage to the engine cooling system, use only approved corrosion inhibitor/anti-freeze that comply with the Mercedes-Benz Specifications for Service Products.
- ▶ Replace cap ① and turn it clockwise to tighten.
- ▶ Start the engine.
- ▶ After approximately 5 minutes, switch off the engine and allow it to cool down.
- ▶ Check the coolant level again and add coolant if necessary.
- ▶ Close the hood.

Brake fluid

WARNING

Service products may be poisonous and hazardous to health. There is a risk of injury.

Comply with instructions on the use, storage and disposal of service products on the labels of the respective original containers. Always store service products sealed in their original containers. Always keep service products out of the reach of children.

Brake fluid is hazardous to health. Also observe the safety notes in the "Service products and capacities" section (▷ page 320).

WARNING

The brake fluid constantly absorbs moisture from the air. This lowers the boiling point of the brake fluid. If the boiling point of the brake fluid is too low, vapor pockets may form in the brake system when the brakes are applied hard. This would impair braking efficiency. There is a risk of an accident.

You should have the brake fluid renewed at the specified intervals.

-  Brake fluid corrodes paint, plastic and rubber. If paint, plastic or rubber has come into contact with brake fluid, rinse with water immediately.

Have the brake fluid renewed every 2 years at a qualified specialist workshop. Observe the information on brake fluid in the "Technical data" section (▷ page 328).

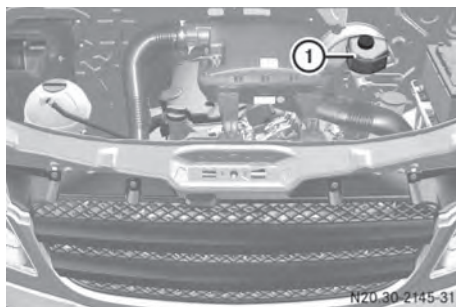

Check the brake fluid level regularly, e.g. weekly or when refueling.

Checking the brake fluid level

- ▶ Stop your vehicle as far away from traffic as possible on level ground.
- ▶ Switch off the engine.
- ▶ Secure the vehicle to prevent it from rolling away.
- ▶ Open the hood (▷ page 250).
- ▶ Check the brake fluid level. The brake fluid level is correct if the level is between the MIN mark and MAX mark on brake fluid reservoir ①.
- ▶ Close the hood.

-  If the brake fluid level in the brake fluid reservoir has fallen to the MIN mark or below, check the brake system immediately for leaks. Also check the thickness of the brake linings. Visit a qualified specialist workshop immediately.

Do not add brake fluid. This does not correct the malfunction.

Washer fluid

WARNING

Windshield washer concentrate is highly flammable. If it comes into contact with hot engine components or the exhaust system it could ignite. There is a risk of fire and injury.

Make sure that no windshield washer concentrate is spilled next to the filler neck.

- !** Only use washer fluid that is suitable for plastic lamp lenses, e.g. MB SummerFit or MB WinterFit. Unsuitable washer fluid could damage the plastic lenses of the headlamps.

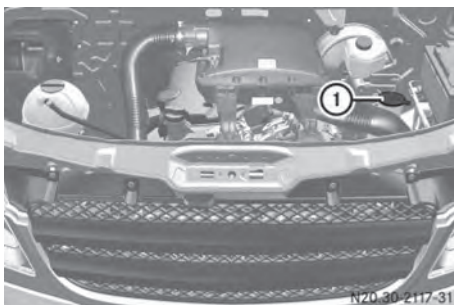

Example: washer fluid reservoir

Add windshield washer concentrate to the washer fluid all year round. Observe the information on washer fluid in the "Technical data" section (▷ page 330).

Adding washer fluid

- ▶ Mix the washer fluid to the appropriate mixing ratio in a container beforehand.
- ▶ Open the hood (▷ page 250).
- ▶ Pull cap **1** on the washer fluid reservoir upwards at the tab.
- ▶ Add the premixed washer fluid.
- ▶ Press cap **1** onto the filler neck until it engages audibly.
- ▶ Close the hood.

Fuel system

Draining the fuel filter

WARNING

Fuel is highly flammable. Improper handling of fuel creates a risk of fire and explosion.

Avoid fire, open flames, smoking and creating sparks under all circumstances. Switch off the ignition and auxiliary heating before carrying out work to the fuel system. Always wear protective gloves.

Environmental note

Dispose of the water-fuel mixture in an environmentally responsible manner.

- !** When the  indicator lamp lights up, drain the fuel filter with water separator immediately. Otherwise, the engine may be damaged.

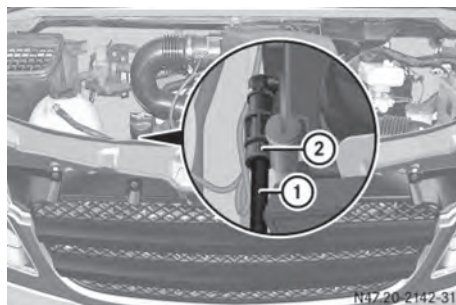

If the  indicator lamp in the instrument cluster goes on, drain the fuel filter with water separator **3** immediately.

- i** We recommend that you have this maintenance work carried out at a qualified specialist workshop.
- ▶ Park the vehicle safely and secure it from rolling away.
- ▶ Switch off the auxiliary heating system .
- ▶ Switch off the engine.
- ▶ Open the hood (▷ page 250).
- ▶ Place a suitable receptacle under drain hose **1**.

- ▶ Turn the key to position **2** in the ignition lock.
- ▶ Open drain plug **②** immediately until the water/fuel mixture flows out of drain hose **①**.
- ▶ Screw in drain plug **②** as soon as approximately 0.2 US qt (0.2 l) of the water/fuel mixture have been collected.

i The electrical fuel pump halts the flow of the water/fuel mixture after 30 seconds.

- ▶ After draining, turn the key back to position **0** in the ignition lock.
- ▶ Dispose of the collected water/fuel mixture in an environmentally responsible manner, e.g. at a qualified specialist workshop.
- ▶ Check drain plug **②**. The drain plug must be closed.
When the engine is running and drain hose **②** is open, fuel is lost through drain hose **①**.

- ▶ Close the hood.

If the  indicator lamp does not go out after draining:

- ▶ Drain the fuel filter again.
- ▶ If the  indicator lamp does not go out after draining for the second time, have the cause checked immediately at a qualified specialist workshop.

Vehicle interior

Air filter for the rear-compartment air conditioning

- !** Regularly check the air filters for visible dirt. Clean or replace a dirty filter mat. The dirt may otherwise lead to damage to the air-conditioning system.

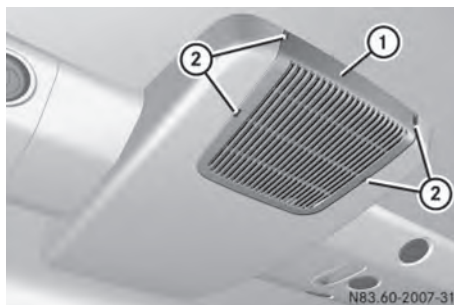

Filter magazine, located on the roof in the rear compartment

An increased amount of sand or dust may collect in the air filter of the rear-compartment air conditioning when you drive on dusty or sandy roads.

- ▶ **To remove the filter mat:** carefully pry cover **①** out of recesses **②** and remove.
- ▶ Remove the filter mat from the air duct.
- ▶ **To clean the filter mat:** wash the dirty filter mat with clear water.
- ▶ Leave the filter mat to dry.
- i** The filter mat must not be cleaned or dried in a machine.
- ▶ **To install the filter mat:** insert the filter mat in cover **①**.
- ▶ Replace and engage cover **①**.

Maintenance

General notes

Environmental note

Observe measures to protect the environment when working on the vehicle. You must observe the legal requirements when disposing of service products, e.g. engine oil. This also includes all components, e.g. filters, which have come into contact with service products. Any qualified specialist workshop can provide information about this.

Dispose of empty containers, cleaning cloths and care products in an environmentally

responsible manner. Comply with the instructions for use of the care products.

Do not run the engine for longer than necessary when the vehicle is stationary.

Before having maintenance and repairs performed, it is essential to read the materials related to the maintenance and repairs:

- the applicable sections of the technical documentation, e.g. the Operator's Manual and workshop information.
- regulations such as industrial safety regulations and accident prevention regulations.

While working under the vehicle, you must secure the vehicle on jack stands with sufficient load capacity.

Never use the jack as a substitute. The vehicle's jack is intended only to raise the vehicle for a short time when changing a wheel. It is not suited for performing maintenance work under the vehicle.

Please also refer to the notes about qualified specialist workshops (▷ page 26).

The scope and regularity of the inspection and maintenance work primarily depend on the often diverse operating conditions. Specialist knowledge beyond the scope of this Operator's Manual is required when carrying out testing and maintenance work. This work should only be carried out by trained staff.

The vehicle's Maintenance Booklet describes the extent and frequency of the maintenance work and contains additional information on the New Vehicle Limited Warranty and on the service products.

- i** Maintenance services must be carried out in accordance with the provisions and recommendations in the Maintenance Booklet.

Not doing so could void the warranty claim and lead to refusal of goodwill gestures after the manufacturer has submitted a damage report.

- i** Observe the information on Sprinter original parts in the "Technical data" section (▷ page 318).

Service interval display

General notes

A service that is due is displayed in the service interval display about 1 month in advance. A message is then displayed while the vehicle is in motion or when the ignition is switched on.

- i** The service interval display does not provide information about the oil level. The service interval display should therefore not be confused with the  engine oil level display.

The service due date is displayed in days or miles (kilometers), depending on the total distance driven.



The symbols or letters on the service display show the type of service that is due.

 or **A** for a minor service



 or **B** for a major service

Service due date display

Vehicles with steering wheel buttons: the following messages may be displayed.

-  **Service A due in ... days**
-  **Service A due in ... mi (km)**
-  **Service A Carry out now**



Vehicles without steering wheel buttons: the following messages may be displayed.



-  for service A
-  for Service B

Additionally, you will see the remaining distance in miles (**mi**) or kilometers (**km**) or the remaining time in days (**d**).

Service due date has been exceeded

Vehicles with steering wheel buttons: if you have missed the service due date, one of the following messages appears in the display and warning tone also sounds.



-  Service A overdue by ... days
-  Service A overdue by ... mi (km)

Vehicles without steering wheel buttons: if you have missed the service due date, the  or  symbol for the service flashes for 10 seconds after the ignition is switched on. A minus sign also appears in front of the service due date.

Calling up the service due date







- ▶ Turn the key to position **2** in the ignition lock.
The display is activated.

Vehicles without steering wheel buttons

- ▶ Press the  menu button on the instrument cluster repeatedly until the  or  symbol for the service appears in the display.

Additionally, you will see the remaining distance in miles (mi) or kilometers (km) or the remaining time in days (d).

Vehicles with steering wheel buttons

- ▶ Press the  or  button on the steering wheel until the standard display (▷ page 189) appears in the display.
- ▶ Press the  or  button on the steering wheel repeatedly until the service message appears in the display, for example:
 -  Service A due in ... days
 -  Service A due in ... mi (km)

Battery

Important safety notes



Risk of explosion. Explosive oxy-hydrogen is produced when batteries are being charged. Only charge batteries in well-ventilated areas.



Risk of explosion. Avoid creating sparks. Avoid open flames and do not smoke in the vicinity of the battery.



Battery acid is caustic. Wear acid-proof protective gloves. If skin or clothes are splashed with acid, neutralize the splashes immediately with soapy water or an acid neutralizer, and then clean the affected areas with water.



Wear eye protection. When mixing water and acid, the liquid can splash into your eyes. Rinse acid splashes to the eyes immediately with clean water and contact a doctor immediately.



Keep children at a safe distance. Children are not able to assess the dangers posed by batteries and acid.



When handling batteries, observe the safety precautions and special protective measures contained in this Operator's Manual.



Environmental note



Batteries contain dangerous substances. It is against the law to dispose of them with the household rubbish. They must be collected separately and recycled to protect the environment.



Dispose of batteries in an environmentally friendly manner. Take discharged batteries to a qualified spe-

cialist workshop or a special collection point for used batteries.

Observe the following notes:

- Have the condition of charge checked for the batteries more frequently if you use the vehicle mainly for short trips or if you leave it parked for an extended period.
In order for the batteries to achieve their maximum possible service life, they must always be sufficiently charged.
- When replacing a battery, only use batteries that are recommended for use in Sprinter vehicles.
- Have the battery removed at a qualified specialist workshop.
- If you intend to leave your vehicle parked for a long period:
 - consult a qualified specialist workshop or
 - switch off the electrical system using the battery main switch (▷ page 136).

i When you park the vehicle, remove the key if you do not require any electrical consumers. The vehicle will then use very little energy, thus conserving battery power.

Installation locations

Your vehicle may be equipped with three batteries, depending on the equipment version:

- a starter battery in the battery case in the driver's footwell
- additional battery in the engine compartment
- auxiliary battery under the driver's seat

Installing/removing the floor covering (starter battery)

WARNING

Objects in the driver's footwell can restrict the pedal travel or obstruct a depressed pedal. The operating and road safety of the vehicle is jeopardized. There is a risk of an accident. Make sure that all objects in the vehicle are stowed correctly, and that they cannot enter the driver's footwell. Install the floormats securely and as specified in order to ensure sufficient clearance for the pedals. Do not use loose floormats and do not place floormats on top of one another.

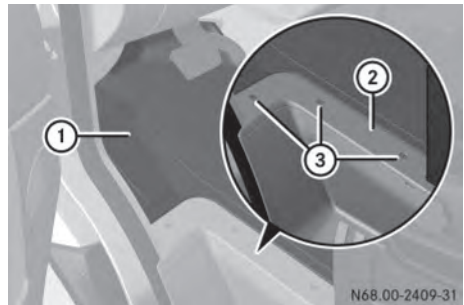

- ▶ Switch off all electrical consumers.
- ▶ **To remove:** remove screws ③ and take off trim ②.
- ▶ Remove floor covering ①.
- ▶ **To install:** place floor covering ① in the driver's footwell.
- ▶ Slide floor covering ① underneath the carrier of the accelerator pedal and align it at the base of the driver's seat and at the door sill.
Make sure that the floor covering does not obstruct the accelerator pedal.
- ▶ Put trim ② in place and screw screws ③ back in.

Disconnecting/connecting the starter battery

Important safety notes

WARNING

During the charging process, a battery produces hydrogen gas. If a short circuit occurs or sparks are created, the hydrogen gas can ignite. There is a risk of an explosion.

- Make sure that the positive terminal of a connected battery does not come into contact with vehicle parts.
- Never place metal objects or tools on a battery.
- It is important that you observe the described order of the battery terminals when connecting and disconnecting a battery.
- When jump-starting, make sure that the battery poles with identical polarity are connected.
- It is particularly important to observe the described order when connecting and disconnecting the jumper cables.
- Never connect or disconnect the battery terminals while the engine is running.

Disconnecting the starter battery

! Switch off the engine and remove the key from the ignition lock before you loosen or disconnect the terminal clamps. You may otherwise destroy electronic components such as the alternator.

Always disconnect the starter battery in the battery case in the driver's footwell first.

! Always disconnect the battery in the order described below. Never swap the terminal clamps. You may otherwise damage the vehicle electronics.

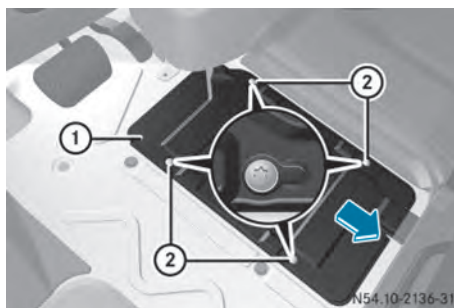

Battery cover in the driver's footwell

- ▶ Switch off all electrical consumers.
- ▶ Switch off the engine and remove the key from the ignition lock.
- ▶ Remove the floor covering in the driver's footwell (> page 261).
- ▶ Loosen screws ② and slide battery cover ① in the direction of the arrow. The screws must protrude beyond the larger recesses.
- ▶ Remove battery cover ① upwards.

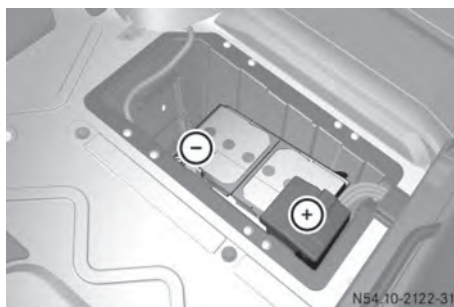

Starter battery in the driver's footwell

- ▶ First loosen and remove the negative terminal clamp so that it is no longer in contact with the terminal.
- ▶ Remove the cover from the positive terminal.
- ▶ Loosen the positive terminal clamp and fold it up to the side together with the pre-fuse box.

Reconnecting the starter battery

! Always connect the battery in the order described below. Never swap the terminal clamps. You may otherwise damage the vehicle electronics.

- ▶ Fold the positive terminal clamp with the pre-fuse box down to the terminal.
- ▶ Connect the positive terminal clamp.
- ▶ Attach the cover to the positive terminal.
- ▶ Connect the negative terminal clamp.
- ▶ Position battery cover ① so that screws ② are positioned over the large recesses.
- ▶ Slide battery cover ① in the direction of travel into the smaller recesses.
- ▶ Tighten screws ②.
- ▶ Install the floor covering in the driver's foot-well (▷ page 261).

Carry out the following work after connecting the battery:

- ▶ Reset the side windows (▷ page 79).

Removing/installing the starter battery

Removing the starter battery

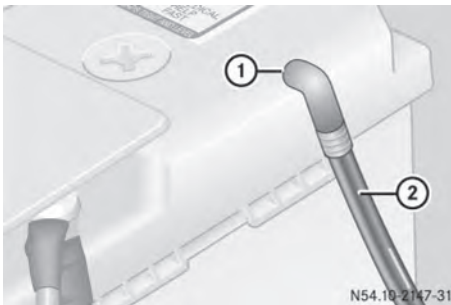

- ▶ Disconnect the battery (▷ page 262).
- ▶ Pull breather hose with connector bracket ② from connection ① on the degassing cover.

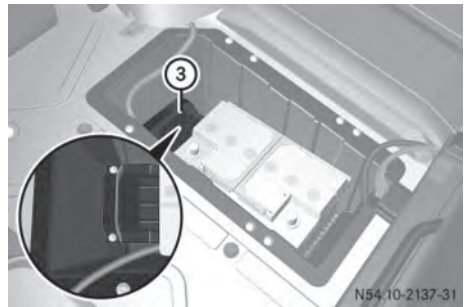

- ▶ Loosen the bolts holding retainer ③, which prevents the battery from moving around.

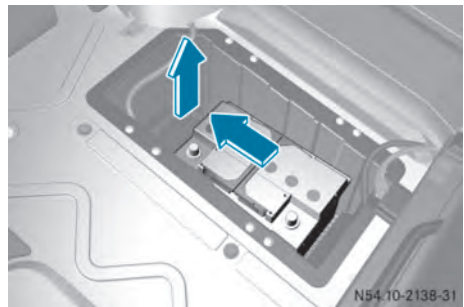

- ▶ Pull retainer ③ upwards.
- ▶ Slide the battery from its anchorage in the direction of travel.
- ▶ Fold the bar of the battery upwards and remove the battery from the battery case.

Installing the starter battery

- ▶ Insert the battery into the battery case.
- ▶ Fold down the bar of the battery.
- ▶ Slide the battery into its anchorage in the opposite direction to the direction of travel.
- ▶ Insert retainer ③.
- ▶ Tighten the bolts on retainer ③ which holds the battery in place.
- ▶ Attach breather hose with connector bracket ② to connection ① of the ventilation cover.
- ▶ Connect the battery (▷ page 262).

Disconnecting and connecting the additional battery (engine compartment)

Important safety notes

WARNING

During the charging process, a battery produces hydrogen gas. If a short circuit occurs or sparks are created, the hydrogen gas can ignite. There is a risk of an explosion.

- Make sure that the positive terminal of a connected battery does not come into contact with vehicle parts.
- Never place metal objects or tools on a battery.
- It is important that you observe the described order of the battery terminals when connecting and disconnecting a battery.
- When jump-starting, make sure that the battery poles with identical polarity are connected.
- It is particularly important to observe the described order when connecting and disconnecting the jumper cables.
- Never connect or disconnect the battery terminals while the engine is running.

Disconnecting the additional battery

- ❗ Switch off the engine and remove the key from the ignition lock before you loosen or disconnect the terminal clamps. You may otherwise destroy electronic components such as the alternator.

Always disconnect the starter battery in the battery case in the driver's footwell first.

- ❗ Always disconnect the battery in the order described below. Never swap the terminal clamps. You may otherwise damage the vehicle electronics.

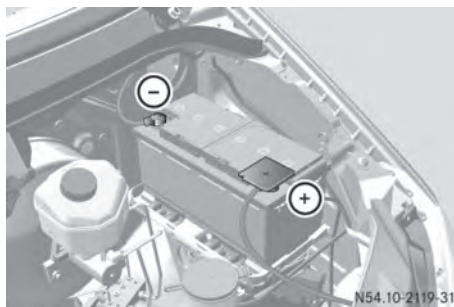

Additional battery in the engine compartment

- ▶ Switch off all electrical consumers.
- ▶ Switch off the engine and remove the key from the ignition lock.
- ▶ Open the hood (> page 250).
- ▶ First loosen and remove the negative terminal clamp so that it is no longer in contact with the terminal.
- ▶ Remove the cover from the positive terminal.
- ▶ Loosen and remove the positive terminal clamp.

Connecting the additional battery

- ❗ Always connect the battery in the order described below. Never swap the terminal clamps. You may otherwise damage the vehicle electronics.

- ▶ Connect the positive terminal clamp.
- ▶ Attach the cover to the positive terminal.
- ▶ Connect the negative terminal clamp.
- ▶ Close the hood.

Carry out the following work after connecting the battery:

- ▶ Reset the side windows (> page 79).

Installing and removing the additional battery (engine compartment)

Removing the additional battery

- ▶ Disconnect the battery (▷ page 264).
- ▶ Loosen the bolts holding the retainer that prevents the battery from moving around.
- ▶ Remove the battery holder and take out the battery.

Installing the additional battery

- ▶ Insert the battery into the battery case.
- ▶ Insert the battery holder.
- ▶ Tighten the bolts holding the retainer that prevents the battery in the engine compartment from moving around.
- ▶ Connect the battery (▷ page 264).

Disconnecting and connecting the auxiliary battery (base of the driver's seat)

Important safety notes

WARNING

During the charging process, a battery produces hydrogen gas. If a short circuit occurs or sparks are created, the hydrogen gas can ignite. There is a risk of an explosion.

- Make sure that the positive terminal of a connected battery does not come into contact with vehicle parts.
- Never place metal objects or tools on a battery.
- It is important that you observe the described order of the battery terminals when connecting and disconnecting a battery.
- When jump-starting, make sure that the battery poles with identical polarity are connected.

- It is particularly important to observe the described order when connecting and disconnecting the jumper cables.
- Never connect or disconnect the battery terminals while the engine is running.

Disconnecting the auxiliary battery

- ❗ Switch off the engine and remove the key from the ignition lock before you loosen or disconnect the terminal clamps. Otherwise, you could destroy electronic components such as the alternator.

First disconnect the starter battery in the engine compartment.

- ❗ Always disconnect the battery in the order described below. Never swap the terminal clamps. You may otherwise damage the vehicle electronics.

The auxiliary battery is located in the driver's seat base.

- ▶ Switch off all electrical consumers.
- ▶ Switch off the engine and remove the key from the ignition lock.
- ▶ Fold the driver's seat cushion forward.
- ▶ First loosen and remove the negative terminal clamp so that it is no longer in contact with the terminal.
- ▶ Remove the cover from the positive terminal.
- ▶ Loosen and remove the positive terminal clamp.

Reconnecting the auxiliary battery

- ❗ Always connect the battery in the order described below. Never swap the terminal clamps. You may otherwise damage the vehicle electronics.

- ▶ Connect the positive terminal clamp.
- ▶ Attach the cover to the positive terminal.
- ▶ Connect the negative terminal clamp.
- ▶ Fold the driver's seat cushion back.

Installing and removing the auxiliary battery (base of the driver's seat)

Removing the auxiliary battery

- ▶ Disconnect the battery (▷ page 265).
- ▶ Loosen the bolts holding the retainer that prevents the battery from moving around in the base of the driver's seat.
- ▶ Remove the battery holder and take out the battery.

Installing the auxiliary battery

- ▶ Insert the battery into the battery case.
- ▶ Insert the battery holder.
- ▶ Tighten the bolts holding the retainer that prevents the battery from moving around in the base of the driver's seat.
- ▶ Connect the battery (▷ page 265).

Charging

WARNING

During charging and jump-starting, explosive gases can escape from the battery. There is a risk of an explosion.

Particularly avoid fire, open flames, creating sparks and smoking. Ensure there is sufficient ventilation while charging and jump-starting. Do not lean over a battery.

WARNING

Battery acid is caustic. There is a risk of injury. Avoid contact with the skin, eyes or clothing. Do not inhale any battery gases. Do not lean over the battery. Keep children away from batteries. Wash battery acid immediately with water and seek medical attention.

- ❗ Only charge the installed battery with a battery charger that has been tested and approved by the distributor named on the inside of the front cover. This device allows the battery to be charged when it is instal-

led in the vehicle. The vehicle's electronics may otherwise be damaged.

- ▶ Recharge the removed battery. Observe the notes in the operating instructions for your battery charger.
- ▶ Install the battery. Observe the notes on reconnecting the battery.

- i** If batteries are not being used, you should charge them once a month.

It is also possible to charge the starter battery using the jump-starting connection point in the engine compartment (▷ page 278).

Care

- ❗ Dirty battery clamps and battery surfaces cause leak currents which lead to the batteries discharging.

- ❗ Do not use cleaning agents containing fuel. Cleaning agents containing fuel corrode the battery housing.

- ❗ If dirt gets into the battery cell, battery self-discharge will increase and the battery may be damaged.

The following points on battery care must be observed:

- ▶ Regularly check the battery terminals and the fastening of the negative cable to the chassis to ensure that they are firmly seated.
- ▶ Always keep the battery terminals and battery surfaces clean and dry.
- ▶ Lightly grease the undersides of the battery terminals with acid-resistant grease.
- ▶ Only clean the batteries when the caps are screwed on. Otherwise, dirt could get into the battery cells.
- ▶ Unscrew the caps and clean blocked breathers with a suitable tool such as a piece of wire.

If you do not unscrew the caps for cleaning, there is a risk of short circuit.

The breathers in the caps and the cell ventilation tubes must be open. Otherwise, gas cannot escape.

- ▶ Only clean the battery casing with a commercially available cleaning product.

Care

Notes on care

WARNING

If you use openings in the bodywork or detachable parts as steps, you could:

- slip and/or fall
- damage the vehicle and cause yourself to fall.

There is a risk of injury.

Always use secure climbing aids, e.g. a suitable ladder.

- ❗ For cleaning your vehicle, do not use any of the following:

- dry, rough or hard cloths
- abrasive cleaning agents
- solvents
- cleaning agents containing solvents

Do not scrub.

Do not touch the surfaces or protective films with hard objects, e.g. a ring or ice scraper. You could otherwise scratch or damage the surfaces and protective film.

- ❗ Do not park the vehicle for an extended period straight after cleaning it, particularly after having cleaned the wheels with wheel cleaner. Wheel cleaners could cause increased corrosion of the brake discs and brake pads/linings. For this reason, you should drive for a few minutes after cleaning. Braking heats the brake discs and the brake pads/linings, thus drying them. The vehicle can then be parked.

Environmental note

Only clean your vehicle at specially designed wash bays. Dispose of empty containers and used cleaning products in an environmentally responsible manner.

Environmental note

Dispose of empty packaging and cleaning cloths in an environmentally responsible manner.

Regular care of your vehicle is a condition for retaining the quality in the long term.

Use care products and cleaning agents recommended and approved for Sprinter vehicles.

Washing the vehicle and cleaning the paintwork

Automatic car wash

WARNING

Braking efficiency is reduced after washing the vehicle. There is a risk of an accident.

After the vehicle has been washed, brake carefully while paying attention to the traffic conditions until full braking power is restored.

- ❗ Never clean your vehicle in a Touchless Automatic Car Wash as these use special cleaning agents. These cleaning agents can damage the paintwork or plastic parts.

- ❗ Make sure that the automatic car wash is suitable for the size of the vehicle.

Before washing the vehicle in an automatic car wash, fold in the exterior mirrors and remove any additional antennas. Otherwise, the exterior mirror, antenna or the vehicle itself could be damaged.

Make sure that the exterior mirrors are fully folded out again and that any additional antennas are re-installed when you leave the automatic car wash.

! Make sure that:

- the side windows and the roof are completely closed
- the climate control blower is switched off
- the windshield wiper switch is at position **0**

The vehicle could otherwise be damaged.

You can wash the vehicle in an automatic car wash from the very start.

Wash off excess dirt before cleaning the vehicle in an automatic car wash.

After putting the vehicle through an automatic car wash, wipe off wax from:

- the rear view camera lens (▷ page 271)
- the windshield
- the windshield wiper blades

This will prevent smears and reduce wiping noises caused by residue on the windshield.

Washing by hand

In some countries, washing by hand is only allowed at specially equipped washing bays. Observe the legal requirements for each individual country.

- ▶ Do not use hot water and do not wash the vehicle in direct sunlight.
- ▶ Use a soft car sponge.
- ▶ Use a mild cleaning agent, e.g. a car shampoo approved for use with Sprinter vehicles.
- ▶ Thoroughly hose down the vehicle with a gentle jet of water.
- ▶ Do not point the water jet directly towards the air inlets.
- ▶ Use plenty of water and rinse out the sponge frequently.
- ▶ Rinse the vehicle with clean water and dry thoroughly with a chamois.
- ▶ Do not let the cleaning agents dry on the paintwork.

When using the vehicle in winter, remove all traces of road salt deposits carefully and as soon as possible.

High-pressure cleaning equipment

WARNING

The water jet from a circular jet nozzle (dirt blasters) can cause invisible exterior damage to the tires or chassis components. Components damaged in this way may fail unexpectedly. There is a risk of an accident.

Do not use power washers with circular jet nozzles to clean the vehicle. Have damaged tires or chassis components replaced immediately.

! Under no circumstances use power washers in the vehicle interior. The pressurized water and associated spray produced by the power washer could cause extensive damage to the vehicle.

! Observe the minimum distance to be maintained between the nozzle of the power washer and object to be cleaned, as outlined below:

- approximately 2.2 ft (70 cm) when using round-jet nozzles
- approximately 1 ft (30 cm) when using 25° flat-spray jets and dirt blasters

Keep the water jet moving while cleaning. To avoid causing damage, do not point the water jet directly at:

- door joints
- brake hoses
- electrical components
- electrical connections
- seals
- drive train, especially not at the intermediate bearing of the propeller shaft
- rear view camera (camera lens and microphone opening on the bottom)

Keep a minimum distance of 1.6 ft (50 cm).

Cleaning the engine

! Water must not enter intake or ventilation openings. When cleaning with high pressure water or steam cleaners, the spray must not be aimed directly at electrical components or the terminals of electrical lines.

Preserve the engine after the engine has been cleaned. Protect the belt drive system from exposure to the preservative agent.

Also observe the information in the section "Power washer" (> page 268).

Cleaning the paintwork

! Do not affix:

- stickers
 - films
 - magnetic plates or similar items
- to painted surfaces. You could otherwise damage the paintwork.

Scratches, corrosive deposits, areas affected by corrosion and damage caused by inadequate care cannot always be completely repaired. In such cases, visit a qualified specialist workshop.

- ▶ Remove impurities immediately, where possible, whilst avoiding rubbing too hard.
- ▶ Soak insect remains with insect remover and rinse off the treated areas afterwards.
- ▶ Soak bird droppings with water and rinse off the treated areas afterwards.
- ▶ Remove coolant, brake fluid, tree resin, oils, fuels and greases by rubbing gently with a cloth soaked in petroleum ether or lighter fluid.
- ▶ Use tar remover to remove tar stains.
- ▶ Use silicone remover to remove wax.

Cleaning the windows

WARNING

You could become trapped by the windshield wipers if they start moving while cleaning the

windshield or wiper blades. There is a risk of injury.

Always switch off the windshield wipers and the ignition before cleaning the windshield or wiper blades.

- !** Do not fold the windshield wipers away from the windshield unless the hood is closed. Otherwise, you could damage the hood.
- !** Hold the wiper arm securely when folding back. The windshield could be damaged if the wiper arm smacks against it suddenly.
- !** Do not use dry cloths, abrasive products, solvents or cleaning agents containing solvents to clean the inside of the windows. Do not touch the insides of the windows with hard objects, e.g. an ice scraper or ring. There is otherwise a risk of damaging the windows.

Before cleaning the windshield

- ▶ Turn the key to position **0** in the ignition lock or remove it.
- ▶ Fold the windshield wiper arms away from the windshield until you feel them engage. Before switching the ignition on again, fold the windshield wipers back into position.

Cleaning the windows

- ▶ Clean the inside and outside of the windows with a damp cloth and a cleaning agent that is recommended and approved for Sprinter vehicles.

Exterior

Cleaning the wheels

- !** Do not use any acidic or alkaline cleaning agents. They can cause corrosion on the wheel bolts (wheel nuts) or the retainer springs for the wheel-balancing weights.
- !** Do not park the vehicle for an extended period straight after cleaning it, particularly after having cleaned the wheels with wheel

cleaner. Wheel cleaners could cause increased corrosion of the brake discs and brake pads/linings. For this reason, you should drive for a few minutes after cleaning. Braking heats the brake discs and the brake pads/linings, thus drying them. The vehicle can then be parked.

If you clean the wheels with a power washer, observe the safety notes for the power washer (> page 268). You could otherwise damage the tires.

Cleaning the wiper blades

WARNING

You could become trapped by the windshield wipers if they start moving while cleaning the windshield or wiper blades. There is a risk of injury.

Always switch off the windshield wipers and the ignition before cleaning the windshield or wiper blades.

- !** Do not fold the windshield wipers away from the windshield unless the hood is closed. Otherwise, you could damage the hood.
- !** Do not pull the wiper blade. Otherwise, the wiper blade could be damaged.
- !** Do not clean wiper blades too often and do not rub them too hard. Otherwise, the graphite coating could be damaged. This could cause wiper noise.
- !** Hold the wiper arm securely when folding back. The windshield could be damaged if the wiper arm smacks against it suddenly.
- ▶ Turn the key to position **0** in the ignition lock or remove it.
- ▶ Fold the windshield wiper arms away from the windshield until you feel them engage.
- ▶ Carefully clean the wiper blades with a damp cloth.
- ▶ Fold back the wiper arms before switching on the ignition.

Cleaning the exterior lighting

- !** Only use cleaning agents or cleaning cloths which are suitable for plastic light lenses. Unsuitable cleaning agents or cleaning cloths could scratch or damage the plastic light lenses.
- ▶ Clean the plastic covers of the exterior lighting with a damp sponge and a mild cleaning agent, e.g. car shampoo for Sprinter vehicles, or with cleaning cloths.

Cleaning the mirror turn signal

- !** Only use cleaning agents or cleaning cloths that are suitable for plastic lenses. Unsuitable cleaning agents or cleaning cloths could scratch or damage the plastic lenses of the mirror turn signals.
- ▶ Clean the plastic lenses of the mirror turn signals in the exterior mirror housing using a wet sponge and mild cleaning agent, e.g. car shampoo or cleaning cloths.

Cleaning the sensors

- !** Do not use dry, coarse or hard cloths and do not scrub. You will otherwise scratch or damage the sensors.
- If you clean the sensors with a power washer or steam cleaner, observe the information provided by the manufacturer regarding the distance to be maintained between the vehicle and the nozzle of the power washer.



PARKTRONIC sensors (example: front bumper, left side of vehicle)

- ▶ Clean all sensors ① in the front and rear bumpers with water, shampoo and a soft cloth.

Cleaning the rear view camera

! Do not use dry, coarse or hard cloths and do not scrub. Otherwise, you will scratch or damage the lens of the rear-view camera.

If you clean the vehicle with a high-pressure or steam cleaner, maintain a distance of at least 1.650 cm from the rear-view camera. Do not aim directly at the rear-view camera or at the microphone opening on the underside of the rear-view camera. You could otherwise damage the rear-view camera.

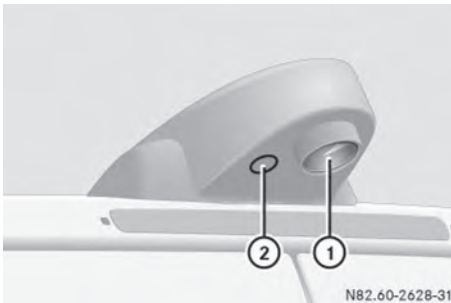

Rear view camera in the middle of the roof above the high-mounted brake lamp

- ① Camera lens
- ② Microphone openings
- ▶ Clean camera lens ① with clear water and a soft cloth.

Make sure that you do not apply any wax to camera lens ① when waxing the vehicle. If necessary, remove the wax using water, shampoo and a soft cloth.

Cleaning the sliding door

- ▶ Remove foreign objects from the vicinity of the contact surfaces and contact pins of the sliding door.
- ▶ Clean the contact surfaces and contact pins with a mild cleaning agent and a soft cloth.

Do not oil or grease the contact plates and contact pins.

Cleaning the electrical step

Clean the electrical step at least once a month. Make sure that no dirt accumulates in the housing or on the step.

- ▶ Extend the electrical step (▷ page 73).
- ▶ Close the sliding door until the door lock engages.
 - The electrical step remains extended for cleaning.
- ▶ Clean the electrical step and the housing with a power washer.
- ▶ After cleaning, spray the step guides on each side with silicone spray when the housing and electrical step are dry. Do not use oil or grease as a lubricant.
- ▶ Retract the electric step.

Cleaning the trailer tow hitch

- !** Do not clean the ball coupling with a power washer. Do not use solvents.
- !** Observe the notes on care in the Operator's Manual for the trailer tow hitch and the ball coupling manufacturer.

You can also have the maintenance work on the ball coupling and the trailer tow hitch carried out by a qualified specialist workshop.

Interior

Cleaning with a power washer

- !** When using liquids to clean the vehicle interior, observe the following points:
 - Under no circumstances use power washers.
 - Make sure that no fluids enter or remain in gaps and cavities.

- Ensure sufficient ventilation when cleaning.
- Make sure that the vehicle interior is completely dry after cleaning.

Cleaning the display

! For cleaning, do not use any of the following:

- alcohol-based thinner or gasoline
- abrasive cleaning agents
- commercially-available household cleaning agents

These may damage the display surface. Do not put pressure on the display surface when cleaning. This could lead to irreparable damage to the display.

- ▶ Switch off the audio equipment and let the display cool down.
- ▶ Clean the display surface with a commercially available microfiber cloth and cleaner for TFT/LCD displays.
- ▶ Dry the display surface using a dry microfiber cloth.

Cleaning the plastic trim

WARNING

Care products and cleaning agents containing solvents cause surfaces in the cockpit to become porous. As a result, plastic parts may come loose in the event of air bag deployment. There is a risk of injury.

Do not use any care products and cleaning agents to clean the cockpit.

! Do not affix the following to plastic surfaces:

- stickers
- films
- scented oil bottles or similar items

You can otherwise damage the plastic.

! Do not allow cosmetics, insect repellent or sunscreen to come into contact with the

plastic trim. This maintains the high-quality look of the surfaces.

- ▶ Wipe the plastic trim and the cockpit with a damp, lint-free cloth, e.g. a microfiber cloth.
- ▶ **Heavy soiling:** use a mild detergent.

Cleaning the steering wheel and selector lever

- ▶ Thoroughly wipe with a damp cloth.

Cleaning the trim elements

! Do not use solvent-based cleaning agents such as tar remover, wheel cleaners, polishes or waxes. There is otherwise a risk of damaging the surface.

- ▶ Wipe the trim elements with a damp, lint-free cloth, e.g. a microfiber cloth.
- ▶ **Heavy soiling:** use care products and cleaning agents recommended and approved for Sprinter vehicles.

Cleaning the seat covers

! Do not use microfiber cloths to clean artificial leather covers. If used often, a microfiber cloth can damage the cover.

! Clean:

- artificial leather covers with a cloth moistened with a solution containing 1% detergent, e.g. dish washing liquid.
- cloth covers with a microfiber cloth moistened with a solution containing 1% detergent, e.g. dish washing liquid. Wipe entire seat sections carefully to avoid leaving visible lines. Leave the seat to dry afterwards. Cleaning results depend on the type of dirt and how long it has been there.

Cleaning the seat belts

WARNING

Seat belts can become severely weakened if bleached or dyed. This could cause the seat belts to tear or fail, for instance, in the event of an accident. This poses an increased risk of injury or fatal injury.

Never bleach or dye the seat belts.

! Do not clean the seat belts using chemical cleaning agents. Do not dry the seat belts by heating at temperatures above 176 °F (80 °C) or in direct sunlight.

Remove any stains or dirt immediately. This will avoid residue or damage.

- ▶ Use clean, lukewarm water and soap solution.

Cleaning the roof trim

- ▶ Use a soft brush or dry shampoo to remove heavy soiling.

Cleaning the curtains

! The curtains must not be washed. Washing could cause the curtains to shrink and lose their fire-retardant properties. Always have the curtains dry-cleaned.

Useful information	276
Where will I find...?	276
Flat tire	278
Jump-starting	278
Tow-starting and towing away	279
Electrical fuses	283

Useful information

This Operator's Manual describes all models as well as standard and optional equipment of your vehicle that were available at the time of going to print. Country-specific variations are possible. Note that your vehicle may not be equipped with all of the described functions. This also applies to systems and functions relevant to safety.

Read the information on qualified specialist workshops (▷ page 26).

Where will I find...?

Vehicle tool kit

General notes

The vehicle tool kit is in the stowage compartment in the footwell on the co-driver's side.

The vehicle tool kit consists of:

- a towing eye
- a screwdriver with Torx, Phillips and slotted bits

If your vehicle is equipped with a spare wheel bracket and a jack, the vehicle tool kit additionally contains:

- a wheel wrench
- a spanner
- a pump lever rod

Stowage compartment in the co-driver's footwell

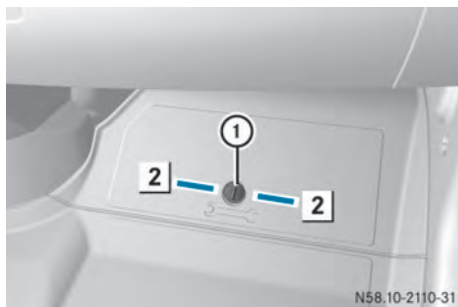

N58.10-2110-31

Unlocking and removing the cover

- ▶ Turn quick-release fastener (1) counter-clockwise or clockwise (2).
- ▶ Slightly raise and pull out the cover.

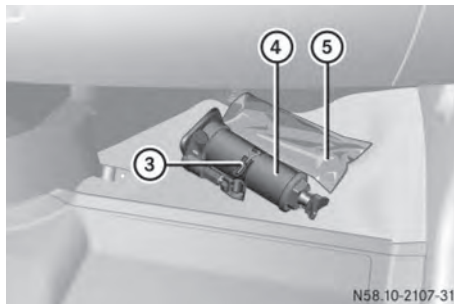

Removing the vehicle tool kit and the jack

- ▶ Remove vehicle tool kit (5).
- ▶ Pull up quick-release lever (3) and unhook the retaining strap of jack (4).
- ▶ Lift jack (4) upwards out of the holder.
- ▶ **i** When stowing away the jack, place it in the holder as shown in the illustration. Make sure that the retaining strap of the jack is hooked in and tensioned.

Inserting and engaging the cover

- ▶ Slide in the cover and fold it down.
- ▶ Press down quick-release fastener (1) until it engages.

Warning triangle and warning lamp

Removing the warning lamp

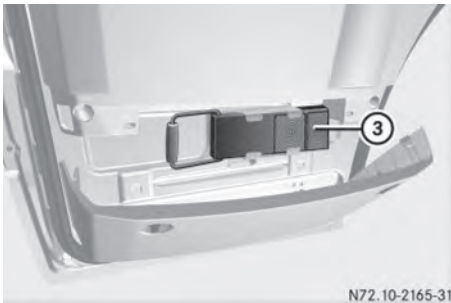
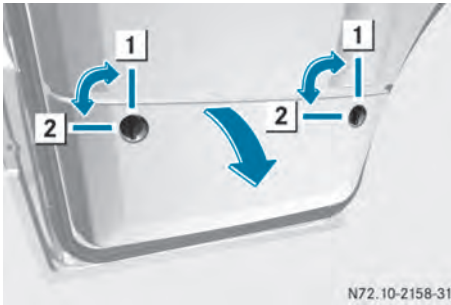

- ▶ Turn the quick-release fasteners to position **2**.
The cover is unlocked.
- ▶ Lift up the cover.
- ▶ Take warning lamp **3** out of the retainer.
- ▶ Fold the cover up and turn the quick-release fasteners to position **1**.
The cover is locked.

Removing the warning triangle

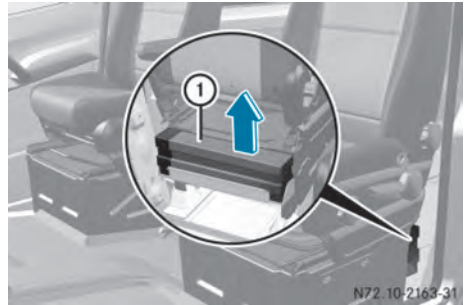

Warning triangles at the back of the driver's seat base

- ▶ Lift warning triangle **1** up and out of the bracket.

First-aid kit

Removing the first-aid kit

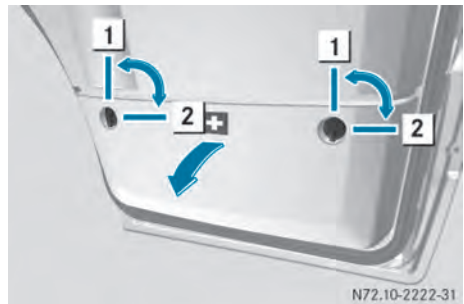

- ▶ Turn the quick-release fasteners to position **2**.
The cover is unlocked.
- ▶ Lift up the cover.

- ▶ Take first-aid kit ③ out of the retainer.
- ▶ Fold the cover up and turn the quick-release fasteners to position ①. The cover is locked.
- ① Check the expiration date on the first-aid kit at least once a year. Replace any expired or missing contents.

Fire extinguisher

Removing the fire extinguisher

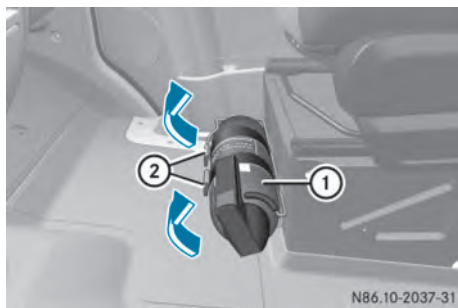

Fire extinguisher at the front of the base of the co-driver's seat

- ▶ Pull tabs ② upwards.
- ▶ Take fire extinguisher ① out of its holder.

- ① Please read the instructions on fire extinguisher ① carefully and familiarize yourself with its operation. Have fire extinguisher ① refilled after each use and checked every one or two years. It may otherwise fail in an emergency. Observe the legal requirements for each individual country.

Flat tire

Information on breakdown assistance in the case of a flat tire can be found in the chapter "Wheels and tires" (> page 307).

Jump-starting

Important safety notes

⚠ WARNING

During charging and jump-starting, explosive gases can escape from the battery. There is a risk of an explosion.

Particularly avoid fire, open flames, creating sparks and smoking. Ensure there is sufficient ventilation while charging and jump-starting. Do not lean over a battery.

⚠ WARNING

Battery acid is caustic. There is a risk of injury. Avoid contact with the skin, eyes or clothing. Do not inhale any battery gases. Do not lean over the battery. Keep children away from batteries. Wash battery acid immediately with water and seek medical attention.

Do not use a rapid charging device to start the vehicle. If your vehicle's battery is discharged, the engine can be jump-started from another vehicle or from a donor battery using jumper cables. For this purpose, the vehicle has a jump-starting connection point in the engine compartment.

The additional battery in the engine compartment is not suitable for jump-starting operations. If your vehicle requires jump-starting, or if you use it to jump-start another vehicle, use the jump-starting connection point in the engine compartment.

When jump-starting, observe the following points:

- The battery is not accessible in all vehicles. If the other vehicle's battery is not accessible, jump-start the vehicle using a donor battery or a jump-starting device.
- Do not start the engine if the battery is frozen. Let the battery thaw first.
- Jump-starting may only be performed from batteries with a nominal voltage of 12 V.

- Only use jumper cables that have a sufficient cross-section and insulated terminal clamps.
- If the battery is fully discharged, attach the battery of another vehicle for a few minutes before attempting to start. This charges the empty battery a little.
- Make sure that the two vehicles do not touch.

Make sure that:

- the jumper cables are not damaged.
- bare parts of the terminal clamps do not come into contact with other metal parts while the jumper cables are connected to the battery.
- the jumper cables cannot come into contact with parts such as the V-belt pulley or the fan. These parts move when the engine is started and while it is running.

i Jumper cables and further information regarding jump starting can be obtained at any qualified specialist workshop.

Before connecting the jumper cables

On vehicles with a battery main switch, check whether the battery main switch is switched on (▷ page 136).

- ▶ Apply the parking brake.
- ▶ Move the selector lever of the automatic transmission to position **P**.
- ▶ Switch off all electrical consumers, e.g. audio equipment, blower.
- ▶ Turn the key to position **0** in the ignition lock and remove it (▷ page 137).
- ▶ Open the hood (▷ page 250).

Tow-starting and towing away

Important safety notes

WARNING

Functions relevant to safety are restricted or no longer available if:

- the engine is not running.
- the brake system or the power steering is malfunctioning.
- there is a malfunction in the voltage supply or the vehicle's electrical system.

If your vehicle is being towed, much more force may be necessary to steer or brake. There is a risk of an accident.

In such cases, use a tow bar. Before towing, make sure that the steering moves freely.

WARNING

You can no longer steer the vehicle if the steering wheel lock has been engaged. There is a risk of an accident.

Always switch off the ignition when towing the vehicle with a tow cable or a tow bar.

WARNING

If the weight of the vehicle to be towed or tow-started is greater than the permissible gross weight of your vehicle:

- the towing eye could detach itself
- the vehicle/trailer combination could roll-over.

There is a risk of an accident.

When towing or tow-starting another vehicle, its weight should not be greater than the permissible gross weight of your vehicle.

Information on your vehicle's gross vehicle weight rating can be found on the vehicle identification plate (▷ page 319).

! Only secure the tow rope or tow bar at the towing eyes. Otherwise, the vehicle could be damaged.

! Observe the following points when towing with a tow rope:

- Secure the tow rope on the same side on both vehicles.
- Ensure that the tow cable is not longer than legally permitted. Mark the tow cable in the middle, e.g. with a white cloth (30 x 30 cm). This will make other road users aware that the vehicle is being towed.
- Only secure the tow cable to the towing eye.
- Observe the brake lamps of the towing vehicle while driving. Always maintain a distance so that the tow rope does not sag.
- Do not use steel cables or chains to tow your vehicle. You could otherwise damage the vehicle.

! Do not use the towing eye for recovery, this could damage the vehicle. If in doubt, recover the vehicle with a crane.

! When towing, pull away slowly and smoothly. If the tractive power is too high, the vehicles could be damaged.

Observe the legal requirements for the relevant country when towing.

It is preferable to have the vehicle transported on a transporter or trailer instead of towing it.

The automatic transmission selector lever must be in the **N** position when towing the vehicle.

The battery must be connected and charged. Otherwise, you:

- cannot turn the key in the ignition lock to position **2**
- cannot move the selector lever to position **N** on vehicles with automatic transmission.

i Switch off the automatic locking feature before the vehicle is towed (▷ page 71). You could otherwise lock yourself out of the vehicle when pushing or towing away the vehicle.

Installing/removing the towing eye

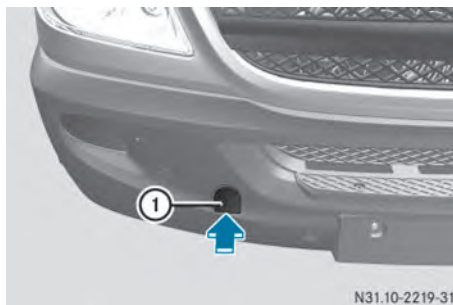

The fixture for the front towing eye is located in the bumper.

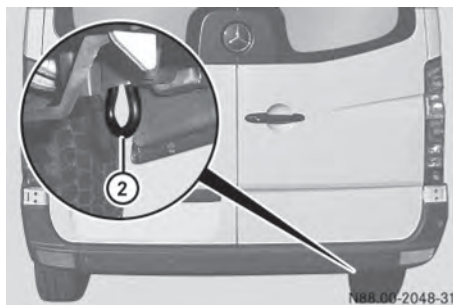

Rear towing eye under the bumper, attached to the chassis

Your vehicle may be equipped with rear towing eye ②. If you tow or tow-start a vehicle, attach the towing device to rear towing eye ②.

If your vehicle is equipped with a trailer tow hitch, attach the towing device to the trailer tow hitch (▷ page 173).

Installing the front towing eye

- ▶ Take the towing eye and screwdriver from the vehicle tool kit (▷ page 276).
- ▶ Press cover ① and remove cover ① from the opening.
You will see the fixture for the towing eye.
- ▶ Screw in the towing eye clockwise to the stop.
- ▶ Insert screwdriver into the towing eye and tighten it.

Removing the front towing eye

- ▶ Remove the screwdriver from the vehicle tool kit.
- ▶ Insert the screwdriver into the towing eye and turn the screwdriver counter-clockwise.
- ▶ Unscrew the towing eye.
- ▶ Insert cover ① with the lug at the bottom and press it in at the top until it engages.
- ▶ Place the towing eye and screwdriver back in the vehicle tool kit.

Towing in the event of malfunctions

With transmission damage

⚠ Always use new bolts when installing the propeller shafts.

ℹ Only have the propeller shafts fitted/removed at a qualified specialist workshop.

If the vehicle has transmission damage, have the propeller shaft removed before towing away.

In the event of damage to the electrical system

If the battery is defective, the automatic transmission will be locked in position **P**. In order to be able to shift the automatic transmission to position **N**, you must provide power to the vehicle's 12 V electrical system in the same way as when jump-starting (▷ page 278).

Have the vehicle transported on a transporter or trailer.

Towing with the front or rear axle raised

General notes

⚠ The ignition must be switched off if the vehicle is being towed with the front or rear

axle raised. Otherwise, ESP® may intervene and damage the brake system.

⚠ Always use new bolts when installing the propeller shafts.

ℹ Only have the propeller shafts fitted/removed at a qualified specialist workshop.

Observe the following before towing a vehicle with a raised front or rear axle:

- the information on towing in the event of malfunctions (▷ page 281) and
- the important safety notes (▷ page 279).

If the front axle is damaged, raise the vehicle at the front axle and if the rear axle is damaged, raise the vehicle at the rear axle.

Towing

If the front axle is raised, the vehicle may be towed a maximum of 30 miles (50 km). For a towing distance of over 30 miles (50 km), you must remove the propeller shafts to the driven axles.

- ▶ Turn the key to position **2** in the ignition lock.
- ▶ Depress the brake pedal and keep it depressed.
- ▶ Shift the automatic transmission to position **N**.
- ▶ Release the brake pedal.
- ▶ Release the parking brake.
- ▶ Turn the key to position **1** in the ignition lock and leave it in this position.
- ▶ Switch on the hazard warning lamps (▷ page 96).
- ▶ If the front axle is raised, do not exceed the towing speed of 30 mph (50 km/h) and the towing distance of 30 miles (50 km).



Towing the vehicle with both axles on the ground

Important safety notes

WARNING

You can no longer steer the vehicle if the steering wheel lock has been engaged. There is a risk of an accident.

Always switch off the ignition when towing the vehicle with a tow cable or a tow bar.

-  Do not exceed a towing speed of 31 mph (50 km/h). You could otherwise damage the transmission.
-  Always use new bolts when installing the propeller shafts.
-  Only have the propeller shafts fitted/removed at a qualified specialist workshop.

Before towing the vehicle, observe the following:

- the information on towing in the event of malfunctions (▷ page 281) and
- the important safety notes (▷ page 279).

Towing

You may only tow the vehicle a maximum distance of 30 miles (50 km). For a towing distance of over 30 miles (50 km), you must remove the propeller shafts to the driven axles.

- ▶ Turn the key to position **2** in the ignition lock.
- ▶ Depress the brake pedal and keep it depressed.
- ▶ Shift the automatic transmission to position **N**.
- ▶ Release the brake pedal.
- ▶ Release the parking brake.
- ▶ Leave the key in position **2** in the ignition lock.

- ▶ Switch on the hazard warning lamps (▷ page 96).
- ▶ Do not exceed the towing speed of 30 mph (50 km/h) and the towing distance of 30 miles (50 km).

Recovering a vehicle that is stuck

-  When recovering a vehicle that has become stuck, pull it as smoothly and evenly as possible. Excessive tractive power could damage the vehicles.

If the drive wheels get trapped on loose or muddy ground, recover the vehicle with the utmost care. This is especially the case if the vehicle is laden.

Never attempt to recover a vehicle with a trailer attached.

Pull out the vehicle backwards, if possible, using the tracks it made when it became stuck.

Transporting the vehicle

-  You may only secure the vehicle by the wheels, not by parts of the vehicle such as axle or steering components. Otherwise, the vehicle could be damaged.

Tow-starting (emergency engine starting)

Vehicles with automatic transmission

-  Vehicles with automatic transmission must not be tow-started. You could otherwise damage the automatic transmission.

Information on "Jump-starting" can be found at the beginning of the "Breakdown assistance" section (▷ page 278).

Electrical fuses

WARNING

If you manipulate or bridge a faulty fuse or if you replace it with a fuse with a higher amperage, the electric cables could be overloaded. This could result in a fire. There is a risk of an accident and injury.

Always replace faulty fuses with the specified new fuses having the correct amperage.

- !** Only use fuses that have been approved for Sprinter vehicles and that have the required fuse rating for the systems concerned. Components or systems could otherwise be damaged.

The fuses in your vehicle switch off defective power circuits. If a fuse blows, all the components on the circuit and their functions will cease to operate.

Blown fuses must be replaced with fuses of the same rating, which you can recognize by the color and fuse rating.

Observe the information about fuse rating in the fuse allocation chart.

The fuse allocation chart and other information on the fuses can be found in the "Fuse allocation chart" supplement.

You can obtain advice from a qualified specialist workshop.

Useful information	286
Important safety notes	286
Operation	286
Operation in winter	288
Tire pressure	290
Loading the vehicle	298
What you should know about wheels and tires	301
Flat tire	307
Changing wheels	307
Wheel and tire combination	313
Spare wheel	313

Useful information

This Operator's Manual describes all models as well as standard and optional equipment of your vehicle that were available at the time of going to print. Country-specific variations are possible. Note that your vehicle may not be equipped with all of the described functions. This also applies to systems and functions relevant to safety.

Read the information on qualified specialist workshops (▷ page 26).

Important safety notes

Warning

A flat tire severely impairs the driving, steering and braking characteristics of the vehicle. There is a risk of an accident.

do not drive with a flat tire. Immediately replace the flat tire with your spare wheel, or consult a qualified specialist workshop.

WARNING

If wheels and tires of the wrong size are used, the wheel brakes or suspension components may be damaged. There is a risk of an accident.

Always replace wheels and tires with those that fulfill the specifications of the original part.

When replacing wheels, make sure to use the correct:

- designation
- model

When replacing tires, make sure to use the correct:

- designation
- manufacturer
- model

Accessories that are not approved for your vehicle or are not being used correctly can impair operating safety.

Before purchasing and using non-approved accessories, visit a qualified specialist workshop and inquire about:

- suitability
- legal stipulations
- factory recommendations

Contact an authorized Sprinter dealer if you require information on tested and recommended wheels and tires for summer and winter driving. Advice on purchasing and caring for tires is also available there.

Information on tire and wheel dimensions and types as well as the recommended tire pressure for your vehicle can be found in the "Tire pressure" section (▷ page 297).

This data can also be found on the Tire and Loading Information placard on the B-pillar.

Modifications to the brake system or wheels are not permitted. The use of wheel spacers or brake dust shields is not permitted. This invalidates the general operating permit for the vehicle.

 Further information on wheels and tires can be obtained at any qualified specialist workshop.

Operation

Information for a journey

If the vehicle is heavily laden, check the tire pressures, and correct them, if necessary.

While driving, pay attention to vibrations, noises and unusual handling characteristics, e.g. pulling to one side. This may indicate that the wheels or tires are damaged. If you suspect that a tire is defective, reduce your speed immediately. Stop the vehicle as soon as possible to check the wheels and tires for damage. Hidden tire damage could also be causing the unusual handling characteristics. If you find no signs of damage, have the tires and wheels checked at a qualified specialist workshop.

When parking your vehicle, make sure that the tires do not get deformed by the curb or other obstacles. If it is necessary to drive over curbs, speed humps or similar elevations, try to do so slowly and not at a sharp angle. Otherwise, the tires, particularly the sidewalls, can get damaged.

Regular wheel and tire checks

WARNING

Damaged tires can cause tire inflation pressure loss. As a result, you could lose control of your vehicle. There is a risk of accident.

Check the tires regularly for signs of damage and replace any damaged tires immediately.

Check the wheels and tires of your vehicle for damage regularly, i.e. at least every two weeks, as well as after driving off-road or on rough roads. Damaged wheels can cause a loss of tire pressure. Pay particular attention to damage such as:

- cuts in the tires
- punctures
- tears in the tires
- bulges on tires
- deformation or severe corrosion on wheels

Regularly check the tire tread depth and the condition of the tread across the whole width of the tire (▷ page 287). If necessary, turn the front wheels to full lock in order to inspect the inner side of the tire surface.

All wheels must have a valve cap to protect the valve against dirt and moisture. Do not install anything onto the valve other than the standard valve cap or other valve caps approved for your vehicle by dealers listed on the inside of the front cover. Do not install any other valve caps or systems, e.g. tire pressure monitor systems.

Regularly check the pressure of all the tires, particularly prior to long trips. Adjust the tire pressure if necessary (▷ page 290).

The service life of tires depends on various factors, including the following:

- driving style
- tire pressure
- mileage

Tire tread

WARNING

Insufficient tire tread will reduce tire traction. The tire is no longer able to dissipate water. This means that on wet road surfaces, the risk of hydroplaning increases, in particular where speed is not adapted to suit the driving conditions. There is a risk of accident.

If the tire pressure is too high or too low, tires may exhibit different levels of wear at different locations on the tire tread. Thus, you should regularly check the tread depth and the condition of the tread across the entire width of all tires.

Minimum tire tread depth for:

- Summer tires: $\frac{1}{8}$ in (3 mm)
- M+S tires: $\frac{1}{6}$ in (4 mm)

For safety reasons, replace the tires before the legally prescribed limit for the minimum tire tread depth is reached.

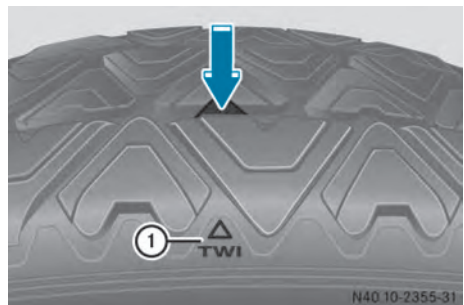

Bar marking  for tread wear is integrated into the tire tread.

Tread wear indicators (TWIs) are required by law. Six indicators are positioned over the tire tread. They are visible once the tread depth is approximately $\frac{1}{16}$ in (1.6 mm). If this is the

case, the tire is so worn that it must be replaced.

Selecting, mounting and renewing tires

- Only mount tires and wheels of the same type and make.
- Only mount tires of the correct size onto the wheels.
- Break in new tires at moderate speeds for the first 65 miles (100 km).
- Do not drive with tires which have too little tread depth, as this significantly reduces the traction on wet roads (hydroplaning).
- Replace the tires after 6 years at the latest, regardless of wear. This also applies to the spare wheel.

Operation in winter

General notes

Have your vehicle winterproofed at a qualified specialist workshop at the onset of winter.

Prior to the onset of winter, ensure that snow chains are stowed in the vehicle (▷ page 289).

Observe the notes in the "Changing a wheel" section (▷ page 307).

Driving with summer tires

At temperatures below 45 °F (+7 °C), summer tires lose elasticity and therefore traction and braking power. Change the tires on your vehicle to M+S tire. Using summer tires at very cold temperatures could cause tears to form, thereby damaging the tires permanently. We cannot accept responsibility for this type of damage.

M+S tires

WARNING

Wheel and tire dimensions as well as the type of tire can vary between the spare wheel and the wheel to be replaced. When the spare wheel is mounted, driving characteristics may be severely affected. There is a risk of an accident.

In order to reduce risks:

- you should therefore adapt your driving style and drive carefully.
- never mount more than one spare wheel that differs from the wheel to be replaced.
- only use a spare wheel that differs from the wheel to be replaced for a short time.
- do not deactivate ESP®.
- have a spare wheel that differs from the wheel that has been changed replaced at the nearest qualified specialist workshop. You must observe the correct wheel and tire dimensions as well as the wheel type.

WARNING

M+S tires with a tire tread depth of less than 1/8 in (4 mm) are not suitable for use in winter and do not provide sufficient traction. There is a risk of an accident.

M+S tires with a tread depth of less than 1/8 in (4 mm) must be replaced immediately.

At temperatures below 45 °F (+7 °C), use winter tires or all-season tires. Both types of tire are identified by the M+S marking.

Only winter tires bearing the  snowflake symbol in addition to the M+S marking provide the best possible grip in wintry road conditions.

Only these tires will allow driving safety systems such as ABS and ESP® to function optimally in winter. These tires have been developed specifically for driving in snow.

For safe driving, use M+S tires of the same make and tread pattern on all wheels.

Always observe the maximum permissible speed specified for the M+S tires you have mounted.

If you mount M+S tires that have a lower maximum permissible speed than that of the vehicle, affix a corresponding warning label in the driver's field of vision. You can obtain this at a qualified specialist workshop.

Once you have mounted the winter tires:

- ▶ Check the tire pressure (▷ page 290).
- ▶ Reactivate the tire pressure monitor* (▷ page 295).

Snow chains

WARNING

If you drive too fast with snow chains mounted, they may snap. As a result, you could injure others and damage the vehicle. There is a risk of an accident.

Observe the maximum permissible speed for operation with snow chains.

When driving with snow chains fitted, do not exceed the maximum permissible speed of 30 mph (50 km/h). Observe the country-specific laws and regulations for operation with snow chains.

! Check the snow chains for damage before mounting them. Damaged or worn snow chains may snap and damage the following components:

- wheel
- wheel housing
- wheel suspension

For this reason, you must use only snow chains that are free of defects. Observe the manufacturer's mounting instructions.

! **Vehicles with steel wheels:** if you mount snow chains on steel wheels, you may damage the hub caps. Remove the hub caps from the relevant wheels before mounting the snow chains.

Snow chains increase traction on roads in wintry conditions.

For reasons of safety we only recommend using snow chains or traction aids that are approved for the Sprinter. The snow chains or traction aids must be of class U or meet the SAE type U specification. Information on snow chains is available at any qualified specialist workshop.

When mounting snow chains, please bear the following points in mind:

- Snow chains cannot be mounted on all wheel/tire combinations. When mounting the snow chains, note the permissible tire and snow chain dimensions.
- Mount snow chains only in pairs and only to the rear wheels. On vehicles with twin tires, mount the snow chains to the outer wheels. Observe the manufacturer's mounting instructions.
- Only use snow chains when the road is covered by a layer of snow. Remove the snow chains as soon as possible when you come to a road that is not snow-covered.
- The use of snow chains may be restricted by local regulations. Observe the appropriate regulations before mounting snow chains.
- When driving with snow chains fitted, do not exceed the maximum permissible speed of 30 mph (50 km/h).
- Check the tension of the chains after a distance of approximately 0.5 miles (1.0 km).

You can deactivate ASR (▷ page 60) when pulling away with snow chains mounted. This allows the wheels to spin in a controlled manner, achieving an increased driving force (cutting action).

* optional

Tire pressure

Tire pressure specifications

Important safety notes

WARNING

Underinflated or overinflated tires pose the following risks:

- the tires may burst, especially as the load and vehicle speed increase.
- the tires may wear excessively and/or unevenly, which may greatly impair tire traction.
- the driving characteristics, as well as steering and braking, may be greatly impaired.

There is a risk of an accident.

Follow recommended tire inflation pressures and check the pressure of all the tires including the spare wheel:

- monthly, at least
- if the load changes
- before beginning a long journey
- under different operating conditions, e.g. off-road driving

If necessary, correct the tire pressure.

 The specifications shown on the sample Tire and Loading Information placard and tire pressure table are examples. Tire pressure data are vehicle-specific and may deviate from the data illustrated here. The tire pressure data applicable to your vehicle can be found on the Tire & Loading Information placard or tire pressure plate of your vehicle.

Environmental note

Check the tire pressure regularly, at least every 14 days.

General notes

You will find information on tire pressure for the vehicle's factory-mounted tires on the plates described here.

You will find a table of recommended tire pressure on the Tire and Loading Information placard⁵ or on the tire pressure table on the B-pillar on the driver's side of the vehicle.

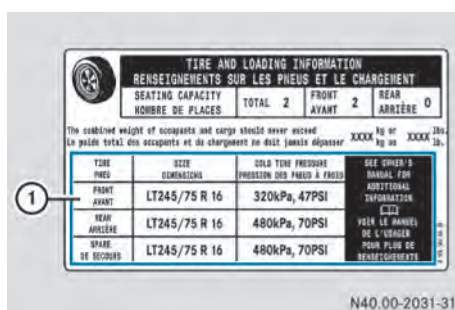

Further information on tire pressure can be obtained at a qualified specialist workshop.

Tire and Loading Information placard



Tire and Loading Information placard⁵

The Tire and Loading Information placard is on the B-pillar on the driver's side of the vehicle (▷ page 298).

The Tire and Loading Information placard contains recommended tire pressures  for cold tires. Recommended tire pressures  are valid for the maximum permissible load and up to the maximum permissible speed of the vehicle.

⁵ Only for vehicles with a gross vehicle weight of less than 10,000 lbs (4,536 kg).

Tire pressure plate

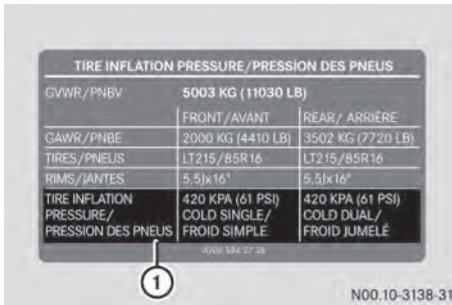

TIRE INFLATION PRESSURE/PRESSION DES PNEUS		
GVWR/PNEU	5003 KG (11030 LB)	
	FRONT / AVANT	REAR / ARRIERE
GAWR/PNEU	2000 KG (4410 LB)	3502 KG (7720 LB)
TIRES/PNEUS	LT215/85R16	LT215/85R16
RIMS/JANTES	5.5Jx16 ⁶	5.5Jx16 ⁶
TIRE INFLATION PRESSURE/PRESSION DES PNEUS	420 KPA (61 PSI) COLD SINGLE/ FROID SIMPLE	420 KPA (61 PSI) COLD DUAL/ FROID JUMELÉ

N00.10-3138-31

Tire pressure plate

The tire pressure table is located on the B-pillar on the driver's side of the vehicle (▷ page 298).

The tire pressure table contains recommended tire pressures ① for cold tires. Recommended tire pressures ① apply to the maximum permissible load and up to the maximum permissible speed of the vehicle.

Important notes on tire pressure

WARNING

If the tire pressure drops repeatedly, the wheel, valve or tire may be damaged. Tire pressure that is too low may result in a tire blow-out. There is a risk of an accident.

- Check the tire for foreign objects.
- Check whether the wheel is losing air or the valve is leaking.

If you are unable to rectify the damage, contact a qualified specialist workshop.

Use a suitable pressure gauge to check the tire pressure. The outer appearance of a tire does not permit any reliable conclusion about the tire pressure. On vehicles equipped with the electronic tire pressure monitor, the tire pressure can be checked using the on-board computer.

The tire temperature and pressure increase when the vehicle is in motion. This is dependent on the driving speed and the load.

Therefore, you should only correct tire pressure when the tires are cold.

The tires are cold:

- if the vehicle has been parked for at least three hours without direct sunlight on the tires, and
- if the vehicle has not been driven further than 1 mile (1.6 km)

Tire temperature changes depending on the ambient temperature, driving speed and tire load. If the tire temperature changes by 18 °F (10 °C), the tire pressure changes by approximately 10 kPa (0.1 bar/1.5 psi). Take this into account when checking the pressure of warm tires. Only correct the tire pressure if it is too low for the current operating conditions. If you check the tire pressure when the tires are warm, it results in a higher value than when the tires are cold. This is normal. Do not under any circumstances release the air in order to adjust the pressure to the prescribed value for cold tires. The tire pressure would otherwise be too low.

Observe the recommended tire pressures for cold tires:

- on the Tire and Loading Information placard⁶ on the B-pillar on the driver's side or
- on the tire pressure table on the B-pillar on the driver's side of the vehicle

Underinflated or overinflated tires

Underinflated tires:

WARNING

Tires with pressure that is too low can overheat and burst as a consequence. In addition, they also suffer from excessive and/or irregular wear, which can severely impair the brak-

⁶ Only for vehicles with a gross weight of less than 10,000 lbs (4,536 kg).

ing properties and the driving characteristics. There is a risk of an accident.

Avoid tire pressures that are too low in all the tires, including the spare wheel.

Underinflated tires can:

- fail from being overheated
- adversely affect handling
- wear excessively and/or unevenly
- have an adverse effect on fuel consumption

Overinflated tires

WARNING

Tires with excessively high pressure can burst because they are damaged more easily by road debris, potholes etc. In addition, they also suffer from irregular wear, which can severely impair the braking properties and the driving characteristics. There is a risk of an accident.

Avoid tire pressures that are too high in all the tires, including the spare wheel.

Overinflated tires can:

- increase the braking distance
- adversely affect handling
- wear excessively and/or unevenly
- adversely affect ride comfort
- be more susceptible to damage

Maximum tire pressures



- ① Maximum permitted tire pressure (example)

Never exceed the maximum permissible tire inflation pressure. When adjusting the tire pressures always observe the recommended tire pressure for your vehicle (▷ page 290).

-  The actual values for tires are specific to each vehicle and may deviate from the values in the illustration.

Tire valve (snap-in valve)

WARNING

Tire valve that are not approved for your vehicle by the distributor named on the inside cover page may result in a loss of tire pressure. This may affect road safety. There is a risk of an accident.

Only use tire valve that are approved for your vehicle by the distributor named on the inside cover page. Always make sure you have the correct tire valve type for the tires on your vehicle.

-  Do not screw additional weights (check valves, etc.) onto the tire valves. The electronic components could thus be damaged.

Only for vehicles without a tire pressure monitor:

For safety reasons, we recommend that you only use tire valves that have been tested for use on your vehicle, e.g. those manufactured by Wonder:

- type TR 600 for the vehicle types 2500
- type TR 418 for the vehicle types 3500

Checking the tire pressure manually

In order to determine and adjust the tire pressures, proceed as follows:

- ▶ Remove the valve cap of the tire you wish to check.
- ▶ Press the tire pressure gauge securely onto the valve.
- ▶ Read the tire pressure and compare it with the recommended value on the loading

information table or the tire pressure table (▷ page 290).

- ▶ If the tire pressure is too low, increase it to the recommended value.
- ▶ If the tire pressure is too high, release air by pressing down the metal pin in the valve. Use the tip of a pen, for example. Then, check the tire pressure again using the tire pressure gauge.
- ▶ Screw the valve cap onto the valve.
- ▶ Repeat the steps for the other tires.

Tire pressure monitor

Important safety notes

WARNING

Each tire, including the spare (if provided), should be checked at least once a month when cold and inflated to the pressure recommended by the vehicle manufacturer on the Tire and Loading Information placard on the driver's door B-pillar or the tire pressure label on the inside of the fuel filler flap. If your vehicle has tires of a different size than the size indicated on the Tire and Loading Information placard or the tire pressure label, you should determine the proper tire pressure for those tires.

As an added safety feature, your vehicle has been equipped with a tire pressure monitoring system (TPMS) that illuminates a low tire pressure telltale when one or more of your tires are significantly underinflated. Accordingly, when the low tire pressure telltale illuminates, you should stop and check your tires as soon as possible, and inflate them to the proper pressure. Driving on a significantly underinflated tire causes the tire to overheat and can lead to tire failure. Underinflation also reduces fuel efficiency and tire tread life, and may affect the vehicle's handling and stopping ability.

Please note that the TPMS is not a substitute for proper tire maintenance, and it is the driver's responsibility to maintain correct tire

pressure, even if underinflation has not reached the level to trigger illumination of the TPMS low tire pressure telltale.

USA only:

Your vehicle has also been equipped with a TPMS malfunction indicator to indicate if the system is not operating properly. The TPMS malfunction indicator is combined with the low tire pressure telltale. When the system detects a malfunction, the warning lamp will flash for approximately a minute and then remain continuously illuminated. This sequence will be repeated every time the vehicle is started as long as the malfunction exists.

When the malfunction indicator is illuminated, the system may not be able to detect or signal low tire pressure as intended. TPMS malfunctions may occur for a variety of reasons, including the mounting of incompatible replacement or alternate tires or wheels on the vehicle that prevent the TPMS from functioning properly. Always check the TPMS malfunction telltale after replacing one or more tires or wheels on your vehicle to ensure that the replacement or alternate tires and wheels allow the TPMS to continue to function properly.

Vehicles with a tire pressure monitor are equipped with sensors in the wheels that monitor the tire pressure of all four tires. The tire pressure monitor monitors the pressure in all four tires; you set this pressure when you activate the tire pressure monitor. The tire pressure monitor warns you when the pressure drops in one or more of the tires. The tire pressure monitor only functions if the corresponding sensors are installed to all wheels.



You should always adjust the tire pressure according to the vehicle load. Restart the tire pressure monitor if you change the tire pressure.

The tire pressure monitor does not warn you if a tire pressure is incorrect. Observe the



notes on the recommended tire pressure (▷ page 290).

The tire pressure monitor is not able to warn you of a sudden loss of pressure, e.g. following penetration by a foreign object. In this event, brake the vehicle until it comes to a standstill. Do not carry out any sudden steering maneuvers.

The tire pressure monitor has a yellow  warning lamp in the instrument cluster for indicating pressure loss/malfunctions (USA) or pressure loss (Canada). Depending on how the warning lamp flashes or lights up, an underinflated tire or a malfunction in the tire pressure monitor is displayed:

- if the  warning lamp is lit continuously, the tire pressure on one or more tires is significantly too low. The tire pressure monitor is not malfunctioning.
- USA only: if the  warning lamp flashes for 60 seconds and then remains lit constantly, the tire pressure monitor is malfunctioning.

Only vehicles with steering wheel buttons: the on-board computer displays information on tire pressure. After a few minutes of driving, the current tire pressure of each tire is shown in the on-board computer.

USA only: if the tire pressure monitor is malfunctioning, it may be more than 10 minutes before the malfunction is shown. The  tire pressure warning lamp flashes for 60 seconds and then remains lit. When the malfunction has been rectified, the  tire pressure warning lamp goes out after a few minutes of driving.

The tire pressure values indicated by the on-board computer may differ from those measured at a gas station with a pressure gauge. The tire pressures shown by the on-board computer refer to those measured at sea level. At high altitudes, the tire pressure value indicated by a pressure gauge are higher than those shown by the on-board computer. In this case, do not reduce the tire pressures.





If radio transmitting equipment (e.g. wireless headphones, two-way radios) is operated inside the vehicle or in the vicinity of the vehicle, this can interfere with the operation of the tire pressure monitor.

Checking the tire pressure electronically (vehicles with steering wheel buttons)



Tire pressure display

Using the steering wheel buttons

- ▶ Turn the key to position **2** in the ignition lock.
- ▶ Press the  or  button repeatedly until the standard display is shown (▷ page 189).
- ▶ Press the  or  button repeatedly until the current pressure of the individual tires is shown in the display.

If the vehicle is parked for longer than 20 minutes or you then drive at less than 18 mph (30 km/h), the **Tire pres. displayed after driving for several minutes** message appears.

- ❗ The tire pressure value shown in the display may differ from those measured at a gas station using a pressure gauge. The on-board computer will generally give you a more exact value.

Tire pressure loss warning system

Vehicles with steering wheel buttons

If the tire pressure monitor detects a significant pressure loss on one or more tires, the on-board computer displays a warning message. The  tire pressure loss warning

lamp in the instrument cluster (▷ page 229) lights up.

The tire pressure is shown in 2 red rectangles. The pressure of the tire concerned is shown in one of the two rectangles (▷ page 199). Additionally, a warning tone sounds.

Each tire that is affected by a significant loss of pressure is highlighted in the pressure display.

Restarting the tire pressure monitor

When you restart the tire pressure monitor, the currently set tire pressure are taken as reference values for monitoring.

In most cases, the tire pressure monitor detects the new reference values automatically, e.g. after you have:

- changed the tire pressure
- mounted
- mounted new wheels or tires

However, you can also define reference values manually as described here.

Before restarting the tire pressure monitor:

- ▶ Set the tire pressure to the value recommended on the Tire and Loading Information placard or the tire pressure table on the B-pillar on the driver's side (▷ page 290).
Observe the notes on tire pressure when doing so (▷ page 290).
- ▶ Make sure that the tire pressure is correct on all four wheels.

Restarting the tire pressure monitor (vehicles without steering wheel buttons):





- ▶ Turn the key to position **2** in the ignition lock.
- ▶ Press the **(M)** menu button on the instrument cluster repeatedly until the display shows the following message:
+CAL- TPMS
- ▶ Press the **(+)** button on the instrument cluster.
The display shows:
OK TPMS

The tire pressure monitor activation process has begun. The tire pressures measured for the individual wheels are stored as the new reference values, provided that the tire pressure monitor considers them to be plausible.

If you wish to cancel the restart:

- ▶ Press the **(-)** button or the **(M)** menu button on the instrument cluster.
The activation process is canceled automatically if 30 seconds elapse without input.

Restarting the tire pressure monitor (vehicles with steering wheel buttons):

- ▶ Turn the key to position **2** in the ignition lock.
- ▶ Press the  or  button on the steering wheel repeatedly until the standard display is shown (▷ page 189).
- ▶ Press the  or  button on the steering wheel repeatedly until the current pressure of the individual tires is displayed or the display shows the following message:
Tire pres. displayed after driving for several minutes
- ▶ Press the **(0)** reset button on the instrument cluster.
The display shows the following message:

Monitor current tire pressure?

- ▶ Press the button on the steering wheel.

The display shows the following message:

Tire pres. monitor reactivated

The tire pressure monitor activation process has begun. The tire pressures measured for the individual wheels are stored as the new reference values, provided that the tire pressure monitor considers them to be plausible.

If you wish to cancel the restart:

- ▶ Press the button on the steering wheel.

Tire pressure table

Front axle tire pressure values: the following tire pressure values only apply to vehicles with a permissible front axle load of 3970 lbs (1801 kg), 4080 lbs (1851 kg) or 4410 lbs (2000 kg).

Tires/disc wheel	Front axle load		
	3970 lbs (1801 kg)	4080 lbs (1851 kg)	4410 lbs (2000 kg)
LT 215/85 R 16 115/ 112N 5.5Jx16 Half distance between centers: 4.82 in (122.5 mm)	—	380 kPa (3.8 bar/55 psi)	420 kPa (4.2 bar/61 psi)
LT 215/85 R 16 115/112Q 5.5Jx16 Half distance between centers: 4.82 in (122.5 mm)	—	380 kPa (3.8 bar/55 psi)	420 kPa (4.2 bar/61 psi)
LT 245/75 R 16 120/116N 6.5J x 16 Wheel offset: 2.13 in (54 mm)	320 kPa (3.2 bar/47 psi)	—	—

Rear axle tire pressure values: the following tire pressure values only apply to vehicles with a permissible rear axle load of 5360 lbs (2431 kg), 7060 lbs (3202 kg) or 7720 lbs (3502 kg).

Tires/disc wheel	Rear axle load		
	5360 lbs (2431 kg)	7060 lbs (3202 kg)	7720 lbs (3502 kg)
LT 215/85 R 16 115/ 112N 5.5Jx16 Half distance between centers: 4.82 in (122.5 mm)	—	380 kPa (3.8 bar/55 psi)	420 kPa (4.2 bar/61 psi)
LT 215/85 R 16 115/112Q 5.5Jx16 Half distance between centers: 4.82 in (122.5 mm)	—	380 kPa (3.8 bar/55 psi)	420 kPa (4.2 bar/61 psi)
LT 245/75 R 16 120/116N 6.5J x 16 Wheel offset: 2.13 in (54 mm)	480 kPa (4.8 bar/70 psi)	—	—

Loading the vehicle

Instruction labels for tires and loads

WARNING

Overloaded tires can overheat, causing a blowout. Overloaded tires can also impair the steering and driving characteristics and lead to brake failure. There is a risk of accident.

Observe the load rating of the tires. The load rating must be at least half of the GAWR of your vehicle. Never overload the tires by exceeding the maximum load.



The Tire and Loading Information placard on the driver's door B-pillar

Two instruction labels on your vehicle show the maximum possible load.

- 1) Only for vehicles with a gross weight of less than 10,000 lbs (4,536 kg):

Tire and Loading Information placard ① is on the B-pillar on the driver's side. Tire and Loading Information placard ① shows the permissible number of occupants and the maximum permissible load of the vehicle. It also contains details of the tire sizes and corresponding pressures for tires mounted at the factory.

- 2) The vehicle identification plate is located on the base of the driver's seat. The vehicle identification plate informs you of the gross vehicle weight rating. It is made up of the vehicle weight, all vehicle occupants, the fuel and the cargo. You can also find information about the maximum

Gross Axle Weight Rating on the front and rear axle.

The maximum gross axle weight rating is the maximum weight that can be carried by one axle (front or rear axle). Do not exceed the maximum gross vehicle weight or the maximum gross axle weight rating for the front or rear axle.

Tire and Loading Information placard

General notes

Only vehicles with a gross weight of less than 10,000 lbs (4,536 kg) have a Tire and Loading Information placard on the B-pillar on the driver's side.

Maximum permissible gross vehicle weight rating

TIRE AND LOADING INFORMATION RENSEIGNEMENTS SUR LES PNEUS ET LE CHARGEMENT					
SEATING CAPACITY NOMBRE DE PLACES		TOTAL	FRONT AVANT	REAR ARRIÈRE	
TOTAL 2		2	2	0	
*The combined weight of occupants and cargo should never exceed XXXX kg or XXXX lbs. Le poids total des occupants et de chargement ne doit jamais dépasser XXXX kg ou XXXX lbs.					
TIRE PNEU	SIZE DIMENSION	COLD TIRE PRESSURE PRESSION DES PNEUS À FROID		SEE OWNER'S MANUAL FOR ADDITIONAL INFORMATION VOIR LE MANUEL DE L'UTILISATEUR POUR PLUS DE RENSEIGNEMENTS	
FRONT AVANT	LT245/75 R 16	320kPa, 47PSI			
REAR ARRIÈRE	LT245/75 R 16	480kPa, 70PSI			
SPARE LE SECOURS	LT245/75 R 16	480kPa, 70PSI			

N40.00-2030-31

- ① Maximum number of seats
 - ② Maximum permissible gross vehicle weight rating
- Specification for maximum gross vehicle weight ② is listed in the Tire and Loading Information placard: "The gross weight of occupants and luggage must not exceed XXX kilograms or XXX lbs."

The gross weight of all vehicle occupants, cargo, luggage and trailer load/noseweight (if applicable) must not exceed the specified value.

- i** The details on the Tire and Loading Information placard illustration are only an

example. The maximum permissible gross vehicle weight rating is vehicle-specific and may differ from that which is illustrated. You can find the valid maximum permissible gross vehicle weight rating for your vehicle on the Tire and Loading Information placard.

Number of seats

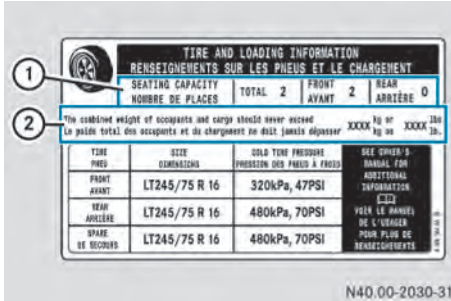

- ① Maximum number of seats
- ② Maximum permissible gross vehicle weight rating

Maximum number of seats ① determines the maximum number of occupants allowed to travel in the vehicle. This information can be found on the Tire and Loading Information placard.

i The details on the Tire and Loading Information placard illustration are only an example. The number of seats is vehicle-specific and can differ from the details shown. The number of seats in your vehicle can be found on the Tire and Loading Information placard.

Determining the maximum load

Individual steps

The following steps have been developed as required of all manufacturers under Title 49, Code of U.S. Federal Regulations, Part 575 in accordance with the "National Traffic and Motor Vehicle Safety Act of 1966".

► **Step 1:** Locate the statement "The combined weight of occupants and cargo

should never exceed XXX kg or XXX lbs." on your vehicle's Tire and Loading Information placard.

- **Step 2:** Determine the combined weight of the driver and passengers that will be traveling in your vehicle.
- **Step 3:** Subtract the combined weight of the driver and passengers from XXX kilograms or XXX lbs.
- **Step 4:** The resulting figure equals the available amount of cargo and luggage load capacity. For example, if the "XXX" amount equals 1400 lbs and there will be five 150 pound passengers in your vehicle, the amount of available cargo and luggage load capacity is 650 lbs (1400 - 750 (5 x 150) = 650 lbs).
- **Step 5:** Determine the combined weight of luggage and cargo being loaded on the vehicle. For reasons of safety, that weight must not exceed the available cargo and luggage cargo capacity calculated in step 4.
- **Step 6 (if applicable):** If you intend to tow a trailer behind your vehicle, the load on the trailer is transferred to your vehicle. Please consult the Tire and Loading Information placard, to determine how this reduces the available cargo and luggage load capacity of your vehicle.

Example: Steps 1 to 3

The following table shows examples of how to calculate total load and cargo capacities with varying seating configurations and number and size of occupants. The following examples use a maximum load of 1500 lbs (680 kg). **This is for illustration purposes only.** Make sure you are using the actual load limit for your vehicle stated on your vehicle's Tire and Loading Information placard .

		Example 1	Example 2	Example 3
Step 1	Combined maximum weight of occupants and cargo (data from the Tire and Loading Information placard)	1500 lbs (680 kg)	1500 lbs (680 kg)	1500 lbs (680 kg)

		Example 1	Example 2	Example 3
Step 2	Number of people in the vehicle (driver and occupants)	5	3	1
	Distribution of the occupants	Front: 2 Rear: 3	Front: 1 Rear: 2	Front: 1
	Weight of the occupants	Occupant 1: 150 lbs (68 kg) Occupant 2: 180 lbs (82 kg) Occupant 3: 160 lbs (73 kg) Occupant 4: 140 lbs (63 kg) Occupant 5: 120 lbs (54 kg)	Occupant 1: 200 lbs (91 kg) Occupant 2: 190 lbs (86 kg) Occupant 3: 150 lbs (68 kg)	Occupant 1: 150 lbs (68 kg)
	Gross weight of all occupants	750 lbs (340 kg)	540 lbs (245 kg)	150 lbs (68 kg)

		Example 1	Example 2	Example 3
Step 3	Permissible cargo and trailer load/noseweight (maximum gross vehicle weight rating from the Tire and Loading Information placard minus the gross weight of all occupants)	1500 lbs (680 kg) -750 lbs (340 kg) = 750 lbs (340 kg)	1500 lbs (680 kg) -540 lbs (245 kg) = 960 lbs (435 kg)	1500 lbs (680 kg) -150 lbs (68 kg) = 1350 lbs (612 kg)

The greater the combined weight of the occupants, the lower the maximum luggage load. Further information can be found under "Towing a trailer" (▷ page 178).

Vehicle identification plate

Even if you have calculated the total cargo carefully, you should still make sure that the gross vehicle weight rating and the gross axle weight rating are not exceeded. Details about this can be found on the vehicle identification plate on the driver seat frame of your vehicle (▷ page 319).

Gross vehicle weight: the gross weight of the vehicle, all passengers, cargo and trailer load/noseweight (if applicable) must not exceed the permissible gross vehicle weight.

Gross axle weight rating: the maximum permissible load that can be carried by one axle (front or rear axle).

To ensure that your vehicle does not exceed the maximum permissible values (gross vehicle weight and maximum gross axle weight rating), have your loaded vehicle (including driver, occupants, cargo, and full trailer load if applicable) weighed on a suitable vehicle weighbridge.

Trailer load/noseweight

The trailer load/noseweight affects the gross weight of the vehicle. If a trailer is attached, the trailer load/noseweight is included in the load along with occupants and luggage. The

trailer load/noseweight is usually approximately 10% of the gross weight of the trailer and its load.

What you should know about wheels and tires

Tire labeling

Overview

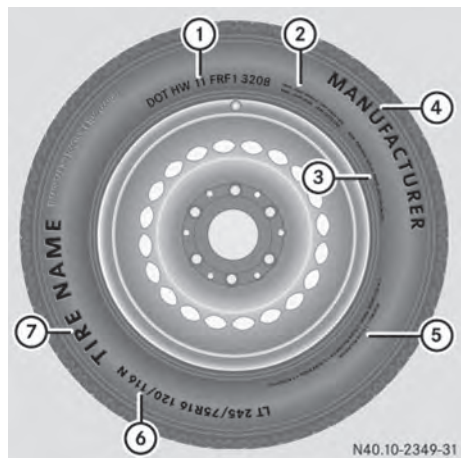

- ① DOT, Tire Identification Number (▷ page 304)
- ② Maximum tire load (▷ page 303)

- ③ Maximum tire pressure (▷ page 292)
- ④ Manufacturer
- ⑤ Tire material (▷ page 304)
- ⑥ Tire size designation, load-bearing capacity and speed index (▷ page 302)
- ⑦ Tire name

The markings described above are on the tire in addition to the tire name (sales designation) and the manufacturer's name.

- ⓘ Tire data is vehicle-specific and may deviate from the data in the example.

Tire size designation, load bearing index and speed index

WARNING

Exceeding the stated tire load-bearing capacity and the approved maximum speed could lead to tire damage or the tire bursting. There is a risk of accident.

Therefore, only use tire types and sizes approved for your vehicle model. Observe the tire load rating and speed rating required for your vehicle.



- ① Design standard
- ② Tire width
- ③ Nominal aspect ratio in %
- ④ Tire code
- ⑤ Rim diameter
- ⑥ Load bearing index
- ⑦ Speed index

General: depending on the manufacturer's standards, the size imprinted in the tire wall may not contain any letters or may contain one letter ① that precedes the size description

If "LT" precedes the size description (as shown above): these are light truck tires according to U.S. manufacturing standards.

If "C" precedes the size description: these are commercial motor vehicle tires according to European manufacturing standards.

Tire width: tire width ② shows the nominal tire width in millimeters.

Aspect ratio: aspect ratio ③ is the size ratio between the tire height and tire width and is shown in percent. The aspect ratio is calculated by dividing the tire width by the tire height.

Tire code: tire code ④ specifies the tire type. "R" represents radial tires. "D" represents diagonal tires, "B" represents diagonal radial tires.

Rim diameter: rim diameter ⑤ is the diameter of the bead seat, not the diameter of the rim flange. The rim diameter is specified in inches (in).

Load-bearing index: load-bearing index ⑥ is a numerical code that specifies the maximum load-bearing capacity of a tire.

Do not overload the tires by exceeding the specified load limit. The maximum permissible load can be found on the vehicle's Tire and Loading Information placard on the B-pillar on the driver's side (▷ page 298).

Example:

The load-bearing index 120 indicates a maximum load of 3,042 lb (1,380 kg) for the tire. If two load-bearing capacity indices are specified (as shown above), the first number states the load-bearing capacity for single tires, the second number the load-bearing capacity for twin tires. For further information on the maximum tire load in kilograms and pounds, see (▷ page 303).

For further information on the load-bearing index, see "Load index" (▷ page 303).

Speed rating: speed rating  specifies the approved maximum speed of the tire.

Regardless of the speed index always observe the speed limits. Drive carefully and adapt your driving style to the traffic conditions.

i Tire data is vehicle-specific and may deviate from the data in the example.

Index	Speed rating
F	up to 50 mph (80 km/h)
G	up to 56 mph (90 km/h)
J	up to 62 mph (100 km/h)
K	up to 68 mph (110 km/h)
L	up to 74 mph (120 km/h)
M	up to 80 mph (130 km/h)
N	up to 87 mph (140 km/h)
P	up to 93 mph (150 km/h)
Q	up to 100 mph (160 km/h)
R	over 106 mph (170 km/h)

i Not all tires that have the M+S identification offer the driving characteristics of winter tires. In addition to the M+S marking, winter tires also have the  snowflake symbol on the tire wall. Tires with this marking fulfill the requirements of the Rubber Manufacturers Association (RMA) and the Rubber Association of Canada (RAC) regarding the tire traction on snow. They have been especially developed for driving on snow.

Further information on the reading of tire information can be obtained at any qualified specialist workshop.

Load index



In addition to the load-bearing index, load rating  may be imprinted after the letters that identify speed rating on the sidewall of the tire (▷ page 302).

- If no specification is given: no text (as in the example above), represents a standard load (SL) tire
- XL or Extra Load: represents a reinforced tire
- Light Load: represents a light load tire
- C, D, E: represents a load range that depends on the maximum load that the tire can carry at a certain pressure

i Tire data is vehicle-specific and may deviate from the data in the example.

Maximum tire load



Maximum tire load  is the maximum permissible weight for which the tire is approved. Do not overload the tires by exceeding the specified load limit. The maximum permissible load can be found on the vehicle's Tire and

Loading Information placard on the B-pillar on the driver's side (▷ page 298).

- i** The actual values for tires are specific to each vehicle and may deviate from the values in the illustration.

DOT, Tire Identification Number (TIN)

U.S. tire regulations stipulate that every tire manufacturer or retreader must imprint a TIN in or on the sidewall of each tire produced.



The TIN is a unique identification number. The TIN enables the tire manufacturers or retreaders to inform purchasers of recalls and other safety-relevant matters. It makes it possible for the purchaser to easily identify the affected tires.

The TIN is made up of manufacturer identification code (2), tire size (3), tire type code (4) and manufacturing date (5).

DOT (Department of Transportation): tire symbol (1) indicates that the tire complies with the requirements of the U.S. Department of Transportation.

Manufacturer identification code: manufacturer identification code (2) provides details on the tire manufacturer. New tires have a code with two symbols. Retreaded tires have a code with four symbols.

Further information about retreaded tires (▷ page 286).

Tire size: identifier (3) describes the tire size.

Tire type code: tire type code (4) can be used by the manufacturer as a code to describe specific characteristics of the tire.

Date of manufacture: date of manufacture (5) provides information about the age of a tire. The first and second positions represent the week of manufacture, starting with "01" for the first calendar week. Positions three and four represent the year of manufacture. For example, a tire that is marked with "3208", was manufactured in week 32 in 2008.

- i** Tire data is vehicle-specific and may deviate from the data in the example.

Tire characteristics



This information describes the type of tire cord and the number of layers in sidewall (1) and under tire tread (2).

- i** Tire data is vehicle-specific and may deviate from the data in the example.

Definitions for tires and loading

Tire structure and characteristics

Describes the number of layers or the number of rubber-coated belts in the tire tread and the tire wall. These consist of steel, nylon, polyester, and other materials.

Bar

Metric unit for tire pressure.

14.5038 pounds per square inch (psi) and 100 kilopascals (kPa) are the equivalent of 1 bar.

DOT (Department of Transportation)

DOT marked tires fulfill the requirements of the United States Department of Transportation.

Average weight of vehicle occupants

The number of occupants for which the vehicle is designed multiplied by 68 kilograms (150 lbs).

Uniform Tire Quality Grading Standards

A uniform standard to grade the quality of tires with regard to tread quality, traction and temperature characteristics. The quality grading assessment is made by the manufacturer following specifications from the U.S government. The quality grade of a tire is imprinted on the sidewall of the tire.

Recommended tire pressure

The recommended tire pressure are the pressures specified for the tires mounted on the vehicle at the factory.

The Tire and Loading Information placard⁷ contains the recommended tire pressure for cold tires, the maximum permissible load and the maximum permissible vehicle speed.

The tire pressure table contains the recommended tire pressure for cold tires under various operating conditions, i.e. loading and/or speed of the vehicle.

Increased vehicle weight due to optional equipment

The combined weight of all standard and optional equipment available for the vehicle, regardless of whether it is actually installed on the vehicle or not.

Wheel rim

The part of the wheel on which the tire is mounted.

GAWR (Gross Axle Weight Rating)

GAWR is the maximum gross axle weight rating. The actual load on an axle must never exceed the gross axle weight rating. The

Gross Axle Weight Rating can be found on the vehicle identification plate on the driver seat frame (▷ page 319).

Speed index

The speed index is part of the tire identification. It specifies the speed range for which the tire is approved.

GTW (Gross Trailer Weight)

GTW is the total of weight of a trailer and the weight of the load, accessories etc. on the trailer.

GVW (Gross Vehicle Weight)

The gross vehicle weight includes the weight of the vehicle including fuel, tools, spare wheel, accessories installed, occupants, luggage and the drawbar noseweight if applicable. The gross vehicle weight may never exceed the gross vehicle weight rating (GVWR) specified on the vehicle identification plate at the base of the driver's seat (▷ page 319).

GVWR (Gross Vehicle Weight Rating)

The GVWR is the maximum permitted gross weight of the fully laden vehicle (weight of the vehicle including all accessories, occupants, fuel, luggage and the drawbar noseweight if applicable). The Gross Vehicle Weight Rating is specified on the vehicle identification plate on the driver seat frame (▷ page 319).

Maximum weight of the laden vehicle

The maximum weight is the sum of:

- the curb weight of the vehicle
- the weight of the accessories
- the load limit
- the weight of the factory installed optional equipment

Kilopascal (kPa)

Metric unit for tire pressure. 6.9 kPa are the equivalent of 1 psi. Another tire pressure unit

⁷ Only for vehicles with a gross weight of less than 10,000 lbs (4,536 kg).

is bar. 100 kilopascals (kPa) are the equivalent of 1 bar.

Load index

In addition to the load bearing index, a load index can be stamped onto the sidewall of the tire. It specifies the load-bearing capacity of the tire more precisely.

Curb weight

The weight of a vehicle with standard equipment including the maximum filling capacity of fuel, oil, and coolant. It also includes the air-conditioning system and optional equipment if these are installed on the vehicle, but does not include passengers or luggage.

Maximum tire load

The maximum tire load in kilograms or pounds is the maximum weight for which a tire is approved.

Maximum permissible tire pressure

Maximum permissible tire pressure for one tire.

Maximum load on one tire

Maximum load on one tire. This is calculated by dividing the maximum axle load of one axle by two.

PSI (Pounds per square inch)

Standard unit of measurement for tire pressure.

Aspect ratio

Relationship between tire height and width in percent.

Tire pressure

Pressure inside the tire applying an outward force to every square inch of the tire's surface. Tire pressure is specified in pounds per square inch (psi), in kilopascal (kPa) or in bar. Tire pressure should only be corrected when the tires are cold.

Cold tire pressure

The tires are cold:

- if the vehicle has been parked for at least three hours without direct sunlight on the tires, and
- if the vehicle has not been driven further than 1 mile (1.6 km)

Tire tread

The part of the tire that comes into contact with the road.

Tire bead

The tire bead ensures that the tire sits securely on the wheel. There are several steel wires in the bead to prevent the tire from coming loose from the wheel rim.

Sidewall

The part of the tire between the tread and the tire bead.

Weight of optional extras

The combined weight of those optional extras that weigh more than the replaced standard parts and more than 2.3 kg (5 lbs). These optional extras, such as high-performance brakes, level control, a roof rack or a high-performance battery, are not included in the curb weight and the weight of the accessories.

TIN (Tire Identification Number)

A unique identification number which can be used by a tire manufacturer to identify tires, for example for a product recall, and thus identify the purchasers. The TIN is composed of the manufacturer identification code, tire size, tire model code and manufacturing date.

Load bearing index

The load bearing index (also load index) is a code that contains the maximum load bearing capacity of a tire.

Traction

Traction is the result of friction between the tires and the road surface.

TWR (permissible trailer drawbar load)

The TWR is the maximum permissible weight that may act on the ball coupling of the trailer tow hitch.

Wear indicator

Narrow bars (tread wear bars) that are distributed over the tire tread. If the tire tread is level with the bars, the wear limit of $\frac{1}{16}$ in (1.6 mm) has been reached.

Distribution of the vehicle occupants

The distribution of vehicle occupants over designated seat positions in a vehicle.

Maximum permissible payload weight

Nominal load and goods/luggage load plus 68 kg (150 lbs) multiplied by the number of seats in the vehicle.

Flat tire**General notes**

Your vehicle is equipped with a spare wheel. The spare wheel is under the vehicle at the rear (▷ page 313).

Information about fitting a wheel can be found in the "Wheel change" section (▷ page 308).

When you replace a tire, we recommend that you also replace the tire valve. Please observe the safety-relevant information on tire valve (▷ page 292).

Changing wheels**Rotating the wheels****⚠ WARNING**

Interchanging the front and rear wheels may severely impair the driving characteristics if the wheels or tires have different dimensions. The wheel brakes or suspension components

may also be damaged. There is a risk of accident.

Rotate front and rear wheels only if the wheels and tires are of the same dimensions.

- ❗ On vehicles equipped with a tire pressure monitor, electronic components are located in the wheel.

Tire-mounting tools should not be used near the valve. This could damage the electronic components.

Only have tires changed at a qualified specialist workshop.

Always observe the instructions and safety notes in the "Mounting a wheel" section (▷ page 308).

The wear patterns on the front and rear tires differ, depending on the operating conditions. Rotate the wheels before a clear wear pattern has formed on the tires. Front tires typically wear more on the shoulders and the rear tires in the center.

If your vehicle's tire configuration allows, you can rotate the wheels according to the intervals in the tire manufacturer's warranty book in your vehicle documents. If no warranty book is available, the tires should be rotated every 3,000 to 6,000 miles (5,000 to 10,000 km), or earlier if tire wear requires. Do not change the direction of rotation.

Clean the contact surfaces of the wheel and the brake disc thoroughly every time a wheel is rotated. Check the tire pressure and reactivate the tire pressure monitor if necessary.

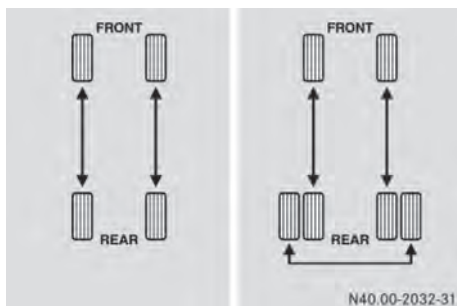

Diagram showing tire rotation for single and dual tires

Single tires: if the tires are of identical dimensions, you can rotate both wheels on both the front and rear axles so that the tires' original direction of rotation is maintained. On unidirectional tires, an arrow on the sidewall shows the prescribed direction of rotation of the tire.

Twin rear tires: if the tires are of identical dimensions, you can rotate the wheels on the front axle and the inner wheels on the rear axle in pairs such that the original direction of tire rotation is retained. With unidirectional tires, you may rotate the outside wheels at the rear axle from one side to the other.

Direction of rotation

Tires with a specified direction of rotation have additional benefits, e.g. if there is a risk of hydroplaning. You will only gain these benefits if the correct direction of rotation is observed.

An arrow on the sidewall of the tire indicates its correct direction of rotation.

You may mount a spare wheel against the direction of rotation. Observe the time restriction on use as well as the speed limitation specified on the spare wheel.

Storing wheels

Store wheels that are not being used in a cool, dry and preferably dark place. Protect the tires from contact with oil, grease and fuel.

Mounting a wheel

Vehicle preparation

- ▶ Stop the vehicle as far away as possible from traffic and on a level, firm and non-slip surface.
- ▶ If your vehicle poses a risk to approaching traffic, switch on the hazard warning lamps.
- ▶ Apply the parking brake.
- ▶ Turn the front wheels to the straight-ahead position.
- ▶ Move the selector lever of the automatic transmission to position **P**.
- ▶ Switch off the engine.
- ▶ Passengers should leave the vehicle. Make sure that the passengers are not endangered as they do so.
- ▶ Make sure that no one is near the danger area while the wheel is being changed. Anyone who is not directly assisting in the wheel change should, for example, stand behind the barrier.
- ▶ Place the warning triangle or warning lamp at a suitable distance.
Observe legal requirements.
- ▶ Secure the vehicle to prevent it from rolling away.
- ▶ **i** Observe the safety notes on parking in the section on "Driving and parking" (▷ page 151).
- ▶ **On level terrain:** place chocks or other suitable objects under the front and rear of the wheel that is diagonally opposite the wheel to be changed.
- ▶ **On slight inclines:** place chocks or other suitable objects under the wheels on the front and rear axles opposite the wheel to be changed.

- ▶ Take the vehicle tool kit and the jack from the footwell on the co-driver's side (▷ page 276).
- ▶ Remove the spare wheel from the spare wheel bracket (▷ page 314). Observe the safety notes in the "Spare wheel" section (▷ page 313).
- ▶ On wheels with wheel bolts, remove the hub caps.

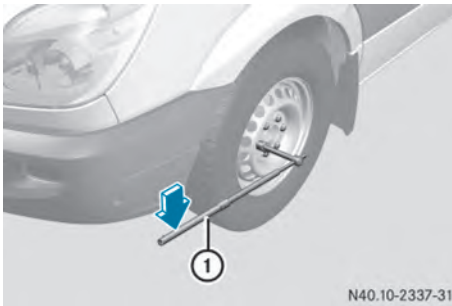

- ▶ Assemble the lug wrench extension using the middle rod and the rod with the largest diameter from the three-piece jack pump lever.
- ▶ Starting with the middle rod, slide the lug wrench extension as far as it will go onto the lug wrench.
- ▶ Using lug wrench ①, loosen the wheel bolts/wheel nuts on the wheel to be changed by about one full turn. Do not unscrew the wheel bolts/nuts completely.

Raising the vehicle

WARNING

If you do not position the jack correctly at the appropriate jacking point of the vehicle, the jack could tip over with the vehicle raised. There is a risk of injury.

Only position the jack at the appropriate jacking point of the vehicle. The base of the jack must be positioned vertically, directly under the jacking point of the vehicle.

WARNING

On uphill and downhill slopes, the jack could tip over with the vehicle raised. There is a risk of injury.

Do not change wheels on uphill or downhill gradients. Notify a qualified specialist workshop.

- ❗ Only position the jack on the jacking points intended for this purpose. You could otherwise damage the vehicle.

Observe the following when raising the vehicle:

- When raising the vehicle, only use the jack which Mercedes-Benz has specifically approved for your vehicle.
- The vehicle's jack is intended only to raise the vehicle for a short time when changing a wheel. It is not suited for performing maintenance work under the vehicle.
- Avoid changing the wheel on uphill and downhill slopes.
- Before raising the vehicle, secure it from rolling away by applying the parking brake and inserting wheel chocks. Never disengage the parking brake while the vehicle is raised.
- The jack must be placed on a firm, flat and non-slip surface. On a loose surface, a large, load-bearing underlay must be used. On a slippery surface, a non-slip underlay must be used, e.g. rubber mats.
- Make sure that the distance between the underside of the tires and the ground does not exceed 1,2 in(3 cm).
- Never place your hands or feet under the raised vehicle.
- Never lie under the raised vehicle.
- Never start the engine when the vehicle is raised.
- Never open or close a door when the vehicle is raised.
- Make sure that no persons are present in the vehicle when the vehicle is raised.

❗ Only use the jack pump lever middle rod and the rod with the largest diameter as a lug wrench extension. Only slide the middle rod as far as it will go onto the lug wrench. The rods may otherwise bend and be distorted to such an extent that they can no longer be used as a pump lever for the jack.

❗ Do not place the jack on the leaf spring or the differential case.

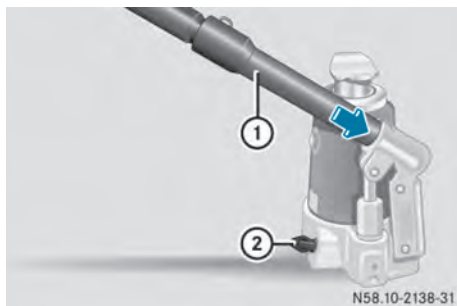

Hydraulic jack

Preparing the hydraulic jack

- ▶ Insert the third rod of jack pump lever ① into the lug wrench extension. Jack pump lever ① is assembled.
- ▶ Close pressure release screw ②.
- ▶ To do this, use the flattened section on pump lever ① to turn pressure release screw ② clockwise to the stop.
- ❗ Do not turn pressure release screw ② more than 1 or 2 full turns. Hydraulic fluid could otherwise escape.
- ▶ Insert pump lever ① into the recess on the jack and secure by turning it clockwise.
- ▶ Place the jack vertically beneath the jacking points described below.



Jacking point, front axle

Jacking point at the front axle

- ▶ Place the jack under the longitudinal member in front of the front axle.

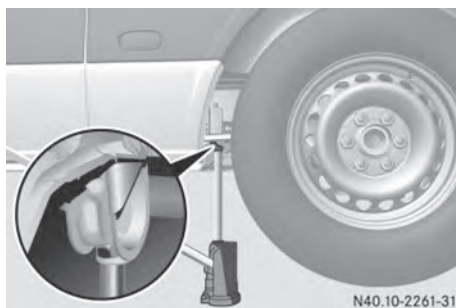

Jacking point, rear axle (example: vehicle type 2500)

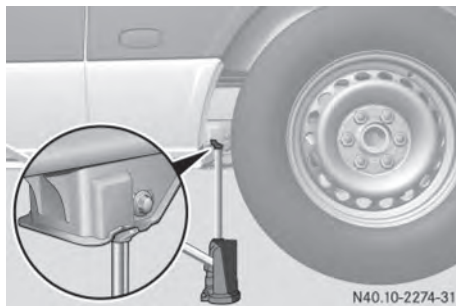

Jacking point, rear axle (example: vehicle type 3500)

Jacking point at the rear axle on vehicle types 2500 and 3500

- ▶ Place the jack under the longitudinal member in front of the rear axle.

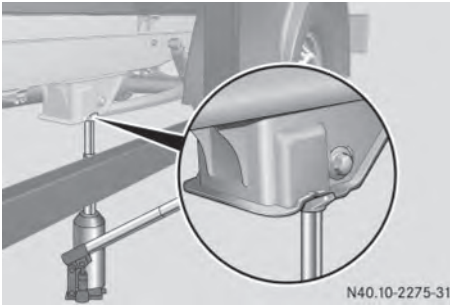

Jacking point, rear axle (example: Cab Chassis) Jacking point at the rear axle on chassis versions

- ▶ Place the jack next to the front leaf spring support beneath the jacking point.

Raising the vehicle

- ▶ Move pump lever ① up and down until the tire is a maximum of 1.2 in (3 cm) off the ground.

Removing a wheel

- ❗ Do not place the wheel bolts or the wheel nuts in sand or dirt. The threads of the wheel bolts and wheel nuts could otherwise be damaged when being tightened.
- ▶ Unscrew the wheel bolts or nuts.
- ▶ On front wheels with wheel nuts, remove the wheel nut cover.
- ▶ Remove the wheel.

Mounting a new wheel

⚠ WARNING

Oiled or greased wheel bolts or damaged wheel bolts/hub threads can cause the wheel bolts to come loose. As a result, you could lose a wheel while driving. There is a risk of accident.

Never oil or grease wheel bolts. In the event of damage to the threads, contact a qualified specialist workshop immediately. Have the damaged wheel bolts or hub threads replaced/renewed. Do not continue driving.

⚠ WARNING

If you tighten the wheel bolts or wheel nuts when the vehicle is raised, the jack could tip over. There is a risk of injury.

Only tighten the wheel bolts or wheel nuts when the vehicle is on the ground.

Always observe the instructions and safety notes on "Changing a wheel" (▷ page 307).

Only use wheel bolts or wheel nuts that have been designed for the wheel and the vehicle. For safety reasons, we recommend that you only use wheel bolts or wheel nuts which have been approved for Sprinter vehicles and the respective wheel.

- ❗ For a steel wheel, only use the short wheel bolts to mount the steel spare wheel. Using other wheel bolts to mount the steel spare wheel could damage the brake system.

- ❗ On vehicles equipped with a tire pressure monitor, electronic components are located in the wheel.

Tire-mounting tools should not be used near the valve. This could damage the electronic components.

Only have tires changed at a qualified specialist workshop.

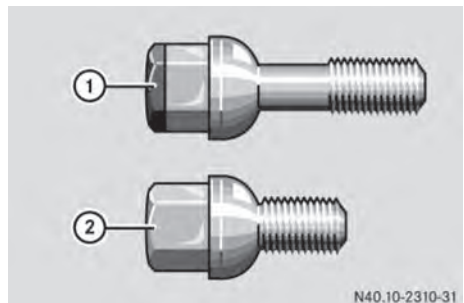

① Wheel bolt for alloy wheel

② Wheel bolt for steel wheel

- ▶ Clean the wheel and wheel hub contact surfaces.
- ▶ Slide the new wheel onto the wheel hub and push it on.

Wheels with centering by wheel bolts:

- ▶ Vehicles with alloy wheels: take the short wheel bolts that fit the steel spare wheel out of the vehicle tool kit.
- ▶ Screw in the wheel bolts and tighten them lightly.

For wheels with wheel nuts:

- ▶ Front wheels with wheel nut covers: press the wheel nut covers onto the wheel nuts.
- ▶ Screw in the three wheel nuts over the fixing discs of the wheel nut cover.
- ▶ Turn the wheel so that the wheel bolts are in the middle of the holes.
- ▶ Screw on the rest of the wheel nuts.
- ▶ Slightly tighten all the wheel nuts.

Lowering the vehicle

WARNING

The wheels could work loose if the wheel nuts and bolts are not tightened to the specified tightening torque. There is a risk of accident. Have the tightening torque immediately checked at a qualified specialist workshop after a wheel is changed.

- ❗ Only use the jack pump lever middle rod and the rod with the largest diameter as a lug wrench extension. Only slide the middle rod as far as it will go onto the lug wrench. The rods may otherwise bend and be distorted to such an extent that they can no longer be used as a pump lever for the jack.

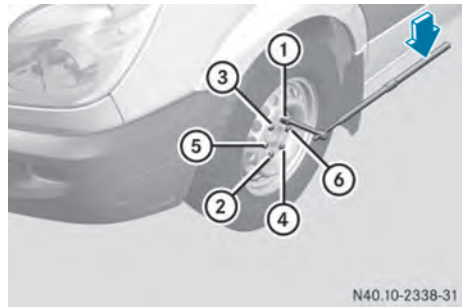

Tightening torque pattern

①—⑥ Wheel bolts or wheel nuts

- ▶ Using the pump lever, slowly turn the lowering screw on the jack through approximately one revolution and carefully lower the vehicle (▷ page 309).
- ▶ Put the jack aside.
- ▶ Pull the rod with the smallest diameter off the pump lever. The shortened pump lever serves as a lug wrench extension.
- ▶ Starting with the middle rod, slide the lug wrench extension as far as it will go onto the lug wrench.
- ▶ Using the extended lug wrench, tighten the wheel bolts evenly in a crosswise pattern in the sequence indicated (① to ⑥).

Tighten the wheel bolts to the following tightening torques:

- Steel wheel **177 lb-ft (240 Nm)**
- Light-alloy wheel **133 lb-ft (180 Nm)**

Tighten the wheel nuts to a tightening torque of **133 lb-ft (180 Nm)**.

- ▶ Push the piston on the hydraulic jack in again and close the pressure release screw.
- ▶ Stow the jack and the rest of the vehicle tools in the vehicle again.
- i** You can now install the hub caps on steel wheels with wheel bolts. The installing procedure depends on whether the hub cap acts as a trim that covers the whole wheel, or just covers the center.

- ▶ Wheel with hub cap: position the opening for the tire valve in the hub cap over the tire valve.
- ▶ Push the edge of the hub cap with both hands against the wheel until it clicks into place. Make sure the hub cap retaining catches engage on the steel wheel.
- ▶ Wheel with central hub cap: position the retaining lugs of the central hub cap over the wheel bolts.
- ▶ Hit the middle of the hub cap to engage it on the wheel.
- ▶ Secure the faulty wheel in the spare wheel bracket (▷ page 314).
- ▶ Check the tire pressure of the newly mounted wheel and adjust it if necessary. Observe the recommended tire pressure (▷ page 290).
- ▶ Retighten the wheel bolts or wheel nuts to the specified tightening torque after the vehicle has been driven for 30 miles (50 km).

When using a wheel/spare wheel with a new or newly painted wheel rim, have the wheel bolts/nuts retightened again after approximately 600 to 3,000 miles (1,000 to 5,000 km). Observe the specified tightening torque.

- i** Vehicles with the tire pressure monitor system: all mounted wheels must be equipped with functioning sensors.

Wheel and tire combination

General notes

- !** Retreaded tires are neither tested nor recommended for Sprinter vehicles, since previous damage cannot always be detected on retreaded tires. We can therefore not guarantee driving safety. Do not mount used tires if you have no information about their previous usage.

The recommended tire pressures can be found:

- on the Tire and Loading Information placard⁸ on the B-pillar on the driver's side
- on the tire pressure table on the B-pillar on the driver's side

The recommended tire pressure can also be found in the "Tire pressure table" section in these Operating Instructions (▷ page 297). The wheel/tire combination for your vehicle can be found on the tire pressure table. Further information on wheel/tire combination can be obtained at any qualified specialist workshop.

Check tire pressures regularly and only when the tires are cold. Observe the notes on the recommended tire pressures (▷ page 290).

Follow the maintenance recommendations in the tire manufacturer's warranty book in your vehicle documents.

Notes on the vehicle equipment – always install the vehicle:

- with tires of the same size across an axle (left/right)
- with the same type of tires on all wheels at a given time (summer tires, winter tires)

Spare wheel

Important safety notes

WARNING

Wheel and tire dimensions as well as the type of tire can vary between the spare wheel and the wheel to be replaced. When the spare wheel is mounted, driving characteristics may be severely affected. There is a risk of an accident.

In order to reduce risks:

- you should therefore adapt your driving style and drive carefully.
- never mount more than one spare wheel that differs from the wheel to be replaced.

⁸ Only for vehicles with a gross weight of less than 10,000 lbs(4,536 kg).

- only use a spare wheel that differs from the wheel to be replaced for a short time.
- do not deactivate ESP®.
- have a spare wheel that differs from the wheel that has been changed replaced at the nearest qualified specialist workshop. You must observe the correct wheel and tire dimensions as well as the wheel type.

When using a spare wheel of a different size, do not exceed the maximum speed of 80 km/h.

General notes

- !** Check the spare wheel regularly to see that it is secure and has the prescribed tire pressure.

The procedure for mounting the spare wheel is described in "Mounting a wheel" (> page 308).

The following should be checked regularly, particularly prior to long journeys:

- the tire pressure of the spare wheel, which should then be corrected if necessary (> page 290).
- the fastenings of the spare wheel bracket.

The spare wheel is located in a spare wheel bracket under the rear of the vehicle.

Replace the tires after 6 years at the latest, regardless of wear. This also applies to the spare wheel.

- i** If you have mounted a spare wheel, the tire pressure monitor (> page 293) will not function for this wheel. The spare wheel is not equipped with a sensor for monitoring tire pressure.

Removing and installing the spare wheel

Cargo Van/Passenger Van

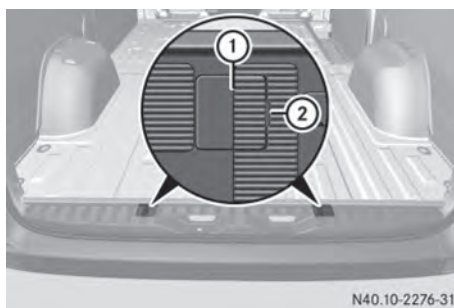

N40.10-2276-31

Bolt covers for the safety catches (example: Cargo Van)

Removing

- ▶ Open the rear doors.
- ▶ Place a screwdriver into recesses ② and then prise off covers ①.
- ▶ Using the lug wrench from the vehicle tool kit (> page 276), unscrew the now visible bolts counter-clockwise by approximately 20 turns.

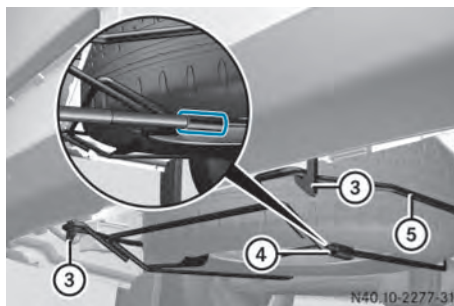

N40.10-2277-31

Spare wheel carrier under the vehicle

- ▶ Slightly raise spare wheel bracket ⑤ and unhook left-hand retaining hook ③.
- ▶ Assemble the pump lever for the jack and slide it into sleeve ④ on spare wheel bracket ⑤.
- ▶ Raise spare wheel bracket ⑤ with the pump lever and unhook right-hand retaining hook ③.

- ▶ Slowly lower spare wheel bracket ⑤ down to the ground.
- ▶ Lift spare wheel bracket ⑤ slightly and pull the pump lever out of sleeve ④.

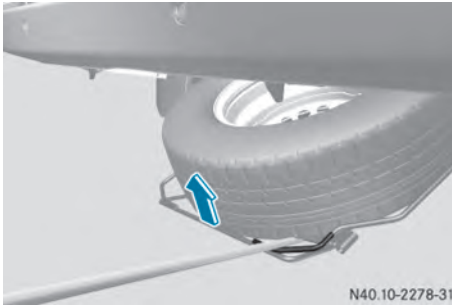

Spare wheel in the spare wheel carrier

- ▶ Use the pump lever to lift the spare wheel beyond the rear edge of the spare wheel carrier.
- ▶ Carefully remove the spare wheel from spare wheel bracket ⑤.
The spare wheel is heavy. When the spare wheel is removed, the center of gravity changes due to the heavy weight of the wheel. The spare wheel may slip down or tip over.

Installing

- ▶ Carefully place the spare wheel onto spare wheel bracket ⑤.
The spare wheel is heavy. When you place the spare wheel onto spare wheel bracket ⑤, the center of gravity changes due to the weight of the wheel. The spare wheel may slip down or tip over.
- ▶ Slide the pump lever for the jack into sleeve ④ on spare wheel bracket ⑤.
- ▶ Raise spare wheel bracket ⑤ with the pump lever and attach right-hand retaining hook ③.
- ▶ Slightly raise spare wheel bracket ⑤ and attach left-hand retaining hook ③.
- ▶ Pull the pump lever out of sleeve ④.
- ▶ Using the lug wrench, tighten the retaining hook bolts by turning them clockwise.

- ▶ Replace and engage covers ①.
- ▶ Close the rear doors.

Cab Chassis version

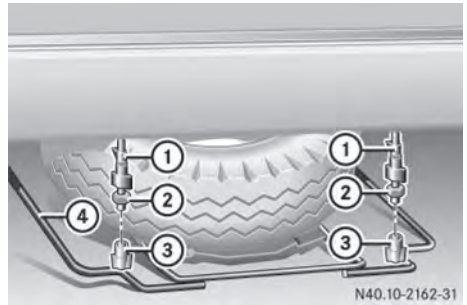

Removing

- ▶ Loosen fender nuts ③ manually and then remove them.
- ▶ Loosen nuts ② as far as the thread end.
- ▶ Slightly raise spare wheel bracket ④ and unhook left-hand retaining hook ①.
- ▶ Assemble the pump lever for the jack and slide it into the sleeve on the right-hand side of spare wheel bracket ④.
- ▶ Raise spare wheel bracket ④ with the pump lever and unhook right-hand retaining hook ①.
- ▶ Slowly lower spare wheel bracket ④ down to the ground.
- ▶ Lift spare wheel bracket ④ slightly and pull the pump lever out of the sleeve.

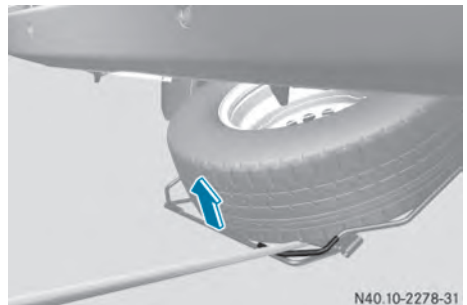

- ▶ Use the pump lever to lift the spare wheel beyond the rear edge of spare wheel bracket ④.
- ▶ Carefully remove the spare wheel from the bracket.
The spare wheel is heavy. When the spare wheel is removed, the center of gravity changes due to the heavy weight of the wheel. The spare wheel may slip down or tip over.

Installing

- ▶ Carefully place the spare wheel onto spare wheel bracket ④.
The spare wheel is heavy. When you place the spare wheel onto spare wheel bracket ④, the center of gravity changes due to the weight of the wheel. The spare wheel may slip down or tip over.
- ▶ Raise spare wheel bracket ④ with the pump lever and attach right-hand retaining hook ①.
- ▶ Slightly raise spare wheel bracket ④ and attach left-hand retaining hook ①.
- ▶ Pull the pump lever out.
- ▶ Tighten nuts ②.
- ▶ Put fender nuts ③ in place and tighten them.

Genuine Sprinter parts	318
Vehicle electronics	318
Identification plates	319
Service products and capacities	320
Vehicle data	331

Genuine Sprinter parts

! Air bags and Emergency Tensioning Devices, as well as control units and sensors for these restraint systems, may be installed in the following areas of your vehicle:

- doors
- door pillars
- door sills
- seats
- cockpit
- instrument cluster
- center console

Do not install accessories such as audio systems in these areas. Do not carry out repairs or welding. You could impair the operating efficiency of the restraint systems.

Have aftermarket accessories installed at a qualified specialist workshop.

Environmental note

We supply reconditioned assemblies and parts which are of the same quality as new parts. The same New Vehicle Limited Warranty applies as for new parts.

We test genuine Sprinter parts, as well as conversion parts and accessories that have been specifically approved for the type of vehicle, for:

- reliability
- safety
- suitability

Despite ongoing market research, we are unable to assess other parts. If individual or official approval is given, we assume no responsibility for use in Sprinter vehicles.

In some countries, certain parts are only officially approved for installation or modification if they comply with legal requirements. All genuine Sprinter parts satisfy these requirements. Make sure that all parts are suitable for your vehicle.

All authorized Sprinter Dealers maintain a supply of genuine Sprinter parts for required service and repair work. Also, the strategically distributed parts delivery centers provide quick and reliable parts service.

Always specify the vehicle identification number (VIN) and engine number when ordering genuine Sprinter parts (▷ page 319).

Vehicle electronics

Tampering with the engine electronics

WARNING

Always have work on the engine electronics and related components carried out at a qualified specialist workshop. Otherwise, the vehicle's operating safety could be affected.

! Only have engine electronics and the corresponding parts, such as control units, sensors or connector leads, serviced in a qualified specialist workshop. Otherwise, the vehicle parts may wear more quickly. This can lead to loss of the New Vehicle Limited Warranty.

Installing electrical or electronic equipment

WARNING

You and others may damage your health due to excessive electromagnetic radiation. By using an external antenna, the possible health risks of electromagnetic fields, which are under discussion among the scientific community, should be largely prevented.

Therefore, only have the exterior antenna installed at a qualified specialist workshop.

Electrical and electronic devices may have a detrimental effect on both the comfort and the operating safety of the vehicle. If equipment of this kind is retrofitted, its electro-

magnetic compatibility must be checked and verified.

If these devices are linked to functions associated with resistance to interference, they must have type approval. This applies to the device or its interfaces to the vehicle electronics, e.g. charging brackets.

A telephone or two-way radio to be installed in the vehicle must be approved. Further information can be obtained from any Sprinter Dealer.

For operation of mobile phones and two-way radios, we recommend connection to an approved exterior antenna. This is the only way to ensure optimum reception quality inside the vehicle and to minimize mutual interference between the vehicle electronics, mobile phones and two-way radios.

The transmission output of the mobile phone or two-way radio may not exceed the following maximum transmission output (PEAK):

Frequency range	Maximum transmission output (PEAK)
Short wave (f < 50 MHz)	100 W
4 m waveband	30 W
2 m waveband	50 W
Trunked radio/Tetra	35 W
70 cm waveband	35 W
GSM 900/AMPS	10 W
GSM 1800	10 W
UMTS	10 W

Identification plates

Vehicle identification plate with vehicle identification number (VIN)

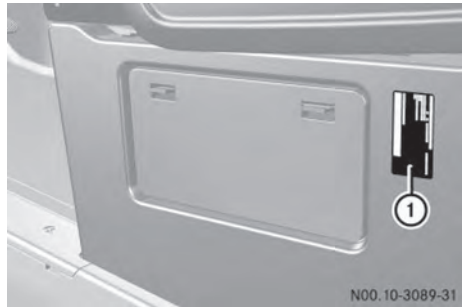

Vehicle identification plate for vehicles or chassis on the base of the driver's seat

- Open the driver's door. You will see vehicle identification plate ① with the vehicle identification number (VIN), the paint code and the permissible weight data.



Example: vehicle identification plate (US vehicles)

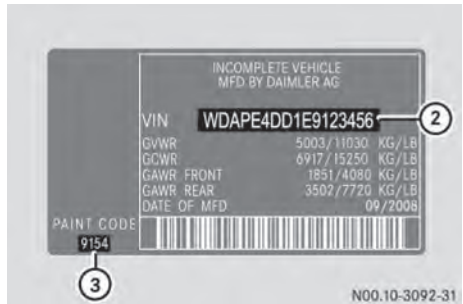

Example: chassis identification plate (US vehicles)



Example: chassis identification plate (vehicles for Canada)

- ② VIN
- ③ Paint code

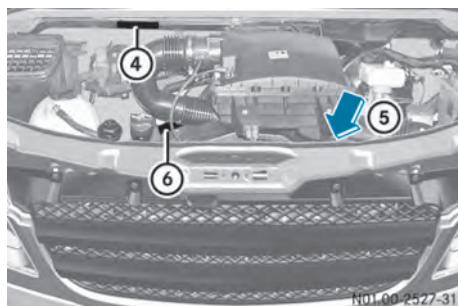

Engine compartment

- ④ VIN (stamped on the rear wall of the engine compartment)
- ⑤ Engine number (stamped on the crank-case)
- ⑥ Emission Control Information and engine oil⁹ instruction labels

► Open the hood (► page 250).

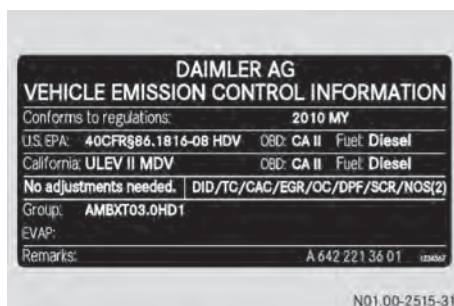

Example: Emission Control Information label

- ① Such data is vehicle-specific and may differ from that shown. Always observe the specifications on your vehicle's identification plate.

Engine number

The engine number is stamped on the crank-case. More information may be obtained at any qualified specialist workshop.

Service products and capacities

Important safety notes

⚠ WARNING

Service products may be poisonous and hazardous to health. There is a risk of injury.

Comply with instructions on the use, storage and disposal of service products on the labels of the respective original containers. Always store service products sealed in their original containers. Always keep service products out of the reach of children.

♻ Environmental note

Dispose of service products in an environmentally responsible manner.

⁹ Also observe the notes on engine oil for diesel engines in the "Technical data" section.

Service products include the following:

- Fuels, e.g. diesel
- Additives for the exhaust gas aftertreatment, e.g. Diesel Exhaust Fluid (DEF)
- Lubricants, e.g. engine oil, transmission oil
- Coolant
- Brake fluid
- Washer fluid
- Climate control system refrigerants

Approved service products comply with the highest quality standards and are listed in the MB Specifications for Service Products. Only use service products approved for the vehicle. This is an important condition for the warranty.

You will recognize the approved service products by the inscription on the container: MB Approval (e.g. MB Approval 228.5)

Other identifications and recommendations refer to quality level or a specification according to an MB Sheet Number (e.g. MB 228.5). They are therefore not necessarily approved.

Further information can be obtained at any qualified specialist workshop.

Additives for approved service products are neither required nor permitted. Approved fuel additives are the exception. Additives can cause engine damage and must therefore not be added to the service products.

The use of additives is always the responsibility of the vehicle operator. The use of additives may result in the restriction or loss of your Limited Warranty entitlements.

Fuel

Important safety notes

WARNING

Fuel is highly flammable. Improper handling of fuel creates a risk of fire and explosion.

Avoid fire, open flames, smoking and creating sparks under all circumstances. Switch off the engine and, if applicable, the auxiliary heating before refueling.

WARNING

Fuel is poisonous and hazardous to health. There is a risk of injury.

You must make sure that fuel does not come into contact with your skin, eyes or clothing and that it is not swallowed. Do not inhale fuel vapors. Keep fuel away from children.

If you or others come into contact with fuel, observe the following:

- Wash away fuel from skin immediately using soap and water.
- If fuel comes into contact with your eyes, immediately rinse them thoroughly with clean water. Seek medical assistance without delay.
- If fuel is swallowed, seek medical assistance without delay. Do not induce vomiting.
- Immediately change out of clothing which has come into contact with fuel.

When handling, storing and disposing of fuels, please observe the relevant regulations.

Tank contents

Depending on equipment, the total capacity of the fuel tank may vary.

Total capacity	
210 CDI, 213 CDI, 216 CDI, 219 CDI, 310 CDI, 313 CDI, 316 CDI, 319 CDI, 510 CDI, 513 CDI, 516 CDI, 519 CDI 216, 316, 516	Approximately 75 l Or Approximately 100 l ¹⁰ Or Approximately 72 l ¹¹

of which reserve fuel	
Models with approximately 72 l total capacity	Approximately 12 l
Models with approximately 75 l total capacity	Approximately 13 l
Models with approximately 100 l total capacity	Approximately 20 l

Diesel

Fuel grade

WARNING

If you mix diesel fuel with gasoline, the flash point is lower than that of pure diesel fuel. When the engine is running, exhaust system components could overheat without being noticed. There is a risk of fire.

Never refuel with gasoline. Never mix gasoline with diesel fuel.

-  Filter the fuel before transferring it to the vehicle if you are refueling the vehicle from barrels or containers.

This will prevent malfunctions in the fuel system due to contaminated fuel.

-  **Vehicles without a diesel particle filter:** in countries where only diesel fuel with a high sulfur content is available, you will need to carry out your vehicle's oil change at shorter intervals. Further information on oil change intervals can be obtained at a qualified specialist workshop.

Sprinter with Euro 3 diesel engine

You will damage the diesel engine and the diesel particle filter (DPF) if you refuel with the following diesel fuels:

- diesel fuel with a sulfur content of more than 2,500 ppm
- diesel fuel with a bio-diesel content of more than 10%
- diesel fuel with a bio-diesel content of up to 10%, which does not fulfill the requirements stated under "Fuel grade"

Sprinter with Euro 4 diesel engine

You will damage the diesel engine and the diesel particle filter (DPF) if you refuel with the following diesel fuels:

- diesel fuel with a sulfur content of more than 500 ppm
- diesel fuel with a bio-diesel content of more than 7%
- diesel fuel with a bio-diesel content of up to 7%, which does not fulfill the requirements stated under "Fuel grade"

Sprinter with Euro 5 diesel engine

You will damage the diesel engine and the diesel particle filter (DPF) if you refuel with the following diesel fuels:

- low-sulfur diesel fuel with a maximum sulfur content of 500 ppm
- diesel fuel with a sulfur content of more than 50 ppm

¹⁰ Optional equipment.

¹¹ Only valid for low chassis vehicles.

- diesel fuel with a bio-diesel content of more than 7%
- diesel fuel with a bio-diesel content of up to 7%, which does not fulfill the requirements stated under "Fuel grade"

The sulfur content of the diesel fuel may not exceed the following values:

Euro 6 diesel engine	50 ppm
Euro 5 diesel engine	≥ 50 ppm
Euro 4 diesel engine	≥ 500 ppm
Euro 3 diesel engine	≥ 2500 ppm

You will generally find information about the fuel grade on the filling pump. If there is no identification on the filling pump, consult a gas station attendant.

For more information about refueling (▷ page 148).

- You can obtain information about modification options for operation with alternative fuels (bio-diesel fuels) from any authorized Mercedes-Benz Center.

Diesel at very low outside temperatures

WARNING

If you heat fuel system components, e.g. with a hot-air gun or open flame, these components could be damaged. This can cause fuel to escape and ignite. Depending on the type of damage, fuel may also not escape until the engine is running. There is a risk of fire and explosion.

Never heat fuel system components. Contact a qualified specialist workshop to rectify the malfunction.

Refill only with commercially available ULTRA-LOW SULFUR DIESEL (ULSD, maximum sulfur content 15 ppm), which fulfills the ASTM D975 standard.

The flow properties of diesel may be inadequate at low outside temperatures due to paraffin separation.

- Malfunctions resulting from paraffin separation can only be rectified by heating the entire fuel system. Park the vehicle in a heated garage, for example.

To prevent operating problems, diesel with better flow qualities is available during the winter months. You can obtain information at the gas station or from your fuel supplier.

Your vehicle is equipped with a fuel preheating system. This improves the flow properties of the diesel by approximately 46 °F (8 °C). ULTRA-LOW SULFUR DIESEL can be used without risk of malfunction down to an outside temperature of approximately 14 °F (-10 °C).

Fuel additives

- Do not add gasoline or kerosene to diesel fuel to improve its flow characteristics. Gasoline or kerosene impairs the lubricating properties of the diesel fuel. This can result in damage to the fuel injection system, for example.

Information on fuel consumption

Environmental note

CO₂ (carbon dioxide) is the gas which scientists believe to be principally responsible for global warming (the greenhouse effect). Your vehicle's CO₂ emissions are directly related to fuel consumption and therefore depend on:

- efficient use of the fuel by the engine
- driving style
- other non-technical factors, such as environmental influences, road conditions or traffic flow

You can minimize your vehicle's CO₂ emissions by driving carefully and having it serviced regularly.

- Only for certain countries: the respective current consumption and emission values of your vehicle can be found in the COC papers (EC CERTIFICATE OF CONFORM-

ITY). These documents are supplied when the vehicle is delivered.

Consumption figures were found in the currently valid respective version:

- for vehicles from the Euro 5 standard according to regulation (EC) no. 715/2007
- for vehicles from the Euro 6 standard according to regulation (EC) no. 595/2009

Fuel consumption depends on:

- the vehicle version
- the style of driving
- the operating conditions
- the type or quality of the fuel used

The vehicle will use more fuel than usual in the following situations:

- at very low outside temperatures
- in city traffic
- during short journeys
- on mountainous terrain
- when towing a trailer

To keep fuel consumption low, observe the advice in the "Protection of the environment" section (▷ page 22).

The following components of the different vehicle versions influence fuel consumption:

- tire sizes, tire tread, tire pressure, tire condition
- body
- transmission ratios for the drive assemblies
- additional equipment (e.g. air-conditioning system, auxiliary heating system).

For these reasons, the actual consumption figures for your vehicle may deviate from the consumption figures determined according to EU Directive 80/1268/EEC.

Data concerning fuel consumption are recorded in the on-board computer; use the steering wheel buttons to call up the **Trip computer** menu (▷ page 197).

Diesel Exhaust Fluid (DEF)

General notes

❗ Only use DEF in accordance with ISO 22241. The exhaust gas aftertreatment system may otherwise be damaged.

Observe the MB Specifications for Service Products, Sheet No. 352.0.

Damage caused by the use of other reducing agents will invalidate the New Vehicle Limited Warranty.

❗ If DEF comes into contact with a painted or aluminum surface, wash the surface off immediately with plenty of water.

High ambient temperatures

When opening the DEF tank filler cap at high outside temperatures, ammonia vapors may escape. Ammonia vapors have a pungent odor and are particularly irritating for your skin, respiratory organs and eyes. This may result in burning eyes, nose and throat, as well as coughing and watering eyes. Do not inhale ammonia vapors.

If DEF heats up, e.g. in direct sunlight, in the DEF supply reservoir for some time to over 122 °F (50 °C), ammonia vapor will develop.

Low ambient temperatures

DEF freezes at a temperature of approximately 12 °F (-11 °C). The vehicle is equipped with a DEF preheating system at the factory. Winter operation is therefore also guaranteed at temperatures under 12 °F (-11 °C).

Additives and tap water

❗ Do not mix DEF with any additives and do not dilute DEF with tap water. Otherwise, the exhaust gas aftertreatment may be damaged.

Observe the MB Specifications for Service Products, Sheet No. 352.0.

Damage that arises through the use of additives or tap water will invalidate the New Vehicle Limited Warranty.

Storage

I Containers made of aluminum, copper, copper alloys as well as unalloyed or galvanized steel are not suitable for storing DEF. If stored in these types of containers, DEF could cause constituents of these metals to dissolve and cause irreparable damage to the exhaust gas aftertreatment.

Damage caused by such impurities in the DEF will invalidate the New Vehicle Limited Warranty.

Only store DEF in containers made of high-alloy Cr-Ni steel or Mo-Cr-Ni steel in accordance with DIN EN 10 088-1/2/3 or plastic containers made of polypropylene or polyethylene.

Purity

I Impurities in DEF (e.g. caused by other service products, cleaning agents, dust, etc.) result in increased emissions, malfunctions, catalytic converter damage or engine damage.

The purity of DEF is essential to prevent malfunctions in the exhaust gas aftertreatment.

If DEF is pumped out of the DEF tank, e.g. during repair work, the same liquid must not be used to refill the tank. Its purity is no longer guaranteed.

Disposal

Observe country-specific laws and regulations when disposing of DEF.

♻ Environmental note

Dispose of DEF in an environmentally responsible manner.

DEF supply reservoir content

Depending on equipment, the DEF supply reservoir content may vary.

Tank contents

Diesel Exhaust Fluid (DEF)¹²

Approximately 3.2 US gal (12.0 l)¹³

Approximately 4.7 US gal (18.0 l)¹⁴

Approximately 4.9 US gal (18.5 l)¹³

Approximately 5.8 US gal (22.0 l)¹⁵

DEF consumption

For vehicles with a 4-cylinder, in-line engine (OM 651), the DEF consumption of the vehicle is:

- as Cargo Van/Passenger Van, approx. 2322 MPG (0.2 l/100 km)
- as Cab Chassis, approximately 1720 MPG (0.35 l/100 km)

For vehicles with a 6-cylinder, in-line engine (OM 642), the DEF consumption of the vehicle is:

- as Cargo Van/Passenger Van, approx. 2322 MPG (0.10 l/100 km)
- as Cab Chassis, approximately 1720 MPG (0.14 l/100 km)

In each case, the stated consumption figure is a mean value between urban and extra-urban driving cycles. The consumption figure does not refer to a specific vehicle, but is provided for the purposes of comparison between different vehicle types.

DEF consumption, like fuel consumption, is very dependent on the driving style and the operating conditions. This means that the real consumption figures during operation of your vehicle may deviate from those stated.

¹² DEF according to ISO 22241. Observe the MB Specifications for Service Products, Sheet 352.0.

¹³ Vehicles with an OM 642 engine)

¹⁴ Vehicles with an OM 651 engine)

¹⁵ Cab Chassis only.

Engine oil

General notes

! The bottles of the various engine oil types are marked with ACEA (Association des Constructeurs Européens d'Automobiles) and/or API (American Petroleum Institute) classifications. Only use approved engine oils that conform to the following MB Specifications for Service Products and the prescribed ACEA and/or API classifications. Using engine oils of another quality is not permitted and may invalidate the New Vehicle Limited Warranty.

The use of other, non-approved engine oils for diesel engines can cause damage to the diesel particle filter (DPF).

Use only engine oils that have been approved for your vehicle according to the MB Specifications for Service Products.

The MB Specifications for Service Products are valid for your vehicle¹⁶

- 228.51
- 229.31
- 229.51

These are high quality engine oils which have a positive effect on:

- engine wear
- fuel consumption
- exhaust gas emissions

Multi-grade engine oils of the prescribed SAE class (viscosity) may be used all year round, taking the outside temperatures into account.

Engine oil viscosity

! If the SAE viscosity class of the engine oil used does not cover the outside temperature range in which you are operating the vehicle, it must be changed in good time, in particular before the cold season commences. Using an engine oil that does not have

adequate temperature characteristics can lead to engine damage.

The temperature range information of the SAE classification always refers to that of fresh oil. The temperature characteristics of the engine oil may deteriorate significantly due to aging in use, especially at low outside temperatures.

We recommend that you change the engine oil before the cold season commences. Use an approved engine oil of the specified SAE class.

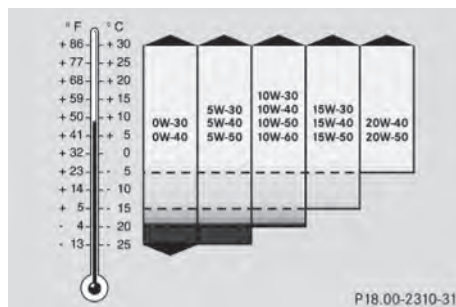

Engine oil SAE classification

Viscosity indicates the flow characteristics of a fluid. If an engine oil has a high viscosity, this means that it is thick; a low viscosity means that it is thin.

Depending on the respective outside temperatures, select an engine oil according to SAE classification (viscosity). The table displays the SAE classification to be used. The low temperature characteristics of engine oils can noticeably deteriorate during operation, e.g. from aging, soot and fuel accretion. For this reason, regular oil changes using an approved engine oil from the suitable SAE classification are urgently recommended.

Additives

! Do not use any additives in the engine oil. This could damage the engine.

¹⁶ If the quality grade is not available for diesel, you may also add engine oils meeting the requirements in MB Sheet No. 228.5, 229.3 or 229.5. The topping-up quantity is then limited to a maximum of 1 qt (1 l).

Miscibility of engine oils

! Mixing oils reduces the benefits of using high grade engine oils.

We recommend that you only add engine oil of the same quality grade and SAE class as used when the engine oil was last changed.

If, in exceptional cases, oil of the type in the engine is not available, top up using another approved mineral or synthetic engine oil.

If the quality grade is not available for diesel engines, you may also add engine oils meeting the requirements in MB Sheet Number 228.5, 229.3 or 229.5. The topping-up quantity is then limited to a maximum of 1 qt (1 l).

Engine oils are differentiated according to:

- engine oil brand
- quality grade (sheet number)
- SAE class (viscosity)

Subsequently have the engine oil changed at the earliest possible opportunity.

Interval for oil change

The on-board computer automatically shows the date for the next oil change as an event message in the display.

Only by using engine oil with a particularly high quality grade, e.g. according to Sheet Number 228.51 of the Mercedes-Benz Specifications for Service Products, can the maximum interval for oil change be achieved.

We recommend having the oil changed at a qualified specialist workshop.

Engine oil for diesel engines

Product name/number

see the Maintenance Booklet
MB Sheet Number 228.51, 229.31, 229.51

Capacities

! Do not add too much oil. adding too much engine oil can result in damage to the engine or to the catalytic converter. Have excess engine oil siphoned off.

Oil change including oil filter

Vehicles	Engine oil
210 CDI, 213 CDI, 216 CDI, 310 CDI, 313 CDI, 316 CDI, 510 CDI, 513 CDI, 516 CDI	Approximately 11.5 l
219 CDI, 319 CDI, 519 CDI	Approximately 12.5 l
216, 316, 516	Approximately 8.0 l

Information about oil consumption

! If the vehicle is predominantly used for short-distance driving, this could lead to a malfunction in the automatic cleaning function for the diesel particle filter. As a result, fuel may accumulate in the engine oil and cause engine failure.

Therefore, if you mainly drive short distances, you should drive on a highway or on rural roads for 20 minutes every 310 miles (500 km). This ensures sufficient regeneration of the diesel particle filter.

Depending on the driving style, the vehicle consumes a maximum of 1.0 US qt (1.0 l) of engine oil over a distance of 620 miles (1000 km).

Oil consumption may be higher if:

- the vehicle is new.
- you mainly operate the vehicle under arduous operating conditions.
- you frequently drive at high engine speeds.

Regular maintenance is one of the preconditions for moderate rates of consumption.

You can only estimate the oil consumption after you have driven a considerable distance.

Check the engine oil level on a regular basis, e.g. weekly or each time you refuel (> page 252).

Transmission and power steering oil**Automatic transmission****Service product: automatic transmission fluid**

Product name/number	Maintenance interval
Shell ATF 3403/M-115 MB Sheet No. 236.10	—
Fuchs/Shell ATF 3353 MB Sheet No. 236.12	—

Further information can be obtained at any qualified specialist workshop.

Rear axle**Service product: transmission oil**

Product name/number	Maintenance interval
BP Energear Hypo DC 80W-90 MB Sheet No. 235.20	—
Mobil Delvac Synthetic Gear Oil 75W-90 MB Sheet No. 235.8	—

Further information can be obtained at any qualified specialist workshop.

Steering**Service product: power steering fluid**

Product name/number	Maintenance interval
Mobil ATF-D, Exxon Mobil Corporation or equivalent MB Sheet No. 236.3	—

The steering is maintenance-free. Further information can be obtained at any qualified specialist workshop.

Brake fluid**⚠ WARNING**

Brake fluid is hazardous to health. Do not swallow brake fluid. See a doctor immediately if you swallow brake fluid.

Make sure that brake fluid does not come into contact with skin, clothing or eyes. Rinse affected areas with plenty of clean water and consult a doctor if necessary.

Always wear gloves and eye protection when topping up brake fluid.

Store brake fluid only in the original closed container and keep it out of the reach of children. Comply with safety regulations when handling brake fluid.

⚠ WARNING

The brake fluid constantly absorbs moisture from the air. This lowers the boiling point of the brake fluid. If the boiling point of the brake fluid is too low, vapor pockets may form in the brake system when the brakes are applied hard. This would impair braking efficiency. There is a risk of an accident.

You should have the brake fluid renewed at the specified intervals.

! Brake fluid corrodes paint, plastic and rubber. If paint, plastic or rubber has come into contact with brake fluid, rinse with water immediately.

Only use brake fluids approved for Sprinter vehicles. Always check for the identification DOT 4 plus.

Information about approved brake fluids can be found in the Maintenance Booklet or obtained at any qualified specialist workshop.

Service product: brake fluid	
Product name/ number	Intac B026E <ul style="list-style-type: none"> • Boiling point: 500 °F (260 °C) • Wet boiling point: 356 °F (180 °C)
MB Sheet No.	331.0
Maintenance interval	2 years

- i** Have the brake fluid renewed every 2 years at a qualified specialist workshop. There is usually a notice in the engine compartment to remind you when the next brake fluid change is due.

Coolant

Important safety notes

WARNING

If antifreeze comes into contact with hot components in the engine compartment, it may ignite. There is a risk of fire and injury.

Let the engine cool down before you add antifreeze. Make sure that antifreeze is not spilled next to the filler neck. Thoroughly clean the antifreeze from components before starting the engine.

- !** Take care not to spill any coolant on painted surfaces. You could otherwise damage the paintwork.

When handling, storing and disposing of coolant and antifreeze, please observe the relevant regulations and the safety notes in the "Service products and capacities" section (▷ page 320).

Coolant additive with corrosion/antifreeze protection

- !** Use only approved antifreeze/corrosion inhibitor that complies with MB Specification for Service Products, Sheet Number 325. Using other, non-approved antifreeze/corrosion inhibitors may cause damage to the coolant system and reduce the engine's service life.

Coolant is a mixture of water and antifreeze/corrosion inhibitor. It performs the following tasks:

- corrosion protection
- antifreeze protection
- raises the boiling point

When the vehicle is first delivered, it is filled with a coolant mixture that ensures adequate antifreeze and corrosion protection. Coolant must be used in the system all year round to ensure anti-corrosion protection and a raised boiling point – even in countries with high outside temperatures.

To prevent damage to the engine cooling system, use only approved corrosion inhibitor/antifreeze that comply with the Mercedes-Benz Specifications for Service Products. You will find information about approved corrosion inhibitor/antifreeze for your vehicle in the Maintenance Booklet.

We recommend corrosion inhibitor/antifreeze that meets the requirements in MB Specifications for Service Products Sheet Number 325.

Check the antifreeze/corrosion inhibitor concentration in the coolant every six months.

The percentage of corrosion inhibitor/antifreeze additive in the engine cooling system should:

- be at least 50%. This way, the engine cooling system is protected against freezing down to approximately -35 °F (-37 °C).
- not exceed 55% (antifreeze protection down to -49 °F [-45 °C]). Otherwise, heat will not be dissipated as effectively.

If there has been coolant loss, do not refill only with water. If the vehicle has lost coolant, add equal parts water and corrosion inhibitor/antifreeze additive. The water used as part of the coolant mixture must fulfill certain requirements; these are usually fulfilled by drinking water. If the water quality is not sufficient, you must treat the water.

Further information can be obtained at any qualified specialist workshop.

Service product: coolant

Product name/number
EURO Peak Coolant/Antifreeze, OLD WORLD INDUSTRIES MB Sheet No. 325.0
Zerex G05, The Valvoline Company MB Sheet No. 325.0
Zerex G48, The Valvoline Company MB Sheet No. 325.0
Glysantin G05, BASF AG MB Sheet No. 325.0

Capacities

Engine cooling system

Coolant	Approximately 10.75 US qt (10.0 l)
---------	---------------------------------------

Refrigerant

The air-conditioning system uses the refrigerant R-134a. This refrigerant does not damage the ozone layer.

Product name/number	Maintenance interval
Refrigerant R-134a MB Sheet No. 36 1.0	—

Further information can be obtained at any qualified specialist workshop.

Washer fluid

Important safety notes

WARNING

Windshield washer concentrate is highly flammable. If it comes into contact with hot engine components or the exhaust system it could ignite. There is a risk of fire and injury.

Make sure that no windshield washer concentrate is spilled next to the filler neck.

- Only use washer fluid that is suitable for plastic lamp lenses, e.g. MB SummerFit or MB WinterFit. Unsuitable washer fluid could damage the plastic lenses of the headlamps.

Observe also the safety notes in the "Service products and capacities" section.

Mixing ratio

Add windshield washer concentrate to the washer fluid all year round. Adapt the mixing ratio to the ambient temperature.

At temperatures above freezing:

- Fill up the washer fluid reservoir with a mixture of water and windshield washer concentrate, e.g. Summerwash to prevent smearing.

At temperatures below freezing:

- Fill up the washer fluid reservoir with a mixture of water and windshield washer concentrate, e.g. Winterwash if there is a danger of frost. This prevents washer fluid from freezing on the windshield.

Capacities

Windshield washer system with/without headlamp cleaning system

Washer fluid	Approx. 6.3 US qt (6.0 l)
--------------	---------------------------

Vehicle data

General notes

The following section contains important technical data for your vehicle. Your vehicle registration documents contain vehicle-specific and equipment-dependent technical data such as vehicle dimensions and vehicle weights.

Cargo tie-down points and carrier systems

Cargo tie-down points

General notes

! Observe the information on the maximum loading capacity of the individual cargo tie-down points.

If you use several cargo tie-down points to secure a load, you must always take the maximum loading capacity of the weakest cargo tie-down point into account.

If you brake hard, for example, the forces acting could be up to several times the weight force of the load. Always use multiple cargo tie-down points in order to distribute the force absorption. Load the anchorages evenly.

You will find further information about cargo tie-down points and cargo tie-down rings in the "Transporting" section (▷ page 244).

Cargo tie-down rings

The maximum tensile load of the cargo tie-down rings is:

Cargo tie-down rings	Permissible nominal tensile load
Passenger Vans	786.5 lbf (3500 N)
Cargo Van	1 124.0 lbf (5000 N)

Load rails

The maximum tensile loads of the cargo tie-down points in the cargo compartment are:

Cargo tie-down point	Permissible nominal tensile load
Load rails on cargo compartment floor	1 124.0 lbf (5000 N)
Lower load rail on sidewall	562.0 lbf (2500 N)
Upper load rail on sidewall	337.0 lbf (1500 N)

The values specified apply only to loads placed on the floor of the cargo compartment if:

- the load is secured to 2 cargo tie-down points on the rail and
- the distance to the nearest load-securing point on the same rail is approximately 3 ft (1 m).

Roof carrier

WARNING

When you load the roof, the center of gravity of the vehicle rises and the driving characteristics change. If you exceed the maximum roof load, the driving characteristics, as well as steering and braking, will be greatly impaired. There is a risk of an accident.

Never exceed the maximum roof load and adjust your driving style.

WARNING

If you distribute the load unevenly in the vehicle, the handling as well as the steering and braking characteristics are severely affected. There is a risk of an accident.

Distribute the load evenly in the vehicle. Secure the load to prevent it from slipping.

- ❗ The weight of any load carried on the roof, including the roof carrier, must not exceed the maximum permissible roof load.

The roof carrier supports must be mounted at equal distances.

We recommend that you have a stabilizer installed on the front axle.

- ❗ For safety reasons, we recommend that you only use roof carrier systems that have been tested and approved for the Sprinter. This will help to avoid damage.

The data is valid for a load distributed evenly over the entire roof area. Maximum roof load and minimum number of pairs of roof carrier supports on vehicles with:

	Maximum roof load	Minimum number of pairs of supports
Standard roof	660 lbs (300 kg)	6
High roof	330 lbs (150 kg)	3

Reduce the load on shorter roof carriers proportionately. The maximum load per pair of roof carrier supports is 110 lbs (50 kg).

Loading directions and other information concerning load distribution and load securing can be found in the "Transporting" section (> page 242).

Trailer tow hitch

General notes

We recommend that you have the trailer tow hitch mounted at an authorized Sprinter Dealer.

Use only a trailer tow hitch that has been tested and approved specially for your vehicle by the distributor named on the inside of the front cover. Only use a ball coupling that is approved for your vehicle and Sprinter trailer tow hitch. You can also find information on the permitted dimensions of the ball coupling on the identification plate of the trailer tow hitch.

You can obtain advice from a qualified specialist workshop. Also observe the information on towing a trailer in the "Driving and parking" section (> page 173).

Maximum permitted weights and loads

! On vehicles with a permissible gross vehicle weight of 11 030 lbs (5003 kg), the permissible gross combination weight is less than the total of the permissible gross vehicle weight and the permissible trailer load. Exceeding the permissible gross combination weight can lead to damage to the drivetrain, to the transmission or to the trailer tow hitch.

If the vehicle or the trailer is fully laden, the relevant value for the permissible gross vehicle weight or the permissible trailer load is therefore lower. In this case, the trailer or the vehicle may only be partially loaded.

The permissible weights and loads which cannot be exceeded can also be found:

- in your vehicle documents and
- on the identification plates of the trailer tow hitch, trailer and vehicle (▷ page 319).

You will find the basic values approved by the manufacturer in the following table. If the values differ, the lowest value applies.

Make sure that you adhere to the weight restrictions by having the weight checked on a calibrated weighbridge.

Vehicle type	Gross vehicle weight GVWR	Gross front axle load GAWR (FA)	Gross rear axle load GAWR (RA)	Gross combination weight ¹⁷ GCWR	Trailer load ¹⁸ GTW	Max. permissible nose weight TWR
2500	8550 lbs (3878 kg)	3970 lbs (1801 kg)	5360 lbs (2431 kg)	13550 lbs (6146 kg)	5000 lbs (2268 kg)	500 lbs (227 kg)
3500	9900 lbs (4490 kg) Canada only	4080 lbs (1851 kg)	7060 lbs (3202 kg)	14900 lbs (6759 kg) ¹⁹	5000 lbs (2268 kg) ¹⁹	500 lbs (227 kg) ¹⁹
		4410 lbs (2000 kg)		15250 lbs (6917 kg) ²⁰	7500 lbs (3402 kg) ²⁰	750 lbs (340 kg) ²⁰
	9990 lbs (4531 kg) USA only	4080 lbs (1851 kg)	7060 lbs (3202 kg)	14990 lbs (6799 kg) ¹⁹	5000 lbs (2268 kg) ¹⁹	500 lbs (227 kg) ¹⁹
		4410 lbs (2000 kg)		15250 lbs (6917 kg) ²⁰	7500 lbs (3402 kg) ²⁰	750 lbs (340 kg) ²⁰
11030 lbs (5003 kg)	4080 lbs (1851 kg)	7720 lbs (3502 kg)	15250 lbs (6917 kg)	5000 lbs (2268 kg) ¹⁹	500 lbs (227 kg) ¹⁹	
	4410 lbs (2000 kg)			7500 lbs (3402 kg) ²⁰	750 lbs (340 kg) ²⁰	

¹⁷ Maximum permissible gross weight of the vehicle and trailer.

¹⁸ Maximum permissible gross weight of the trailer.

¹⁹ Only for extra-long vehicles with an overall length of 289.2 in (7344 mm).

²⁰ Not for extra-long vehicles with an overall length of 289.2 in (7344 mm).

