



Sprinter

Operator's Manual



9065844908

Order no. 6462 7546 13 Part no. 906 584 49 08 Edition 07-15 MB

Sprinter



Mercedes-Benz

Symbols

WARNING





Warning notes make you aware of dangers which could pose a threat to your health or life, or to the health and life of others.

Environmental note

Environmental notes provide you with information on environmentally aware actions or disposal.

 Notes on material damage alert you to dangers that could lead to damage to your vehicle.

 These symbols indicate useful instructions or further information that could be helpful to you.

-  This symbol designates an instruction you must follow.
-  Several consecutive symbols indicate an instruction with several steps.
-  (▷ page) This symbol tells you where you can find further information on a topic.
-  ▷ ▷ This symbol indicates a warning or an instruction that is continued on the next page.

Display This text indicates a message on the display.

Registered trademarks

ESP[®] is a registered trademark of Daimler AG.

Vehicle distributor

Mercedes-Benz USA, LLC
One Mercedes Drive
Montvale, NJ 07645-0350
www.mbusa.com
www.mbsprinterusa.com
Customer Assistance Center:
1-877-762-8267

Mercedes-Benz Canada, Inc.
98 Vanderhoof Avenue
Toronto, ON M4G 4C9
www.mercedes-benz.ca
Customer Relations Department:
1-800-387-0100

Mercedes-Benz USA, LLC and Mercedes-Benz Canada Inc. are Daimler companies.
Canada only: "Authorized Sprinter Dealer" is defined as an authorized Mercedes-Benz Sprinter Dealer.

Publication details

Internet

Further information about Mercedes-Benz vehicles and about Daimler AG can be found on the following websites:

<http://www.mercedes-benz.com>

<http://www.mbusa.com> (USA only)

<http://www.mercedes-benz.ca> (Canada only)

Editorial office

You are welcome to forward any queries or suggestions you may have regarding this Operator's Manual to the technical documentation team at the address on the inside of the front cover.

© Mercedes-Benz USA, LLC

© Mercedes-Benz Canada, Inc.

Mercedes-Benz USA, LLC and Mercedes-Benz Canada Inc. are Daimler companies.

Not to be reprinted, translated, or otherwise reproduced, in whole or in part, without written permission.

Vehicle manufacturer

Daimler AG
Mercedesstraße 137
70327 Stuttgart
Germany

Welcome to the world of Mercedes-Benz

Before you first drive off, read the Operator's Manual carefully and familiarize yourself with your vehicle. Please adhere to the information and warning notes in this Operator's Manual for your own safety and to ensure a longer operating duration of the vehicle. Failure to observe the instructions may lead to damage to the vehicle or personal injury.

Vehicle damage caused by a failure to observe the instructions is not covered by the New Vehicle Limited Warranty.

The equipment or model designation of your vehicle may differ according to:

- model
- order
- country specification
- availability

The illustrations in this Operator's Manual show a left-hand-drive vehicle. The location of vehicle parts and controls for right-hand drive vehicles differ accordingly.

Mercedes-Benz is constantly updating its vehicles to the state of the art.

Mercedes-Benz reserves the right to introduce changes in:

- design
- equipment
- technology

Therefore, the descriptions provided may occasionally differ from your own vehicle.

The following are integral parts of the vehicle:

- Operator's Manual
- Maintenance or Service Booklet
- Service and warranty information
- Equipment-dependent operating instructions

Keep these documents in the vehicle at all times. Should you sell the vehicle, always pass the documents on to the new owner.

We wish you pleasant motoring at all times.

Index 3

Introduction 22

At a glance 31

Safety 39

Opening and closing 59

Seats, steering wheel and mirrors 72

Lights and windshield wipers 79

Climate control 97

Driving and parking 118

On-board computer and displays 161

Stowing and features 204

Transporting loads 212

Maintenance and care 218

Roadside Assistance 240

Wheels and tires 247

Technical data 275

- 1, 2, 3 ...**
- 4ETS (Electronic Traction System)** 55
- 12 V socket** 210
- A**
- ABS (Anti-lock Braking System)**
- Display message 181
 - Function/notes 53
 - Important safety notes 53
 - Indicator lamp 195
- Access step in the bumper**
- Cleaning 237
- Activating/deactivating cooling with air dehumidification** 102
- Activating/deactivating the roof ventilator** 117
- Adaptive Brake Assist**
- Function/notes 143
- ADAPTIVE ESP®**
- see ESP® (Electronic Stability Program)
- Add-on equipment** 27
- Additional indicators**
- Replacing bulbs 88
 - Replacing bulbs (roof) 91
- Additives**
- Diesel 279
 - Engine oil 281
- Adjusting the headlamp range** 81
- ADR (working speed governor)** 154
- Air bags**
- Deployment 45
 - Front air bag (driver, front passenger) 44
 - Important safety notes 43
 - Introduction 43
 - Side impact air bag 45
 - Window curtain air bag 45
- Air filter**
- Indicator lamp 201
- Air pressure**
- see Tire pressure
- Air vents**
- Adjusting for the passenger compartment 106
 - Adjusting on the roof 106
 - Important safety notes 105
 - Setting the center air vents 105
 - Setting the side air vents 106
- Air-conditioning system**
- Refrigerant 284
 - see Climate control
- Air-recirculation mode**
- Important safety notes 104
 - Switching on/off 104
- Alarm system**
- see ATA (Anti-Theft Alarm system)
- All-wheel drive**
- Engaging/disengaging 148
 - Important safety notes 147
 - LOW RANGE transmission ratio 148
- Anti-lock Braking System**
- see ABS (Anti-lock Braking System)
- Anti-Theft Alarm system**
- see ATA (Anti-Theft Alarm system)
- Anti-theft system**
- Interior motion sensor 57
- Armrests** 76
- Ashtray** 209
- ASR (acceleration skid control)**
- Activating/deactivating 53
 - Display message 182
 - Function/notes 53
 - Important safety notes 53
 - Indicator lamp 195
- ATA (Anti-Theft Alarm system)**
- Activating/deactivating 56
 - Switching off the alarm 56
- Authorized workshop**
- see Qualified specialist workshop
- Automatic car wash (care)** 233
- Automatic climate control**
- see Climate control
- Automatic headlamp mode** 80
- Automatic locking** 64
- Automatic transmission**
- Accelerator pedal position 126
 - Changing gear 125
 - Changing gear yourself 125
 - Driving tips 126
 - Emergency running mode 127
 - Important safety notes 124
 - Kickdown 126
 - Maneuvering 126

- Overview 124
 - Problem (malfunction) 127
 - Releasing the parking lock manually 127
 - Selector lever 124
 - Selector lever positions 124
 - Shift ranges 125
 - Starting the engine 120
 - Touchshift 125
 - Trailer towing 126
 - Transmission oil change 282
 - Automatic transmission emergency mode** 127
 - AUX port** 211
 - Auxiliary heater**
 - see Auxiliary warm-air heater
 - see Hot-water auxiliary heater
 - Auxiliary heating**
 - Activating/deactivating heater booster mode 111
 - Adjusting 173
 - Conditions for switching on 108
 - Heating time 107
 - Important safety notes 106
 - Operating with the button (control panel) 108
 - Operation with the remote control 109
 - Operation with the timer 114
 - Selecting a switch-on time 108
 - Setting the switch-on time 109
 - see Auxiliary heating
 - see Auxiliary warm-air heater
 - see Hot-water auxiliary heater
 - Auxiliary warm-air heater**
 - Problem (malfunction) 117
 - Axle load, permissible (trailer towing)** 287
- B**
- Backup lamps**
 - Replacing bulbs 89
 - Backup lamps (Chassis Cab)**
 - Replacing bulbs 90
 - BAS (Brake Assist System)**
 - Display message 182
 - Function/notes 54
 - Indicator lamp 195
 - Basic settings**
 - see Settings
 - Battery**
 - Isolating switch 118
 - Replacing (SmartKey) 61
 - Battery (SmartKey)**
 - Checking 61
 - Important safety notes 61
 - Replacing 61
 - Battery (vehicle)**
 - Care 232
 - Charge indicator lamp 198
 - Charging 232
 - Disconnecting and connecting 229
 - Disconnecting and connecting (engine compartment) 231
 - Display message 192
 - Important safety notes 227
 - Installing/removing (engine compartment) 231
 - Jump starting 242
 - Location 228
 - Removing and installing 230
 - Removing and installing the floor covering 228
 - Before driving off**
 - Important safety notes 120
 - Belt**
 - see Seat belts
 - Bleeding the fuel system** 123
 - Blind Spot Assist**
 - Activating/deactivating 146, 173
 - Notes/function 144
 - Trailer towing 146
 - Bottle holder**
 - see Cup holder
 - Brake Assist**
 - see BAS (Brake Assist System)
 - Brake Assist System**
 - see BAS (Brake Assist System)
 - Brake fluid**
 - Checking the level 223
 - Display message 183
 - Notes 283
 - Warning lamp 195

Brake force distribution, electronic

see EBD (electronic brake force distribution)

Brake lamps

Replacing bulbs 89

Brake lamps (Chassis Cab)

Replacing bulbs 90

Brake linings

Display message 182

Indicator lamp 198

Brake pads/linings

New 136

Brake system

Malfunction 182

Warning lamp 195

Brakes

ABS 53

Adaptive Brake Assist 143

Applying the parking brake 131

BAS 54

Brake fluid (notes) 283

Checking brake fluid level 223

Display messages 182

EBD 54

Important safety notes 135

Maintenance 195

New brake pads/linings 136

Parking brake (notes) 136

Riding tips 135

Breakdown

Fire extinguisher 242

First-aid kit 241

Jump-starting 242

Reflective safety jacket 241

Vehicle tool kit 240

Warning lamp 241

Warning triangle 241

see Flat tire

see Towing away

Bulb

see Changing bulbs

Bulb failure indicator 79

C**California**

Important notice for retail customers and lessees 22

Car

see Vehicle

Care

Access step in the bumper 237

Car wash 233

Display 237

Exterior lights 236

Interior 237

Notes 233

Paint 235

Plastic trim 238

Power washer 234

Rear view camera 236

Roof lining 238

Seat belt 238

Seat cover 238

Selector lever 238

Sensors 236

Sliding door 237

Steering wheel 238

Step (electrical) 237

Trim pieces 238

Washing by hand 234

Washing the engine 234

Wheels 235

Windows 235

Wiper blades 235

Cargo compartment

Activating/deactivating ventilation 117

Cargo compartment floor 28

Cargo tie-down points and tie downs

Important safety notes 214

Cargo tie-down rings

Installing 216

Permissible tensile load 285

Carrier system

Ladder rack 217

CD player/CD changer 168

Cell phone

see Mobile phone

Center console overview 35

- Central locking**
 - Automatic locking 64
 - Important safety notes 64
 - Locking/unlocking (buttons) 64
 - Locking/unlocking (SmartKey) 59
 - Locking/unlocking manually 64
- Central locking system**
 - see Central locking
- Changing bulbs**
 - Additional indicators (roof) 91
 - Additional turn signals 88
 - Backup lamp (Chassis Cab) 90
 - Backup lamps 89
 - Bi-Xenon bulbs 86
 - Brake lamps 89
 - Brake lamps (Chassis Cab) 90
 - Cornering lamps 87
 - Courtesy lights 91
 - Daytime running lamps (halogen headlamps) 87
 - Display message 185
 - Front interior light 92
 - High-beam headlamps 87
 - Interior light 92
 - Interior lighting 92
 - License plate lamp 90
 - License plate lamp (Chassis Cab) 90
 - Low-beam headlamps 87
 - Overview of lamp types (front bulbs) 86
 - Overview of lamp types (rear bulbs, Cargo Van/Passenger Van) 89
 - Overview of lamp types (rear bulbs, Chassis Cab) 90
 - Parking lamps 87
 - Perimeter lamp 90, 91
 - Rear fog lamp 89
 - Rear fog lamp (Chassis Cab) 90
 - Rear interior light 92
 - Standing lamps (rear, Chassis Cab) 90
 - Standing lamps (rear) 89
 - Tail lamps 89
 - Tail lamps (Chassis Cab) 90
 - Turn signals (front) 88
 - Turn signals (rear, Chassis Cab) 90
 - Turn signals (rear) 89
- Warning and indicator lamps 203
 - see Replacing bulbs
- Changing bulbs**
 - see Replacing bulbs
- Checklist**
 - Before driving off-road 138
- Child**
 - Restraint system 48
- Child seat**
 - Forward-facing restraint system 51
 - LATCH-type (ISOFIX) child seat anchors 49
 - On the front-passenger seat 51
 - Rearward-facing restraint system 51
 - Top Tether 50
- Child-proof locks**
 - Important safety notes 51
 - Rear door 52
- Children**
 - Special seat belt retractor 48
- Chock** 132
- Cigarette lighter** 209
- Cleaning**
 - Mirror turn signal 236
 - Trailer tow hitch 237
- Climate control**
 - Air conditioning in the rear compartment 101
 - Air-conditioning system 99
 - Auxiliary heating 106
 - Checking/cleaning the air filter (rear-compartment air conditioning) 225
 - Cooling with air dehumidification .. 102
 - Defrosting the windows 103
 - Heating 98
 - Heating in the rear compartment ... 100
 - Important safety notes 97
 - Operating the cargo compartment air vents 117
 - Overview of systems 97
 - Problem with the rear window defroster 104
 - Problems with the windshield heating 104
 - Rear-compartment air conditioning 101
 - Rear-compartment heating 100

- Reheat function (air dehumidification) 103
 - Setting the air distribution 102
 - Setting the air vents 105
 - Setting the airflow 102
 - Setting the temperature 102
 - Switching air-recirculation mode on/off 104
 - Switching on/off 101
 - Switching the rear window defroster on/off 104
 - Switching windshield heating on/off 104
 - Cockpit**
 - Overview 31
 - see Instrument cluster
 - COLLISION PREVENTION ASSIST**
 - Activating/deactivating the distance warning function 143
 - COMAND display**
 - Cleaning 237
 - Combination switch** 81
 - Communications equipment**
 - Operation 211
 - PND fittings 211
 - Ports 211
 - Type approval/frequency 275
 - Consumption statistics (on-board computer)** 174
 - Control panel**
 - Above the windshield 36
 - Center console 35
 - Climate control 35
 - Driver's door 37
 - Left and right side of the steering wheel 37
 - Conversions/equipment** 27
 - Coolant (engine)**
 - Adding 223
 - Checking the level 222
 - Display message 188
 - Displaying the temperature (on-board computer) 167
 - Filling capacity 284
 - Important safety notes 222
 - Cooling**
 - see Climate control
 - Cornering lamps**
 - Replacing bulbs 87
 - Cornering light function**
 - Function/notes 82
 - Courtesy lights**
 - Replacing bulbs 91
 - Crosswind driving assistance** 55
 - Cruise control**
 - Activating 141
 - Activation conditions 140
 - Cruise control lever 140
 - Deactivating 141
 - Display message 190
 - Driving system 140
 - Function/notes 140
 - Important safety notes 140
 - Problem (malfunction) 142
 - Resuming the stored speed 141
 - Setting a speed 141
 - Storing and maintaining current speed 141
 - Cup holder** 208
 - Center console 208
 - Cup holder**
 - see Cup holders
 - Cup holders** 208
 - Curtains (cleaning instructions)** 239
 - Customer Assistance Center (CAC)** 27
 - Customer Relations Department** 27
- D**
- Dashboard**
 - see Cockpit
 - Dashboard lighting**
 - see Instrument cluster lighting
 - Data**
 - see Technical data
 - Daytime running lamps**
 - Activating/deactivating (vehicles with steering wheel buttons) 171
 - Changing bulbs (halogen headlamps) 87
 - Switching on/off (switch) 79
 - Switching on/off (vehicles without steering wheel buttons) 164

- Dealership**
 - see Qualified specialist workshop
- Declarations of conformity** 26
- DEF (Diesel Exhaust Fluid)**
 - Refilling 129
- Delayed switch-off** 172
- Diagnostics connection**
 - Operating safety and vehicle approval 26
- Diesel** 278
- Diesel engine**
 - Preglow indicator lamp 201
- Diesel Exhaust Fluid (DEF)**
 - Display messages (vehicles with steering wheel buttons) 187
 - Display messages (vehicles without steering wheel buttons) 178
 - Indicator lamp 197
 - Level indicator 162
 - Notes 279
 - Storage 280
 - Tank content 280
- Diesel particle filter**
 - Display message 187
 - Indicator lamp 201
 - Short-distance driving 134
- Digital speedometer**
 - Setting the unit (vehicles with steering wheel buttons) 169
- Display**
 - Display messages 176
 - Outside temperature (vehicles with steering wheel buttons) 167
 - Outside temperature display (vehicles without steering wheel buttons) 163
 - Standard display (vehicles with steering wheel buttons) 167
 - Standard display (vehicles without steering wheel buttons) 163
 - see Warning and indicator lamps
- Display message (vehicle with steering wheel buttons)**
 - Service interval display 226
- Display message (vehicle without steering wheel buttons)**
 - Service interval display 226
- Display messages**
 - Calling up the message memory 176
 - Driving systems 190
 - Engine 187
 - Important safety notes 176
 - Lights 185
 - Safety systems 181
 - SmartKey 193
 - Tires 191
 - Vehicle 192
- Distance recorder** 167
 - see Odometer
 - see Trip odometer
- Distance warning function**
 - Activating/deactivating 143
 - Function/notes 142
 - Warning lamp 143
- Door lock**
 - see Central locking
- Doors**
 - Central locking/unlocking (SmartKey) 59
 - Control panel 37
 - Display message 193
 - Indicator lamp 203
- Drinking and driving** 133
- Drinks holder**
 - see Bottle holder
- Driver's seat**
 - see Seats
- Driver's/front-passenger door**
 - Unlocking 65
- Driving abroad** 134
- Driving off-road**
 - see Off-road driving
- Driving on flooded roads** 136
- Driving on rough terrain**
 - Checklist before driving off-road 138
- Driving safety systems**
 - 4ETS (Electronic Traction System) 55
 - ABS (Anti-lock Braking System) 53
 - Adaptive Brake Assist 143
 - ASR (Acceleration Skid Control) 53
 - BAS (Brake Assist System) 54
 - Distance warning function 142
 - EBD (electronic brake force distribution) 54

- ESP® (Electronic Stability Program) 54
- Important safety information 52
- Overview 52
- Driving systems**
- Blind Spot Assist 144
- Cruise control 140
- Display message 190
- Lane Keeping Assist 146
- PARKTRONIC 151
- Driving tips**
- Automatic transmission 126
- Brakes 135
- Break-in period 118
- Downhill gradient 135
- Drinking and driving 133
- Driving abroad 134
- Driving in winter 137
- Driving on flooded roads 136
- Driving on wet roads 136
- Exhaust check 134
- Fuel 133
- General 133
- Hydroplaning 136
- Icy road surfaces 137
- Important safety notes 118
- Limited braking efficiency on salted roads 136
- New brake disks 136
- New brake pads/linings 136
- Off-road driving 137
- Overrun cut-off 133
- Snow chains 249
- Speed limitation 134
- Towing a trailer 155
- Transport by rail 135
- Wet road surface 136
- DSR (Downhill Speed Regulation) 149**
- E**
- EBD (electronic brake force distribution)**
- Display message 183
- Function/notes 54
- Indicator lamps 195
- Electrical closing assist 66**
- Electrical fuses**
- see Fuses
- Electrical step**
- Cleaning 237
- Display message 192
- Emergency release 67
- Function 67
- Important safety notes 66
- Indicator lamp 203
- Manual retraction 67
- Obstacle detection 67
- Electrical system**
- Battery main switch 118
- Electronic brake force distribution**
- see EBD (electronic brake force distribution)
- Electronic Stability Program**
- see ESP® (Electronic Stability Program)
- Electronic Traction System**
- see 4ETS (Electronic Traction System)
- Emergency exit 55**
- Emergency exit window 55**
- Emergency Tensioning Devices**
- Activation 45
- Emissions control**
- Service and warranty information 22
- Engine**
- ADR (working speed governor) 154
- Changing the power output 26
- Check Engine warning lamp 200
- Cleaning instructions 234
- Engine number 277
- Engine speed setting (working mode) 155
- Irregular running 123
- Jump-starting 242
- Operating safety 26
- Starting 120
- Starting problems 123
- Switching off 132
- Tow-starting (vehicle) 246
- Engine electronics**
- Notes 275
- Problem (malfunction) 123
- Engine oil**
- Adding 222
- Additives 281

- Checking the oil level (on-board computer) 220
- Checking the oil level using the dipstick 221
- Display message 190
- Filling capacity 282
- Information about oil consumption 282
- Mixing 281
- Notes about oil grades 280
- Oil change 282
- Oil level (note) 220
- Viscosity 281
- Warning lamp 198
- Engine speed setting (working mode)** 154
- Engine, jump-starting** 242
- ESP® (Electronic Stability Program)**
- Display message 184
- Important safety information 54
- Indicator lamp 197
- Warning lamp 194
- Exhaust check** 134
- Exhaust gas aftertreatment**
- DEF level indicator 162
- DEF reducing agent 279
- Diesel Exhaust Fluid (DEF) 279
- Display messages (vehicles with steering wheel buttons) 187
- Display messages (vehicles without steering wheel buttons) 178
- Indicator lamp 197, 201
- Malfunction 188
- Refilling DEF 129
- Exterior lighting**
- see Lights
- Exterior mirrors**
- Adjusting 78
- Important safety notes 78
- Eyeglasses compartment** 205
- F**
- Fire extinguisher** 242
- First-aid kit** 241
- Flat tire**
- Changing a wheel/mounting the spare wheel 267
- General notes 266
- Fog lamps**
- Switching on/off 80
- Fogged-up windows**
- see Climate control
- Folding seat** 74
- Frequencies**
- Mobile phone 275
- Two-way radio 275
- Front fog lamps**
- Switching on/off 80
- Front interior light**
- Replacing bulbs 92
- Front windshield**
- see Windshield
- Fuel**
- Additives (diesel) 279
- Consumption information 279
- Consumption statistics 174
- Diesel at very low outside temperatures 278
- Display message 189
- Driving tips 133
- Fuel gauge 162
- Problem (malfunction) 129
- Quality (diesel) 278
- Refueling 127
- Showing the range (on-board computer with steering wheel buttons) 174
- Showing the range (vehicles with steering wheel buttons) 174
- Tank content/reserve fuel 278
- Fuel filter with water separator**
- draining 224
- Indicator lamp 202
- Fuel gauge** 162
- Fuel tank**
- Problem (malfunction) 129
- Fuel tank content**
- Reserve, display message 189
- Fuses** 246

G

Gasoline	
Reserve fuel warning lamp	200
General driving tips	
Driving short distances	134
Genuine parts	28
Glove box	204
GTW (Gross Trailer Weight) (definition)	264

H

Handbrake	
see Parking brake	
Hazard warning lamps	82
Head restraints	
Adjusting	76
Adjusting (rear)	76
Headlamps	
Adding fluid to cleaning system	224
Cleaning system (function)	82
Fogging up	83
see Automatic headlamp mode	
Headliner (cleaning instructions)	238
Heating	
see Climate control	
High-beam headlamps	
Highbeam Assist	83
Replacing bulbs	87
Switching on/off	81
Highbeam Assist	
Function/notes	83
Switching Highbeam Assist on/off	171
Hood	
Closing	219
Display message	192
Important safety notes	218
Indicator lamp	203
Opening	218
Hot-water auxiliary heater	
Problem (malfunction)	113
Hydroplaning	136

I

Ignition lock	
see Key positions	

Immobilizer	56
Indicator lamp	
see Warning and indicator lamps	
Indicators	
see Turn signals	
Insect protection on the radiator	28
Installing a wheel	
Installing the adapter (spare wheel)	269
Instrument cluster	
Fuel gage	162
Important safety notes	161
Instrument cluster lighting	162
Outside temperature display	162
Overview	32
Speedometer	162
Tachometer	162
Warning and indicator lamps	33
Instrument cluster lighting	162

Instrument lighting	
see Instrument cluster lighting	
Interior lighting	84
Front	84
Motion detectors	85
Notes on replacing bulbs	92
Overview	84
Replacing bulbs	92
Switching the rear compartment lighting on centrally	84
Interior motion sensor	
Arming	57
Deactivating	58
Function	57
Switching off	57

J

Jack	
Jacking points	268
Preparation	268
Storage location	240
Using	268
Jump-starting	242

K

Key	
Position in the ignition lock	119

- Key positions** 119
- Kickdown** 126
- L**
- Lamps**
see Warning and indicator lamps
- Lane Keeping Assist**
Activating/deactivating 147
Function/notes 146
- Language**
Display (vehicles with steering wheel buttons) 170
- Lashing points and tie downs**
Permissible tensile load 285
- LATCH-type (ISOFIX) child seat anchors** 49
- License plate lamp**
Replacing bulbs 90
- License plate lamp (Chassis Cab)**
Replacing bulbs 90
- Light sensor** 80
- Lighting**
see Lights
- Lights**
Activating/deactivating daytime running lamps (on-board computer with steering wheel buttons) 171
Activating/deactivating surround lighting (vehicles with steering wheel buttons) 172
Automatic headlamp mode 80
Bulb failure indicator 79
Cornering light function 82
Driving abroad 135
Fog lamps 80
Hazard warning lamps 82
Headlamp range 81
High beam flasher 81
High-beam headlamps 81
Highbeam Assist 83
Important safety notes 79
Light switch 79
Low-beam headlamps 79
Parking lamps 79
Rear fog lamp 80
Setting the exterior lighting delayed switch-off (vehicles with steering wheel buttons) 172
Switching the daytime running lamps on/off (switch) 79
Turn signals 81
see Changing a bulb
see Interior lighting
- Limited Warranty** 22
- Load distribution** 214
- Load securing aids**
Carrier systems 216
- Loading guidelines**
Important safety notes 212
- Loading rails**
Installing cargo tie-down rings 216
Maximum tensile strength 285
- Loads**
Securing 214
Transporting 212
- Locator lighting**
Setting (vehicles with steering wheel buttons) 172
- Locking**
see Central locking
- Locking and unlocking manually** 64
- Locking centrally**
see Central locking
- LOW RANGE** 148
- LOW RANGE transmission ratio** 148
- Low-beam headlamps**
Display message 185
Driving abroad 135
Replacing bulbs 87
Switching on/off 79
- Lumbar support** 73
- M**
- M+S tires** 249
- Maintenance** 225
- Malfunctions**
Message memory (on-board computer) 176
- Maximum speed**
Speed limitation 134

Menu (vehicles with steering wheel buttons)

Audio	167
Operation	166
Settings	168
Telephone	175

Message

see Display message

Message memory (on-board computer) 176**Mirrors**

Exterior mirrors	78
Rear-view mirror	78

Mobile navigation devices 211**Mobile phone** 211

Important safety notes	210
Pre-installation	210
Type approval/frequency	275

Mounting wheels

Lowering the vehicle	271
Mounting a new wheel	270
Preparing the vehicle	267
Raising the vehicle	268
Removing a wheel	269
Removing and mounting the spare wheel	273
Securing the vehicle against rolling away	267

N**Navigation**

Fittings for PND mobile navigation devices	211
--	-----

Notes on breaking-in a new vehicle 118**O****Occupant safety**

Children in the vehicle	47
Important safety notes	39
Introduction to the restraint system	39
Pets in the vehicle	52
Restraint system warning lamp	39

Odometer

Display (vehicles with steering wheel buttons)	167
Display (vehicles without steering wheel buttons)	163

Off-road driving

Checklist after driving off-road	139
Important safety notes	137
Rules for driving off-road	139

Oil

see Engine oil

On-board computer

Checking the oil level	220
Display message	176
Lighting submenu	171

On-board computer (vehicles with steering wheel buttons)

Audio menu	167
Display message	164
Menu overview	166
Operating	164
Operation menu	166
Settings menu	168
Standard display	167
Telephone menu	175
Trip computer menu	174

On-board computer (vehicles without steering wheel buttons)

Display message	176
General notes	163
Setting the clock	164
Standard display	163

Operating Instructions

Before the first journey	22
Limited Warranty	22

Operating safety

Limited Warranty	22
------------------------	----

Operating safety and vehicle approval

Attachments and bodies	27
Changing the engine power output	26
Correct use	24
Declaration of conformity	26
Equipment and conversions	27
Important safety notes	25
Information about body/equipment mounting directives	27

- Notes on operating the vehicle 25
 Qualified specialist workshop 26
 Registering your vehicle 27
- Operating system**
 see On-board computer
- Operator's Manual**
 General notes 22
 Vehicle equipment 22
- Outline lamp**
 Replacing bulbs 91
- Outside temperature display** 162
- Overhead control panel** 36
- Overrevving range** 162
- Overrun cutoff** 133
- P**
- Paintwork (cleaning instructions)** ... 235
- Paper holder** 207
- Parking** 130
 Important safety notes 130
 Parking brake 131
 Wheel chock 132
 see PARKTRONIC
- Parking aid**
 see PARKTRONIC
- Parking assistance**
 see PARKTRONIC
- Parking brake**
 Display message 184
 Notes/function 131
- Parking lamps**
 Replacing bulbs 87
- PARKTRONIC**
 Deactivating/activating 153
 Driving system 151
 Function/notes 151
 Important safety notes 151
 Problem (malfunction) 154
 Range of the sensors 151
 Roll-back warning 153
 Trailer towing 153
 Warning display 152
- Partition sliding door**
 Important safety notes 70
 Opening/closing 70
- Passenger compartment air-conditioning system**
 see Climate control
- Passenger compartment heating**
 see Climate control
- Perimeter lamp**
 Replacing bulbs 90
- Pets in the vehicle** 52
- Plastic trim (cleaning instructions)** 238
- Power assistance for the steering**
 Display message 192
 Warning lamp 203
- Power supply**
 Battery isolating switch 118
 Switching off 119
 Switching on 119
- Power take-off**
 Engine speed setting 154
- Power washers** 234
- Power windows**
 see Side windows
- Preparing for a journey**
 Checks in the vehicle 120
 Visual check of the vehicle exterior 120
- Protection of the environment**
 General notes 24
- Pulling away** 121
- Q**
- QR code**
 Rescue card 29
- Qualified specialist workshop** 26
- R**
- Radiator cover** 28
- Radio**
 Changing stations (vehicles with steering wheel buttons) 167
 see separate operating instructions
- Radio-wave reception/transmission in the vehicle**
 Declaration of conformity 26

- Rain and light sensor**
 Setting the sensitivity (vehicles with steering wheel buttons) 173
 Windshield wiper 93
- Range (vehicles with steering wheel buttons) 174**
- Rear bench seat**
 Installing/removing (Passenger Van) 75
 Stowage compartment (crewcab) .. 207
- Rear compartment**
 Activating/deactivating climate control 101
 Setting the air vents 106
- Rear door**
 Child-proof locks 52
 Important safety notes 68
 Opening/closing 68
 Opening/closing from inside 69
- Rear fog lamp**
 Replacing bulbs 89
 Switching on/off 80
- Rear fog lamp (Chassis Cab)**
 Replacing bulbs 90
- Rear interior light**
 Replacing bulbs 92
- Rear lamps**
 see Lights
- Rear rack**
 Notes 216
- Rear view camera**
 Cleaning instructions 236
 Important safety notes 154
 Switching on 154
- Rear window defroster**
 Problem (malfunction) 104
 Switching on/off 104
- Rear window wiper** 94
 Switching on/off 94
- Rear-compartment air-conditioning system**
 see Climate control
- Rear-compartment heating**
 see Climate control
- Rear-view mirror**
 Anti-glare mode 78
- Refilling**
 DEF filler neck 129
- Important safety notes (Diesel Exhaust Fluid - DEF) 129
 Refilling procedure (Diesel Exhaust Fluid - DEF) 129
- Refrigerant** 284
- Refueling**
 Fuel filler flap 128
 Fuel gauge 162
 Important safety notes (fuel) 127
 Refueling procedure (fuel) 128
 see Fuel
- Releasing the parking lock manually (automatic transmission) 127**
- Remote control**
 Changing the operating duration (auxiliary heating) 110
 Replacing the battery (auxiliary heating) 111
 Switching on/off (auxiliary heating) 110
 Synchronizing (auxiliary heating) ... 110
- Replacing bulbs**
 Important safety notes 86
- Replacing the battery (auxiliary heating remote control) 111**
- Replacing the fuel filter** 202
- Reporting safety defects** 27
- Rescue card** 29
- Restraint system**
 Introduction 39
 Warning lamp (function) 39, 198
- Reverse warning feature** 122
- Roadside Assistance (breakdown) 23**
- Roof carrier**
 Maximum payload 286
 Notes 216
- Roof load (roof carrier) 286**

S

Safety

- Children in the vehicle 47
 Operating safety 25

Safety system

- see Driving safety systems

Seat belts

- Adjusting the height 42
 Cleaning 238

- Correct usage 41
- Display message 184
- Fastening 42
- Important safety guidelines 40
- Introduction 40
- Releasing 42
- Warning lamp 203
- Warning lamp (function) 43
- Seat heating** 76
- Seats**
 - Adjusting lumbar support 73
 - Adjusting the front-passenger seat 73
 - Adjusting the head restraint 76
 - Armrest 76
 - Cleaning the cover 238
 - Correct driver's seat position 72
 - Folding seat 74
 - Important safety notes 72
 - Rear bench seat 75
 - Seat heating 76
 - Setting the driver's seat 73
 - Swivel seat 73
 - Twin front-passenger seat 74
- Securing loads**
 - Important safety notes 214
- Selector lever**
 - Cleaning 238
- Sensors (cleaning instructions)** 236
- Service center**
 - see Qualified specialist workshop
- Service interval display**
 - Calling up the service due date 226
 - Exceeding a service due date 226
 - Notes 226
 - Service due date (automatic display) 226
- Service products**
 - Brake fluid 283
 - Coolant (engine) 283
 - Diesel Exhaust Fluid (DEF) 279
 - Engine oil 280
 - Fuel 277
 - Important safety notes 277
 - Power steering fluid 283
 - Refrigerant 284
 - Transmission oil 282
 - Washer fluid 284
- Setting the air distribution** 102
- Setting the airflow** 102
- Setting the clock**
 - Vehicles with steering wheel buttons 171
 - Vehicles without steering wheel buttons 164
- Settings**
 - Resetting all (vehicles with steering wheel buttons) 168
 - Resetting submenus (vehicles with steering wheel buttons) 168
- Short journeys (diesel particle filter)** 134
- Side impact air bag** 45
- Side windows**
 - Cleaning 235
 - Hinged side windows 70
 - Important safety information 70
 - Opening/closing 71
 - Overview 70
 - Problem (malfunction) 71
 - Resetting 71
- Sliding door**
 - Cleaning 237
 - Closing assist 66
 - Important safety notes 65
 - Opening/closing 65
 - Opening/closing from the inside 66
 - Opening/closing from the outside 66
- SmartKey**
 - Changing the battery 61
 - Changing the locking system settings 173
 - Checking the battery 61
 - Display message 193
 - Door central locking/unlocking 59
 - Important safety notes 59
 - Loss 63
 - Problem (malfunction) 63
- SmartKey positions (ignition lock)** .. 119
- Snow chains** 249
- Sockets** 210
- Spare wheel**
 - General notes 273
 - Important safety notes 272

- Removing/mounting 273
 - Special seat belt retractor** 48
 - Specialist workshop** 26
 - Speed, controlling**
 - see Cruise control
 - Speedometer**
 - Digital (vehicles with steering wheel buttons) 170
 - Digital (vehicles without steering wheel buttons) 163
 - Selecting display unit (vehicles with steering- wheel buttons) 170
 - see Instrument cluster
 - Standing lamps**
 - Replacing bulbs 87
 - Replacing bulbs (rear) 89
 - Starting lamps (Chassis Cab)**
 - Replacing bulbs (rear) 90
 - Start-off assist**
 - Display message 182
 - Starting (engine)** 120
 - Station**
 - see Radio
 - Steering wheel**
 - Adjusting 77
 - Button overview 35
 - Cleaning 238
 - Step**
 - see Electrical step
 - Stickers**
 - General safety notes 24
 - Stowage spaces**
 - see Stowage spaces and stowage compartments
 - Stowage spaces and stowage compartments**
 - Eyeglasses compartment 205
 - Glove box 204
 - Important safety notes 204
 - Paper holder 207
 - Stowage compartment above the windshield 206
 - Stowage compartment in the center console 206
 - Stowage compartment in the dashboard 205
 - Stowage space above the headliner 206
 - Stowage space under the rear bench seat 207
 - Stowage space under the twin co-driver's seat 206
 - Summer tires** 249
 - Switch unit**
 - see Control panel
 - Switching off the alarm (ATA)** 56
 - Switching the heater booster function on/off** 111
 - Switching the surround lighting on/off (on-board computer)** 172
 - Swivel seat** 73
- T**
- Tachometer** 162
 - Tail lamps**
 - Changing 90
 - Replacing bulbs 89
 - see Lights
 - Tail lamps (Chassis Cab)**
 - Replacing bulbs 90
 - Tank content**
 - Fuel gauge 162
 - Range (vehicles with steering wheel buttons) 174
 - Reserve fuel warning lamp 200
 - Technical data**
 - Capacities 277
 - Cargo tie-down points 285
 - Cargo tie-down rings 285
 - Loading rails 285
 - Roof carrier 286
 - Tires/wheels 257, 272
 - Trailer tow hitch 286
 - Vehicle data 285
 - Telephone** 210, 211
 - Telephone (on-board computer)**
 - Accepting an incoming call 175
 - Display messages 193
 - Numbers from the phone book 175
 - Operating 175
 - Redialing 176
 - Rejecting or ending a call 175
 - Temperature**
 - Outside temperature 162
 - Setting (climate control) 102

- Setting the unit (vehicles with steering wheel buttons) 169
- Theft deterrent systems**
- Immobilizer 56
- Tow-away alarm 57
- Tightening torques for wheel nuts/ wheel bolts** 271
- Time**
- Setting the time (vehicles with steering wheel buttons) 171
- Setting the time (vehicles without steering wheel buttons) 164
- Timer**
- Activating 115
- Auxiliary heating 114
- Important safety notes 114
- Overview 114
- Setting the heating level (auxiliary heating) 116
- Setting the preselection time (auxiliary heating) 115
- Setting weekday, time and operating duration (auxiliary heating) ... 115
- Switching immediate heating mode on/off (auxiliary heating) 115
- Tire pressure**
- Calling up (on-board computer) 253
- Checking manually 253
- Display messages (vehicles with steering wheel buttons) 191
- Display messages (vehicles without steering wheel buttons) 178
- Maximum 252
- Notes 251
- Recommended 250
- Setting the unit (vehicles with steering wheel buttons) 170
- Tire label 251
- Tire pressure loss warning system** .. 255
- Tire pressure monitor**
- Checking the tire pressure electronically 254
- Display message 191
- Function/notes 253
- Indicator lamp 202
- Restarting 255
- Warning lamp 255
- Tire pressure table** 257
- Tires**
- Aspect ratio (definition) 265
- Average weight of the vehicle occupants (definition) 264
- Bar (definition) 264
- Changing a wheel 266
- Characteristics 264
- Checking 248
- Curb weight (definition) 265
- Definition of terms 264
- Direction of rotation 267
- Distribution of the vehicle occupants (definition) 266
- DOT (Department of Transportation) (definition) 264
- DOT, Tire Identification Number (TIN) 263
- GAWR (Gross Axle Weight Rating) (definition) 264
- GTW (Gross Trailer Weight) (definition) 264
- GVW (Gross Vehicle Weight) (definition) 264
- GVWR (Gross Vehicle Weight Rating) (definition) 265
- Important safety notes 247
- Increased vehicle weight due to optional equipment (definition) 264
- Kilopascal (kPa) (definition) 265
- Labeling (overview) 261
- Load bearing index (definition) 266
- Load index 263
- Load index (definition) 265
- M+S tires 249
- Maximum load on a tire (definition) 265
- Maximum loaded vehicle weight (definition) 265
- Maximum permissible tire pressure (definition) 265
- Maximum tire load 263
- Maximum tire load (definition) 265
- Optional equipment weight (definition) 265
- PSI (pounds per square inch) (definition) 265
- Replacing 266
- Service life 248

- Sidewall (definition) 265
- Snow chains 249
- Speed rating (definition) 264
- Storing 267
- Structure and characteristics (definition) 264
- Summer tires 249
- TIN (Tire Identification Number) (definition) 265
- Tire bead (definition) 265
- Tire pressure (definition) 265
- Tire pressures (recommended) 264
- Tire size (data) 257, 272
- Tire size designation, load-bearing capacity, speed rating 261
- Tire tread 248
- Tire tread (definition) 265
- Total load limit (definition) 266
- Traction (definition) 266
- TWR (permissible trailer drawbar noseweight) (definition) 266
- Uniform Tire Quality Grading Standards (definition) 264
- Wear indicator (definition) 266
- Wheel rim (definition) 264
- Top Tether** 50
- Touchshift (automatic transmission)** 125
- Tow-away alarm**
 - Arming/deactivating 57
 - Deactivating 57
 - Operation 57
- Tow-starting**
 - Emergency engine starting 246
 - Important safety notes 243
- Towing**
 - If the vehicle is stuck 245
 - Installing/removing the towing eye 244
 - With a raised front or rear axle 245
- Towing a trailer**
 - Axle load, permissible 287
 - Cleaning the trailer tow hitch 237
 - Coupling up a trailer 157
 - Decoupling a trailer 159
 - Driving tips 155
 - Important safety notes 155
 - Notes on retrofitting 286
 - Trailer loads 287
- Towing away**
 - Important safety guidelines 243
 - In the event of malfunctions 244
 - With both axles on the ground 245
- Trailer**
 - Brake force booster malfunction ... 195
- Trailer coupling**
 - see Towing a trailer
- Trailer loads and drawbar nose-weights** 159
- Trailer towing**
 - Blind Spot Assist 146
 - PARKTRONIC 153
 - Permissible trailer loads and drawbar noseweights 159
- Transmission**
 - see Automatic transmission
- Transmission oil** 282
- Transport**
 - Loading guidelines 212
 - Vehicle 246
- Transport by rail** 135
- Transportation**
 - Rail 135
- Transporting**
 - Load distribution 214
 - Securing a load 214
- Trim pieces (cleaning instructions)** 238
- Trip computer (on-board computer)** 174
- Trip meter**
 - see Trip odometer
- Trip odometer**
 - Display (vehicles with steering wheel buttons) 167
 - Display (vehicles without steering wheel buttons) 163
 - Resetting 162
 - see Trip computer (on-board computer)
- Turn signals**
 - Replacing bulbs (front) 88
 - Replacing bulbs (rear) 89
 - Switching on/off 81
- Turn signals (Chassis Cab)**
 - Replacing bulbs (rear) 90

Twin front-passenger seat	
Stowage compartment	206
Two-way radios	
Type approval/frequency	275
TWR (Tongue Weight Rating) (definition)	266

U

Unlocking	
From inside the vehicle (central unlocking button)	64
USB port	211

V

Vehicle	
Data acquisition	29
Display message	192
Electronics	275
Equipment	22
Individual settings (vehicles with steering wheel buttons)	168
Limited Warranty	22
Loading	258
Locking (SmartKey)	59
Lowering	271
Maintenance	23
Operating safety	25
Parking for a long period	132
Pulling away	121
Raising	268
Registration	27
Reporting problems	27
Securing from rolling away	130
Towing away	243
Transporting	246
Unlocking (SmartKey)	59
Vehicle battery	
see Battery (vehicle)	
Vehicle bodies	27
Body/equipment mounting directives for trucks	27
Vehicle data	285
Vehicle identification number	276
Vehicle identification plate	276
Vehicle tool kit	240

Vents

see Air vents

Voltage supply

Fuses

246

W

Warning

Stickers

24

Warning and indicator lamp

Diesel particle filter

201

Power assistance for the steering ..

203

Warning and indicator lamps

Brakes

195

Check Engine

200

Coolant

199

Diesel Exhaust Fluid (DEF)

197

Electrical step

203

ESP®

194

ESP® function

197

Overview

33

Seat belt

203

Warning lamp

241

Warning triangle

241

Warning- and indicator lamps

ABS

195

Air filter

201

ASR

194

BAS

195

Battery charge

198

Brake wear

198

Bulbs

203

Doors

203

Engine oil level

198

Preglow

201

Reserve fuel

200

Tire pressure monitor

202

Water separator

202

Windshield washer fluid

202

Warranty

22

Washer fluid

Adding

224

Capacities

285

Display message

193

Indicator lamp

202

Notes

284

Wiping with

93

Wheels

Changing a wheel	266
Checking	248
Cleaning	235
Important safety notes	247
Installing the adapter (spare wheel)	269
Interchanging/changing	266
Mounting a new wheel	270
Mounting a wheel	267
Removing a wheel	269
Removing and mounting the spare wheel	273
Snow chains	249
Storing	267
Tightening torque	271
Wheel size/tire size	272

Window curtain air bag	45
-------------------------------------	----

Windows

see Side windows

Windshield

Cleaning	235
Defrosting	103

Windshield heating

Problem (malfunction)	104
Switching on/off	104

Windshield washer fluid

Adding	224
Indicator lamp	202

Windshield wipers

Problem (malfunction)	96
Rain and light sensor	93
Rear window wiper	94
Replacing the wiper blades	94
Setting the sensitivity (vehicles with steering wheel buttons and rain/light sensor)	173
Switching on/off	93
Wiping with windshield washer fluid	93

Winter diesel	278
----------------------------	-----

Winter driving

Slippery road surfaces	137
Snow chains	249

Winter operation

General notes	249
Radiator cover	28

Winter tires

M+S tires	249
Setting a limit speed	134

Wiper blades

Cleaning	235
Replacing	94

Workshop

see Qualified specialist workshop

Operator's Manual

Before the first journey

These instructions, the Maintenance or Service Booklet and the additional equipment-specific instructions are integral parts of the vehicle. Keep these documents in the vehicle at all times. If you sell the vehicle, always pass on all documents to the new owner.

Before you first drive off, read these documents carefully and familiarize yourself with your vehicle.

For your own safety and a longer vehicle life, follow the instructions and warning notices in these Operating Instructions. Failure to observe the instructions may lead to damage to the vehicle or personal injury.

Vehicle damage caused by a failure to observe the instructions is not covered by the New Vehicle Limited Warranty.

Limited warranty

I Follow the instructions in this Operator's Manual about the proper operation of your vehicle as well as about possible vehicle damage. Damage to your vehicle that arises from culpable contravention of these instructions is not covered by the Limited Warranty of the distributor named on the inside of the front cover.

Vehicle equipment

The Operating Instructions describe all models and standard and optional equipment of your vehicle that were available at the time of going to print. Country-specific variations are possible. Note that your vehicle may not be equipped with all of the described functions. This also applies to systems and functions relevant to safety. The equipment in your vehicle may therefore differ from that shown in the descriptions and illustrations.

The original purchase contract documentation for your vehicle contains a list of all of the systems in your vehicle.

If you have questions about equipment and operation, consult any authorized Sprinter Dealer.

Service and vehicle operation

Warranty

The Limited Warranty for your vehicle is in accordance with the warranty terms in the Service and Warranty Information booklet.

Your authorized Sprinter dealer will replace and repair all factory-installed parts in accordance with the terms of the following warranties:

- New Vehicle Limited Warranty
- Exhaust System Warranty
- Emission Systems Warranty
- California, Connecticut, Maine, Massachusetts, New York, Pennsylvania, Rhode Island and Vermont Emission Control System Warranty
- State Warranty Enforcement Laws ("Lemon Laws")

Replacement parts and accessories are covered by the Mercedes-Benz Parts and Accessories Warranties. You can obtain these from any authorized Sprinter dealer.

i Should you lose your Service and Warranty Information booklet, contact an authorized Sprinter dealer for a replacement. The new Service and Warranty Information booklet will be posted to you.

Customer information for California

In California you are entitled to demand that your vehicle be exchanged or that the purchase or leasing price be refunded if Mercedes-Benz USA, LLC and/or authorized workshops or service centers are not able, after several justifiable repairs, to rectify major damage to or malfunctions of the vehicle as covered by the contractual warranty provisions. Customers who purchase or lease a vehicle can have the vehicle repaired within a period of 18 months after delivery or after a mileage of up to 29,000 km (equals approx. 18,000 miles), whichever comes first, if:

- (1) the same serious defect or damage which could lead to fatal or serious injuries to the occupants of the vehicle during driving has been repaired at least twice and Mercedes-Benz, LLC has been informed in writing of the necessity of such a repair.
- (2) the same defect or damage, although less serious than described in (1), has been

repaired at least four times and Mercedes-Benz has been informed of the necessity of such a repair in writing.

- (3) the vehicle cannot be operated for more than 30 calendar days due to repairs resulting from the same or other major defects or damage.

Please send written notification to:
Mercedes-Benz USA, LLC
Customer Assistance Center
One Mercedes Drive
Montreal, N 07645-0350

1-800-387-0100. This enables us, if necessary, to contact you at any time.

If you sell your Mercedes, please leave all the literature in the vehicle so that it is available for the next owner.

If your vehicle was purchased as a used vehicle, please send us the "Notice of Purchase of Used Car" from the Service and Warranty Information booklet or phone the Mercedes-Benz Customer Assistance Center (USA) on hotline number 1-800-FOR-MERcedes (1-800-367-6372) or Customer Service (Canada) on 1-800-387-0100.

Maintenance

The Service and Warranty Information booklet describes all the necessary maintenance work which should be performed at regular intervals. Always bring the Service and Warranty Information booklet with you when taking the vehicle to an authorized Sprinter dealer. Your customer service advisor enters each service into the Service and Warranty Information booklet for you.

Roadside Assistance

The Mercedes-Benz Roadside Assistance Program provides you with technical assistance in the case of a breakdown. Your toll-free calls to the Roadside Assistance Hotline are answered by our staff around the clock. 365 days a year.

1-800-FOR-MERcedes (1-800-367-6372)
(USA)

1-800-387-0100 (Canada)

Further information can be found in the Mercedes-Benz Roadside Assistance-Program brochure (USA) or the "Roadside Assistance" section of the Service and Warranty Information booklet (Canada). Both are located in your vehicle document wallet.

Change of address or owner

Please use the " Notice of Change of Address" form in the Service and Warranty Information booklet to inform us of a change of address, or simply phone the Mercedes-Benz Customer Assistance Center (USA) on hotline number 1-800-FOR-MERcedes (1-800-367-6372) or Customer Service (Canada) on

Operating the vehicle outside of the USA and Canada

When traveling abroad with your vehicle, observe the following points:

- Service facilities or replacement parts may not be available immediately.
- Unleaded fuel for vehicles with a catalytic converter may not be available. Leaded fuel can cause damage to the catalytic converter.
- The fuel may have a considerably lower octane rating. Unsuitable fuel can cause engine damage.

Certain Mercedes-Benz models are available in Europe through our European Delivery Program. Please consult an authorized Sprinter dealer for further information, or write to one of the following addresses:

In the USA

Mercedes-Benz USA, LLC
European Delivery Department
One Mercedes Drive
Montreal, N 07645-0350

In Canada

Mercedes-Benz Canada, Inc.
European Delivery Department
98 Vanderhoof Avenue
Toronto, Ontario M4G 4C9

Proper use

Observe the following information when operating your vehicle:

- the safety notes in these operating instructions
- the technical data in these Operating Instructions
- traffic laws and regulations
- motor vehicle laws and safety standards

There are various warning stickers affixed to the vehicle. If you remove warning stickers, you and others may fail to recognize the dangers. Leave the warning stickers in their original position.

WARNING

Modifications to electronic components, their software as well as wiring can impair their function and/or the function of other networked components. In particular, systems relevant to safety could also be affected. As a result, these may no longer function as intended and/or jeopardize the operating safety of the vehicle. There is an increased risk of an accident and injury.

Never tamper with the wiring as well as electronic components or their software. You should have all work to electrical and electronic equipment carried out at a qualified specialist workshop.

The general operating permit for your vehicle could be rendered invalid if you carry out modifications to electronic components, their software as well as wiring.

WARNING

Gases and fluids from substances that constitute a health hazard or react aggressively can escape even from securely closed containers. When transporting such substances in the vehicle interior, your ability to concentrate or your health could be affected during the journey. Malfunctions, short circuits or electrical component system failures may also result. There is a risk of an accident and fire.

Do not store or transport any substances in the vehicle interior which are hazardous to health or react aggressively.

These instructions must also be observed for vehicles where the cargo compartment is not fully separated from the driver's cab.

Partition with door/window: always keep the door/window in the partition closed during transport.

Examples of substances that are hazardous to health and/or react aggressively:

- Solvents
- Fuel
- Oil and grease
- Cleaning agents
- Acids

Protection of the environment

Economic and environmentally aware driving

Environmental note

Daimler's declared policy is one of comprehensive environmental protection.

The objectives are for the natural resources that form the basis of our existence on this planet to be used sparingly and in a manner that takes the requirements of both nature and humanity into account.

You too can help to protect the environment by operating your vehicle in an environmentally responsible manner.

Fuel consumption and the rate of engine, transmission, brake and tire wear are affected by these factors:

- operating conditions of your vehicle
- your personal driving style

You can influence both factors. You should bear the following in mind:

Operating conditions:

- avoid short trips as these increase fuel consumption.
- always make sure that the tire pressures are correct.
- do not carry any unnecessary weight.
- remove roof racks once you no longer need them.
- a regularly serviced vehicle will contribute to environmental protection. You should therefore adhere to the service intervals.
- always have service work carried out at a qualified specialist workshop.

Personal driving style:

- do not depress the accelerator pedal when starting the engine.
- do not warm up the engine when the vehicle is stationary.
- drive carefully and maintain a safe distance from the vehicle in front.
- avoid frequent, sudden acceleration and braking.
- change gear in good time and use each gear only up to $\frac{2}{3}$ of its maximum engine speed.
- switch off the engine in stationary traffic.
- keep an eye on the vehicle's fuel consumption.

Environmental issues and recommendations

When prompted by this Operator's Manual to dispose of materials, please try to regenerate and recycle these materials. Observe all relevant environmental guidelines and regulations when disposing of materials. This helps to protect the environment.

Operating safety and vehicle approval**Important safety notes** **WARNING**

If you do not have the prescribed service/maintenance work or any required repairs carried out, this can result in malfunctions or system failures. There is a risk of an accident. Always have the prescribed service/maintenance work as well as any required repairs carried out at a qualified specialist workshop.

Air bags and pyrotechnic Emergency Tensioning Devices (ETDs) contain perchlorate material, which may require special handling and regard for the environment. The guidelines must be observed during disposal.

In California, you can find more information on the Internet at www.dtsc.ca.gov.

Notes on operating the vehicle

There is a risk of damage to the vehicle if:

- the vehicle makes contact with the ground, e.g. on a high curb or a loose road surface
- you drive too quickly over an obstacle, e.g. a curb or a pothole
- a heavy object hits the underbody or chassis component

In these or similar situations, the vehicle body/frame, the underbody, chassis components, wheels or tires could be damaged even if this is not visible from the outside. Components that have been damaged in this way can unexpectedly fail or no longer be able to assimilate the loads occurring in the event of an accident. If the underbody paneling is damaged, flammable material, such as leaves, grass or twigs, could collect between the underbody and underbody paneling. These materials could ignite if they remain in contact with hot components of the exhaust system for an extended period.

 **WARNING**

Flammable material such as leaves, grass or twigs may ignite if they come into contact with hot parts of the exhaust system. There is a risk of fire.

When driving off road or on unpaved roads, check the vehicle's underside regularly. In particular, remove parts of plants or other flammable materials which have become trapped. In the case of damage, contact a qualified specialist workshop.

Have the vehicle checked and repaired immediately at a qualified specialist workshop. If you become aware when continuing the journey that driving safety has been effected, stop as soon as possible in accordance with the traffic conditions. In such cases, consult a qualified specialist workshop.

Declaration of conformity

Radio-based vehicle components

USA: "The wireless devices of this vehicle comply with Part 15 of the FCC Rules. Operation is subject to the following two conditions: 1) These devices may not cause harmful interference. 2. This device must accept any interference received, including interference that may cause undesired operation. Changes or modifications not expressly approved by the party responsible for compliance could void the user's authority to operate the equipment."

Canada: "The wireless devices of this vehicle comply with Industry Canada license-exempt RSS standard(s). Operation is subject to the following two conditions: 1) These devices may not cause interference, and 2) these devices must accept any interference received, including interference that may cause undesired operation of the device".

Diagnostics connection

The diagnostics connection is only intended for the connection of diagnostic equipment at a qualified specialist workshop.

WARNING

If you connect equipment to the diagnostics connection in the vehicle, it may affect the operation of the vehicle systems. As a result, the operating safety of the vehicle could be affected. There is a risk of an accident.

Do not connect any equipment to a diagnostics connection in the vehicle.

Changing the engine power output

! Increases in engine power can:

- change the emission values
- cause malfunctions
- cause consequential damage

The operating reliability of the engine is not guaranteed in all cases.

Any tampering with the engine management system in order to increase the engine power output will lead to the loss of the New Vehicle Limited Warranty and other warranty entitlements.

If you sell the vehicle, inform the purchaser about the changes to the engine power output of the vehicle. If you do not inform the buyer, this may constitute a punishable offense under national legislation.

Qualified specialist workshops

An authorized Sprinter Dealer is a qualified specialist workshop.

A qualified specialist workshop has the necessary specialist knowledge, tools and qualifications to correctly carry out the work required on the vehicle.

This is especially the case for work relevant to safety. Observe the notes in the Maintenance or Service Booklet.

The following work should always be carried out at qualified specialist workshop:

- work relevant to safety
- service and maintenance work
- repair work
- modifications as well as installations and alterations
- work on electronic components

For this reason, we recommend an authorized Sprinter Dealer.

! Only have work carried out on the engine electronics and its associated parts, such as control units, sensors, actuating components and connector leads, at a qualified specialist workshop. Vehicle components may other-

wise wear more quickly and the vehicle's operating permit may be invalidated.

Problems with your vehicle

If you experience problems with your vehicle, particularly problems which could jeopardize vehicle safety, consult an authorized Sprinter dealer to have the problems diagnosed and rectified. If the problem is not resolved to your satisfaction, consult an authorized Sprinter dealer again or write to one of the following addresses.

In the USA

Customer Assistance Center
Mercedes-Benz USA, LLC
One Mercedes Drive
Montreal, N 07645-0350

In Canada

Customer Relations Department
Mercedes-Benz Canada, Inc.
98 Vanderhoof Avenue
Toronto, Ontario M4G 4C9

Reporting malfunctions relevant to safety

USA only:

The following text is published as required of all manufacturers under Title 49, Code of U.S. Federal Regulations, Part 575 pursuant to the "National Traffic and Motor Vehicle Safety Act of 1966".

If you believe that your vehicle has a defect which could cause a crash or could cause injury or death, you should immediately inform the National Highway Traffic Safety Administration (NHTSA) in addition to notifying Mercedes-Benz USA, LL.

If NHTSA receives similar complaints, it may open an investigation, and if it finds that a safety defect exists in a group of vehicles, it may order a recall and remedy campaign. However, NHTSA cannot become involved in individual problems between you, your dealer, or Mercedes-Benz USA, LL.

To contact NHTSA, you may call the Vehicle Safety Hotline toll-free at 1-888-327-4236 (TTY: 1-800-424-9153); go to <http://www.safercar.gov>; or write to: Administrator,

www.safercar.gov; or write to: Administrator,

NHTSA, 400 Seventh Street, SW., Washington, DC 20590.

You can find more information on vehicle safety at:

<http://www.safercar.gov>

Registering your vehicle

Mercedes-Benz may ask its authorized Sprinter dealers to carry out technical inspections on certain vehicles. This is always the case if the quality or safety of the vehicle is improved as a result of the inspection. Mercedes-Benz can only inform you about vehicle checks if it has your registration data.

Your registration data is not stored if:

- you did not purchase your vehicle at an authorized Sprinter Dealer
- your vehicle has never been inspected at an authorized Sprinter Dealer

It is advisable to register your vehicle with an authorized Sprinter Dealer. Inform an authorized Sprinter dealer as soon as possible about any change of address or vehicle ownership.

Attachments, bodies, equipment and conversions

Information about body/equipment mounting directives

! For safety reasons, have add-on equipment manufactured and installed according to the Sprinter body/equipment mounting directives in force. These body/equipment mounting directives ensure that the chassis and the body form one unit and that maximum operating and road safety is achieved.

We recommend for safety reasons that:

- you carry out no other modifications to the vehicle.
- you obtain the agreement of the distributor named on the inside of the front cover for any deviations from the approved body/equipment mounting directives.

Approval from certified inspection agencies or official approvals cannot rule out risks to your safety.

Please observe the information concerning Mercedes-Benz Genuine Parts (> page 28).

Further information can be obtained at any authorized Sprinter Dealer.

WARNING

The function of systems or components can be affected by conversions or modifications to the vehicle. They might not function properly anymore and/or jeopardize the operational safety of the vehicle. There is an increased risk of an accident and injury.

Conversions or modifications should always be carried out at qualified specialist workshop.

If you intend to make modifications to your vehicle, we strongly recommend that you contact the distributor named on the inside of the front cover. There you will receive all the necessary information and a charge may be levied.

You alone accept the responsibility if body manufacturers or dealers make modifications that affect the final certification of the engine, the vehicle or the equipment. This also applies to the identification and documentation of modifications to the affected vehicle components.

You are responsible for certification and confirmation that:

- all the applicable standards and regulations that are affected by the vehicle modification are met
- the modified vehicle fulfills the vehicle safety standards and emissions laws and regulations
- the modifications or installation of accessories does not affect the safety of the vehicle

We are not responsible for the final certification, product liability or warranty claims which result from the modifications. This applies to:

- the modified components, assemblies or systems
- any resulting noncompliance with any of the emissions laws and regulations or the motor vehicle safety standards
- any consequences arising from the changes that make the vehicle less safe or even render it defective

We do not assume responsibility as the final-stage manufacturer or for the consequential product liability.

Notes on the radiator

Even seemingly small changes to the vehicle, such as attaching a radiator trim for winter driving, is not permitted. Do not cover up the radiator. Do not use thermal mats, insect protection covers or anything similar.

Otherwise, the values of the diagnostic system may be affected. Some of these values are legally prescribed and must always be correct.

Information on the cargo compartment floor

 The wooden or plastic cargo area floor fitted at the factory is an integral component of the vehicle structure. The vehicle body could be damaged if you have the load area floor removed. This then affects the securing of loads and the maximum loading capacity of the lashing points is no longer guaranteed. Therefore, do not have the load area floor removed.

Genuine Mercedes-Benz parts

 Air bags and Emergency Tensioning Devices, as well as control units and sensors for these restraint systems, may be installed in the following areas of your vehicle:

- doors
- door pillars
- door sills
- seats
- cockpit
- instrument cluster
- center console

Do not install accessories such as audio systems in these areas. Do not carry out repairs or welding. You could impair the operating efficiency of the restraint systems.

Have aftermarket accessories installed at a qualified specialist workshop.

Environmental note

We supply reconditioned assemblies and parts which are of the same quality as new parts. The same New Vehicle Limited Warranty applies as for new parts.

The operating safety of the vehicle could be jeopardized if you use parts, tires and wheels as well as accessories relevant to safety which have not been approved by Mercedes-Benz. This could lead to malfunctions in safety-relevant systems, e.g. the brake system. Only use genuine Mercedes-Benz parts or parts of equal quality. Only use tires, wheels and accessories that have been specifically approved for your vehicle.

We test genuine Sprinter parts, as well as conversion parts and accessories that have been specifically approved for the type of vehicle, for:

- reliability
- safety
- suitability

Despite ongoing market research, Mercedes-Benz is unable to assess other parts. Therefore, we accept no responsibility for the use of such parts in Sprinter vehicles, even if they have been officially approved or independently approved by a testing center.

In some countries, certain parts are only officially approved for installation or modification if they comply with legal requirements. All genuine Sprinter parts satisfy these requirements. Make sure that all parts are suitable for your vehicle.

Always specify the vehicle identification number (VIN) and engine number when ordering genuine Sprinter parts (▷ page 276).

QR code for rescue card

The QR Code stickers are affixed to the B-pillar on the driver's and front-passenger side.

In the event of an accident the rescue services use the QR Code to quickly find the rescue card for your vehicle. The current rescue card contains the most important information on your vehicle, e.g. the electric cable routes, in a compact form.

Further information can be found under <http://portal.aftersales.i.daimler.com>.

Data stored in the vehicle

Data Recording

A wide range of electronic components in your vehicle contain data memories.

These data memories temporarily or permanently store technical information about:

- the vehicle's operating state
- events
- faults

In general, this technical information documents the state of a component, a module, a system or the surroundings.

These include, for example:

- operating conditions of system components, e.g. fluid levels
- the vehicle's status messages and those of its individual components, e.g. number of wheel revolutions/speed, deceleration in movement, lateral acceleration, accelerator pedal position
- malfunctions and defects in important system components, e.g. lights, brakes
- vehicle reactions and operating conditions in special driving situations, e.g. airbag deployment, intervention of stability control systems
- ambient conditions, e.g. outside temperature

This data is of an exclusively technical nature and can be used to:

- assist in detecting and rectifying faults and defects
- analyze vehicle functions, e.g. after an accident
- optimize vehicle functions

The data cannot be used to trace the vehicle's movements.

When your vehicle is serviced, technical information can be read from the event data memory and fault data memory.

Services include, for example:

- repair services
- service processes
- warranty events
- quality assurance

The vehicle is read out by employees of the service network (including the manufacturer) using special diagnostic testers. You can obtain more information there, if required.

After a fault has been rectified, the information is deleted from the fault memory or is continually overwritten.

When operating the vehicle, situations are conceivable in which this technical data, in connec-

tion with other information (if necessary, after consultation with an authorized expert), could be traced to a person.

Examples include:

- accident reports
- damage to the vehicle
- witness statements

Further additional functions that have been contractually agreed upon with the customer allow certain vehicle data to be conveyed by the vehicle as well. The additional functions include, for example, vehicle location in case of an emergency.

COMAND/mbrace (Canada: TELEAID)

If the vehicle is equipped with COMAND or mbrace, additional data about the vehicle's operation, the use of the vehicle in certain situations, and the location of the vehicle may be compiled through COMAND or the mbrace system.

For additional information please refer to the COMAND User Manual and/or the mbrace Terms and Conditions.

Event Data Recorders

This vehicle is equipped with an event data recorder (EDR). The main purpose of an EDR is to record, in certain crash or near crash-like situations, such as an air bag deployment or hitting a road obstacle, data that will assist in understanding how a vehicle's systems performed. The EDR is designed to record data related to vehicle dynamics and safety systems for a short period of time, typically 30 seconds or less. The EDR in this vehicle is designed to record such data as:

- How various systems in your vehicle were operating;
- Whether or not the driver and passenger safety belts were buckled/fastened;
- How far (if at all) the driver was depressing the accelerator and/or brake pedal; and,
- How fast the vehicle was traveling.

These data can help provide a better understanding of the circumstances in which crashes and injuries occur. NOTE: EDR data are recorded by your vehicle only if a non-trivial crash situa-

tion occurs; no data are recorded by the EDR under normal driving conditions and no personal data (e.g., name, gender, age, and crash location) are recorded. However, other parties, such as law enforcement could combine the EDR data with the type of personally identifying data routinely acquired during a crash investigation.

Access to the vehicle and/or the EDR is needed to read data that is recorded by an EDR, and special equipment is required. In addition to the vehicle manufacturer, other parties that have the special equipment, such as law enforcement, can read the information by accessing the vehicle or the EDR.

EDR data may be used in civil and criminal matters as a tool in accident reconstruction, accident claims, and vehicle safety. Since the Crash Data Retrieval CDR tool that is used to extract data from the EDR is commercially available, Mercedes-Benz USA, LLC ("MBUSA") expressly disclaims any and all liability arising from the extraction of this information by unauthorized Mercedes-Benz personnel.

MBUSA will not share EDR data with others without the consent of the vehicle owners or, if the vehicle is leased, without the consent of the lessee. Exceptions to this representation include responses to subpoenas by law enforcement; by federal, state or local government; in connection with or arising out of litigation involving MBUSA or its subsidiaries and affiliates; or, as required by law.

Warning: The EDR is a component of the Restraint System Module. Tampering with, altering, modifying or removing the EDR component may result in a malfunction of the Restraint System Module and other systems.

State laws or regulations regarding EDRs that conflict with federal regulation are pre-empted. This means that in the event of such conflict, the federal regulation governs. As of February 2013, 13 states have enacted laws relating to EDRs.

Cockpit

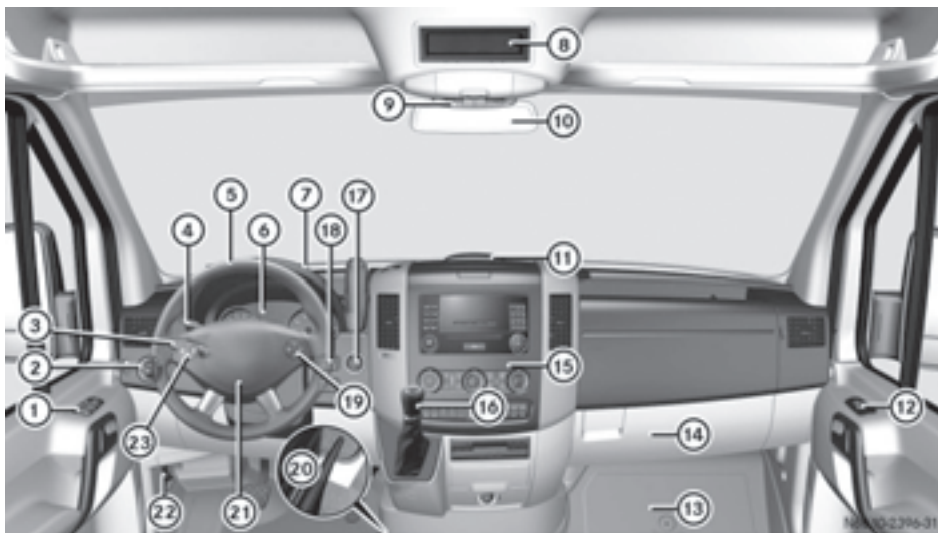

	Function	Page		Function	Page	
①	Door control panel	37	⑪	PARKTRONIC warning display	151	
②	Light switch	79	⑫	Opens/closes the right-hand side window	71	
③	Combination switch	• turn signals	81	⑬	Stowage compartment (jack and vehicle tool kit)	240
		• high-beam headlamps	81			
		• windshield wipers	93			
		• rear window wiper	94			
④	Cruise control lever	140	⑭	Glove box	204	
⑤	Steering wheel without or with buttons	35	⑮	Center console	35	
⑥	Instrument cluster	32	⑯	Selector lever (automatic transmission)	124	
⑦	Stowage compartment	• 3.5 mm audio jack	211	⑰	Ignition lock	119
		• USB port	211	⑱	Further control panels	37
⑧	Timer for the auxiliary warm-air heater (auxiliary heating)	114	⑲	Steering wheel buttons	35	
⑨	• Stowage compartment with interior light	84	⑳	Engages/releases the parking brake	136	
		• Overhead control panel			36	
⑩	Rear-view mirror	78	㉑	Horn		
				㉒	Opens the hood	218
			㉓	Steering wheel buttons	35	

Instrument cluster

Displays and controls

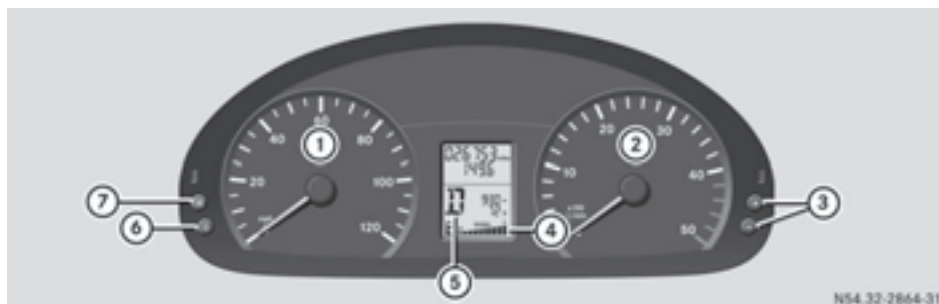

NS4-32-2864-31

Instrument cluster on vehicles without steering wheel buttons



NS4-32-2865-31

Instrument cluster in vehicles with steering-wheel buttons

	Function	Page
①	Speedometer	162
②	Tachometer	162
③	⊕, ⊖ Brightens/dims the instrument cluster lighting	162
④	Fuel gage with fuel filler flap location indicator	162
⑤	Display	
	Vehicles without steering wheel buttons	163
	Vehicles with steering wheel buttons	164

	Function	Page
⑥	Reset button (⓪)	32
⑦	Menu button (Ⓜ)	
	• changes standard display	163
	• selects menus	164
⑧	Service button (Ⓛ)	
	Checks the engine oil level	220

Indicator and warning lamps



NS4_32-3024-31

















At a glance

















Instrument cluster on vehicles without steering wheel buttons





















NS4_32-3025-31

Instrument cluster in vehicles with steering-wheel buttons

	Function	Page		Function	Page
①	Speedometer with warning and indicator lamps			Brake fluid level too low	195
	ESP® warning lamp ASR warning lamp	194 194		EBD malfunctioning	195
	Coolant level too low	199		Trailer brake force booster malfunction	195
	Coolant temperature too high	199		Engine oil level warning	198
	Restraint systems malfunction	39		Check Engine indicator lamp	200
	Indicator lamp, distance warning	143		Preglow	120
	Warning lamp, distance warning	143		Preglow system malfunction	201
	Warning and indicator lamps, Lane Keeping Assist	147	②	Indicator and warning lamps	
				Left-hand turn signal	81
				ABS malfunction	195
				Tire pressure loss or the tire pressure monitor is malfunctioning (USA only)	202
				Tire pressure loss (Canada only)	255

	Function	Page
	Fluid level too low in windshield washer/headlamp cleaning system	202
	DEF supply low or contaminated/diluted	162
	Exhaust gas aftertreatment malfunction	197
	Indicator lamp, distance warning	143
	Warning lamp, distance warning	143
	Warning and indicator lamps, Lane Keeping Assist	147
	Door or hood open	203
	Electrically operated step malfunction	203
	Brake pads/linings worn	198
	LOW RANGE active	148
	High-beam headlamps on (vehicle with steering wheel buttons)	81
	Right-hand turn signal	81
	ASR malfunction BAS malfunction	53 195
	ESP [®] malfunction	194
	Dirt accumulation in air filter	201
	Reserve fuel	162
	Fuel filler cap open	200

	Function	Page
	Water in the fuel	202
	Fuel filter dirty	202
	Battery charging malfunction	198
	Bulb defective	203
	Tachometer with warning and indicator lamps	
	Parking brake applied	136
	Low-beam headlamps on	79
	Working speed governor (ADR) on	154
	Power steering assistance malfunction	203
	High-beam headlamps on (vehicle without steering wheel buttons)	81
	DEF supply low or contaminated/diluted	162
	Exhaust gas aftertreatment malfunction	197
	Reserve fuel	200
	Fuel filler cap open	200
	Diesel particle filter malfunction	201
	ESP [®] malfunction	194
	Fasten seat belts	203

 Corresponding messages may also be shown in the display (> page 176).

Steering wheel buttons







	Function	Page
①	Display	164
	On-board computer operation	
②	Selects a submenu or adjusts the volume Up/increases the volume Down/reduces the volume Using the telephone Accepts a call/starts dialing Ends a call/rejects an incoming call	164 175
③	Scrolls from one menu to another Forwards Back Scrolls within a menu Forwards Back	164 164

Center console



	Function	Page
①	Stowage compartment	205
②	Audio 10 or Audio 15 (see the separate operating instructions)	
③	Air-conditioning control panel Paper holder ¹	97 207
④	Center console control panel	
	Switches the left/right-hand seat heating on/off	76
	Switches the windshield heating on/off	104
	Switches the rear window defroster on/off	104
	Activates/deactivates PARKTRONIC	153
	Switches the hazard warning lamps on/off	82

¹ Only on vehicles without rear-compartment climate control.

	Function	Page
	Activates/deactivates ASR	53
	Central locking, interior/rear compartment	64
	Activates/deactivates the distance warning function	143
	Activates/deactivates Lane Keeping Assist	147
	Activates/deactivates Blind Spot Assist	144
⑤	<ul style="list-style-type: none"> • Stowage compartment or CD changer; see the separate operating instructions, or 	
⑥	Cup holder with: <ul style="list-style-type: none"> • Ashtray • Cigarette lighter 	208 209 209
⑦	12 V socket	210

Overhead control panel

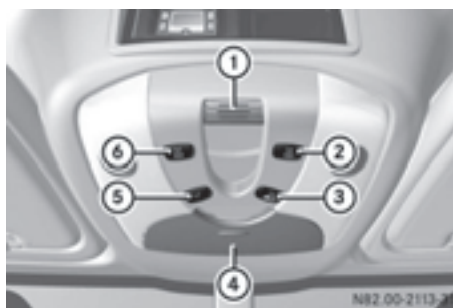

	Function	Page
①	Microphone for the mobile phone	210
②	Switches the right-hand reading lamp on/off	84
③	Switches the automatic interior lighting on/off	84
④	<ul style="list-style-type: none"> • Eyeglasses compartment or • Anti-Theft Alarm system (ATA) 	205 56
⑤	Switches the interior lighting on/off	84
⑥	Switches the left-hand reading lamp on/off	84

Door control panel



	Function	Page
①	Adjusts the exterior mirrors	78
②	Selects an exterior mirror	78
③	Opens/closes the left-hand side window	71
④	Opens/closes the right-hand side window	71

Further control panels



Control panel between the light switch and the steering wheel



	Function	Page
	Switches the auxiliary heating on/off	108
	Switches the heater booster function on/off	111
	Sets the working speed	154
	Switches the working speed governor (ADR) on/off	154
	Ventilates the cargo compartment	117

Control panel between the steering wheel and the ignition lock



	Function	Page
	Switches the central rear compartment lighting on/off	84
	Engages/disengages all-wheel drive	148
	Activates/deactivates LOW RANGE transmission ratio	148

Useful information

This Operator's Manual describes all models as well as standard and optional equipment of your vehicle that were available at the time of going to print. Country-specific variations are possible. Note that your vehicle may not be equipped with all of the described functions. This also applies to systems and functions relevant to safety.

Read the information on qualified specialist workshops (▷ page 26).

Occupant safety

Restraint system introduction

The restraint system can reduce the risk of vehicle occupants coming into contact with parts of the vehicle's interior in the event of an accident. Furthermore, the restraint system may also reduce the forces exerted on the vehicle occupants when an accident occurs.

The restraint system includes:

- Seat belt system
- Air bags
- Child restraint system
- Child seat securing systems

The components of the restraint system work in conjunction with each other. They can only offer the intended level of protection if all vehicle occupants:

- are correctly wearing their seat belts. (▷ page 41)
- adjust their seat and head restraint properly (▷ page 72).

The driver is also responsible for ensuring that the steering wheel has been correctly positioned. Observe the information relating to the correct driver's seat position (▷ page 72).

Always ensure the air bag can inflate properly if deployed (▷ page 43).

An air bag supplements a correctly fastened seat belt. As an additional safety device, the air bag increases the level of protection for vehicle occupants in the event of an accident. For example, if the protection already provided by a correctly fastened seat belt will suffice, the air bags are not deployed. Furthermore, only the air bags that would increase the degree of protection afforded to the vehicle occupants in the event of

an accident are deployed. Seat belts and air bags generally do not protect against objects penetrating the vehicle from the outside.

Information on restraint system operation can be found under "Triggering of Emergency Tensioning Devices and air bags" (▷ page 45).

See "Children in the vehicle" for information on children traveling with you as well as vehicle restraint systems (▷ page 47).

Important safety notes

WARNING

Modifications to the restraint system, may cause it to no longer work as intended. The restraint system may then not perform its intended protective function and may fail in an accident or trigger unexpectedly, for example. This poses an increased risk of injury or even fatal injury.

Never modify parts of the restraint system. Never tamper with the wiring, the electronic components or their software.

If it is necessary to modify an airbag system to accommodate a person with disabilities, contact an authorized Sprinter dealership for details. USA only: contact our Customer Assistance Center at 1-877-762-8267 for details.

Restraint system warning lamp

The functions of the restraint system are checked after the ignition is switched on and at regular intervals while the engine is running. Therefore, malfunctions can be detected in good time.

The  restraint system warning lamp in the instrument cluster lights up when the ignition is switched on. It goes out no later than a few seconds after the vehicle is started. The components of the restraint system are in operational readiness.

A malfunction has occurred if the  restraint system warning lamp:

- does not light up after the ignition is switched on
- does not go out after a few seconds
- goes out but then lights up again while the engine is running, for example

WARNING

If restraint system is malfunctioning, restraint system components may be triggered unintentionally or might not be triggered at all in the event of an accident with a high rate of vehicle deceleration. This can affect the Emergency Tensioning Device or air bag, for example. This poses an increased risk of injury or even fatal injury.

Have the restraint system checked and repaired in a qualified specialist workshop as soon as possible.

Seat belts

Introduction

A correctly fastened seat belt is the most effective means of restraining the movement of vehicle occupants in the event of an accident or the vehicle rolling over. This reduces the risk of vehicle occupants coming into contact with parts of the vehicle interior or being thrown from the vehicle. Furthermore, the seat belt helps to keep the vehicle occupants in the best position in relation to the air bag.

The seat belt system consists of:

- Seat belts
- Emergency Tensioning Devices for the front seat belts

If the vehicle is equipped with a front air bag, the seat belt system also includes a seat belt force limiter for the corresponding seat.

On vehicles with a front-passenger bench seat, only the seat belt of the outer front-passenger seat has a seat belt force limiter.

If the vehicle does not have a driver's air bag, the seat belt system does not include an Emergency Tensioning Device or a seat belt force limiter.

If the seat belt is pulled quickly or suddenly from the belt outlet, the inertia reel locks. The belt strap cannot be pulled out further.

Emergency Tensioning Devices tighten the seat belts in an accident, pulling them close against the occupant's body. They do not, however, pull vehicle occupants back towards the backrest.

Emergency Tensioning Devices do not correct an incorrect seat position or incorrectly worn seat belts.

When triggered, the seat belt force limiter reduces the force exerted by the seat belt on the vehicle occupant.

The seat belt force limiters are synchronized with the front air bags, which absorb part of the deceleration force. This makes it possible to reduce the forces to which vehicle occupants are subjected during an accident.

The Emergency Tensioning Device of the co-driver's seat is triggered independently of the lock status of the seat belt.

Important safety notes

The use of seat belts and child restraint systems is required by law in:

- all 50 states
- the U.S. territories
- the District of Columbia
- all Canadian provinces

Even where this is not required by law, all vehicle occupants should correctly fasten their seat belts before starting the journey.

WARNING

If the seat belt is incorrectly fastened, it cannot protect as intended. Furthermore, an incorrectly fastened seat belt can cause additional injury, for example, in an accident, during braking or when abruptly changing direction. This poses an increased risk of injury or even fatal injury.

Make sure that all vehicle occupants are seated properly with a correctly fastened seat belt.

WARNING

The seat belt does not offer the intended level of protection if you have not moved the backrest to an almost vertical position. When braking or in the event of an accident, you could slide underneath the seat belt and sustain abdomen or neck injuries, for example. This

poses an increased risk of injury or even fatal injury.

Adjust the seat properly before beginning your journey. Always ensure that the backrest is in an almost vertical position and that the shoulder section of your seat belt is routed across the center of your shoulder.

WARNING

Persons under 5 ft (1.50 m) in height cannot fasten the seat belt correctly without an additional suitable restraint system. If the seat belt is incorrectly fastened, it cannot protect as intended. Furthermore, an incorrectly fastened seat belt can cause additional injury, for example, in an accident, during braking or an abrupt change of direction. This poses an increased risk of injury or even fatal injury.

For this reason, always secure persons under 5 ft (1.50 m) in height in suitable restraint systems.

If a child younger than twelve years old and under 5 ft (1.50 m) in height is traveling in the vehicle:

- always secure the child in a child restraint system suitable for this vehicle. The child restraint system must be appropriate to the age, weight and size of the child
- always observe the instructions and safety notes in the "Children in the vehicle" section of this Operator's Manual (▷ page 47) in addition to the child restraint system manufacturer's installation instructions

WARNING

The seat belts may not perform their intended protective function if:

- they are damaged, modified, extremely dirty, bleach or dyed
- the seat belt buckle is damaged or extremely dirty
- the Emergency Tensioning Devices, belt anchorages or inertia reels have been modified

Seat belts may sustain non-visible damage in an accident, e.g. due to glass splinters. Modi-

fied or damaged seat belts may tear or fail, e.g. in an accident. Modified Emergency Tensioning Devices could accidentally trigger or fail to deploy when necessary. This poses an increased risk of injury or even fatal injury.

Never modify the seat belts, Emergency Tensioning Devices, belt anchorages or inertia reels. Make sure that the seat belts are undamaged, not worn out and clean. Following an accident, have the seat belts checked immediately at a qualified specialist workshop.

Only use seat belts that have been approved for your vehicle by the sales organization named on the inside cover.

Proper use of the seat belts

Pay attention to the safety notes about the seat belt (▷ page 40).

All vehicle occupants must fasten the seat belt correctly before setting off. Make sure that all occupants are wearing their seat belts correctly for the entire journey.

When fastening the seat belt, make sure that:

- The seat belt tongue is inserted into the belt buckle that belongs to the seat.
- The seat belt is tightened across your body. Avoid wearing bulky clothing, e.g. a winter coat.
- The seat belt is not twisted. Only then can the forces produced in the event of an accident be evenly distributed across the belt.
- The shoulder section of the belt must always be routed across the center of the shoulder. The shoulder section of the belt should not come into contact with your neck and must not be routed under the arm. Where possible, adjust the seat belt to the appropriate height.
- The lap belt must be taut and as low as possible over your lap.

The lap belt must always pass across your hip joints and never across your stomach or abdomen. Pregnant women must take particular care. If necessary, the lap belt can be pushed down across the hip joints and pulled tight using the shoulder section.

- The seat belt is not routed over sharp, pointed or fragile objects.

If these items are on or in your clothing, e.g. eyeglasses, pens, keys, etc., stow these items in a more suitable location.

- Only one person should use each seat belt at any one time.

On no account should babies or children travel sitting on the lap of another vehicle occupant. During an accident, they could be crushed between the occupant and seat belt.

- Objects are not secured with a seat belt if the seat belt is being used by one of the vehicle's occupants.

Also make sure that there are no objects, e.g. cushions, between the occupant and the seat.

Seat belts are solely intended for the protection and restraint of the vehicle occupants. To secure objects, luggage or loads, always observe the "Loading guidelines" (> page 212).

Fastening and adjusting seat belts

Observe the safety notes on the seat belt (> page 40) and the notes on correct use of seat belts (> page 41).



Basic illustration

- ▶ Adjust the seat (> page 72). The seat backrest must be in an almost vertical position.
- ▶ Pull the seat belt smoothly from belt outlet (3) and engage belt tongue (2) into belt buckle (1).
- ▶ If necessary, pull upwards on the shoulder section of the seat belt to tighten the belt across your body.

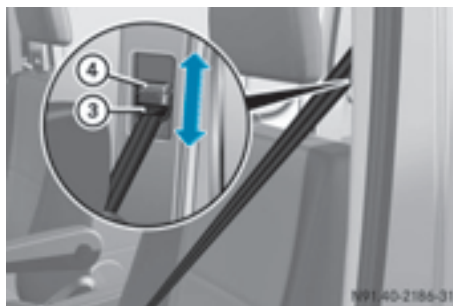

The shoulder section of the seat belt must always be routed across the center of the shoulder. Adjust the belt outlet if necessary.

- ▶ **To raise:** slide belt outlet (3) upwards. The belt outlet will engage in various positions.
- ▶ **To lower:** hold belt outlet release (4) and slide the belt outlet (3) downwards.
- ▶ Let go of belt outlet release (4) in the desired position and make sure that the belt outlet engages.

All seat belts except the driver's seat belt are equipped with a special seat belt retractor to securely fasten child restraint systems in the vehicle. Further information can be found under "Special seat belt retractor" (> page 48).

Releasing seat belts

- Make sure that the seat belt is fully rolled up. Otherwise, the seat belt or belt tongue will be trapped in the door or in the seat mechanism. This could damage the door, the door trim panel and the seat belt. Damaged seat belts can no longer fulfill their protective function and must be replaced. Visit a qualified specialist workshop.



Basic illustration

- ▶ Press release button ①, hold belt tongue ② firmly and guide it back towards belt outlet ③.

Belt warning for drivers and front passengers

The  seat belt warning lamp in the instrument cluster is a reminder that all vehicle occupants must wear their seat belts. It may light up continuously or flash. In addition, there may be a warning tone.

Regardless of whether the driver's seat belt has already been fastened, the  seat belt warning lamp lights up for 6 seconds after each time the ignition is switched on. After the engine has been started, it goes out once the driver has fastened the seat belt.

If the driver's seat belt is not fastened after the engine is started, an additional warning tone will sound. This warning tone stops after a maximum of six seconds or once the driver's seat belt is fastened.

If the vehicle speed exceeds 15 mph (25 km/h) and the driver's seat belt is not fastened, a warning tone sounds again. The warning tone sounds for 60 seconds or until the driver's seat belt is fastened.

If the driver unfastens the seat belt while the vehicle is in motion, the belt warning automatically reactivates.

- ❗ Further information on the  seat belt warning lamp; see "Warning and indicator

lamps in the instrument cluster"
(▷ page 203).

Air bags

Introduction

The air bag installation location is identified by the label SRS/AIR BAG or AIR BAG.

An air bag supplements a correctly fastened seat belt. However, it is not intended as a substitute for the seat belt. Air bags provide additional protection in the event of an accident.

Not all air bags are deployed in an accident. The various air bag systems work independently of each other (▷ page 45).

There is, however, no system available today that can completely rule out injury or death.

It is also not possible to rule out a risk of injury caused by an air bag due to the high speed at which the air bag must be deployed.

Important safety notes

WARNING

If you do not sit in the correct seat position, the air bag cannot protect as intended and could even cause additional injury when deployed. This poses an increased risk of injury or even fatal injury.

To avoid hazardous situations, always make sure that all of the vehicle's occupants:

- have fastened their seat belts correctly, including pregnant women
- are sitting correctly and maintain the greatest possible distance to the air bags
- follow the following instructions

Always make sure that there are no objects between the air bag and the vehicle's occupants.

- Correctly adjust the seats before driving off. Always make sure the seat backrests are positioned as close to the vertical as possible. The center of the head restraints should support the back of the head at about eye level.
- Move the driver's and front-passenger seat as far back as possible. The driver's seat position

must be such that the vehicle can be driven safely.

- Keep hands on the outside of the steering wheel rim. This allows the air bag to deploy fully.
- Always sit with your back against the seat backrest when driving. Do not lean forward, on the door or against the side window. Otherwise, you are in the air bag deployment area.
- Always keep your feet in the footwell in front of the seat. Do not, for example, place your feet on the dashboard. Otherwise, your feet are in the air bag deployment area.
- Suitable restraint systems must always be used for persons under 5 ft (1.50 m) in height. The seat belt cannot be worn correctly by persons who do not reach this height.

If children are also traveling in the vehicle, please take note of the following points.

- Always secure children younger than twelve years of age and under 5 ft (1.50 m) tall in suitable child restraint systems.
- Child restraint systems should preferably be installed on the rear seats.
- If you secure a child in a rearward-facing child restraint system, always do so on a suitable rear seat. The front-passenger front air bag cannot be deactivated.
- Be sure to observe the instructions and safety notes on "Children in the vehicle" (> page 47) and "Child restraint system on the front-passenger seat" (> page 51) in addition to the child restraint system manufacturer's installation instructions.

Objects in the passenger compartment could prevent an air bag from functioning properly. To prevent risks due to the required air bag speed after deployment, ensure the following before starting the journey:

- there are no persons, animals or objects between the vehicle occupants and an air bag.
- there are no objects between the seat, door and B-pillar.
- no hard objects, e.g. coat hangers, hang on the grab handles or coat hooks.
- no accessories, such as cup holders, are attached to the vehicle within the deployment

area of an air bag, e.g. to doors or side windows.

- there are no heavy, sharp or fragile objects in the pockets of items of clothing. Such items should be suitably stowed elsewhere.

WARNING

If you modify the air bag cover or affix objects such as stickers to it, the air bag can no longer function correctly. There is an increased risk of injury.

Never modify an air bag cover or affix objects to it.

WARNING

Sensors to control the air bags are located in the doors. Modifications or work not performed correctly to the doors or door paneling, as well as damaged doors, can lead to the function of the sensors being impaired. The air bags might therefore not function properly anymore. Consequently, the air bags cannot protect vehicle occupants as they are designed to do. There is an increased risk of injury.

Never modify the doors or parts of the doors. Always have work on the doors or door paneling carried out at a qualified specialist workshop.

Front air bags

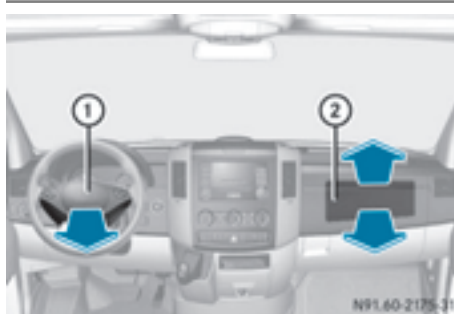

Driver's air bag ① deploys in front of the steering wheel. Front-passenger air bag ② deploys in front of and above the glove box and the center console.

When deployed, the front air bags offer additional head and thorax protection on the front seats.

Side impact air bags

Depending on the vehicle's equipment, some front seats are equipped with a side impact air bag; see the AIR BAG label on the outer side of the seat backrest.

WARNING

Unsuitable seat covers may obstruct or even prevent deployment of the air bags integrated into the seats. The air bags may then fail to protect the vehicle occupants as intended. There is an increased risk of injury, possibly even fatal.

Only use seat cushions that are approved for your vehicle by the distributor named on the inside cover page.



Side impact air bags ① deploy next to the outer bolster of the seat backrest.

When deployed, the side impact air bag offers additional thorax protection. However, it does not protect the:

- head
- neck
- arms

In the event of a side impact, the side impact air bag is deployed on the side on which the impact occurs.

Window curtain air bags

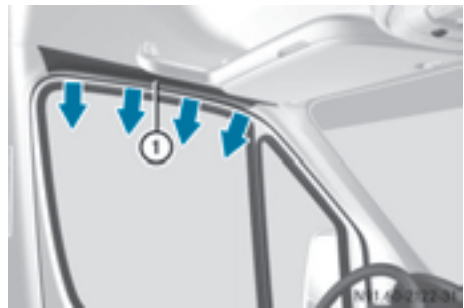

Window curtain air bags ① are installed in the side of the roof frame above the front doors.

When deployed, the window curtain air bag offers additional head protection. However, it does not protect the chest or arms.

In the event of a side impact, the window curtain air bag is deployed on the side on which the impact occurs.

If the system determines that it can offer additional protection to that provided by the seat belt, a window curtain air bag may be deployed in other accident situations (▷ page 45).

Deployment of Emergency Tensioning Devices and air bags

Important safety notes

WARNING

The air bag parts are hot after an air bag has been deployed. There is a risk of injury.

Do not touch the air bag parts. Have a deployed air bag replaced at a qualified specialist workshop as soon as possible.

WARNING

A deployed air bag no longer offers any protection and cannot provide the intended protection in an accident. There is an increased risk of injury.

Have the vehicle towed to a qualified specialist workshop in order to have a deployed air bag replaced.

It is important for your safety and that of any passengers to have deployed air bags replaced

and to have any malfunctioning air bags repaired. This will help to make sure the air bags continue to perform their protective function for the vehicle occupants in the event of a crash.

WARNING

Pyrotechnic Emergency Tensioning Devices that have been deployed are no longer operational and are unable to perform their intended protective function. This poses an increased risk of injury or even fatal injury.

Therefore, have pyrotechnic Emergency Tensioning Devices which have been triggered immediately replaced at a qualified specialist workshop.

If the Emergency Tensioning Devices or air bags are deployed, you will hear a bang and a small amount of powder may also be released. The  restraint system warning lamp will light up.

Only in rare cases will the bang affect your hearing. The powder released is generally not hazardous to health, it could however cause short-term breathing difficulties in people with asthma or other respiratory problems. If it is safe to do so, you should leave the vehicle immediately or open a window in order to prevent breathing difficulties.

Air bags and pyrotechnic Emergency Tensioning Devices (ETDs) contain perchlorate material, which may require special handling and regard for the environment. Check with your local government's disposal guidelines. California residents, see www.dtsc.ca.gov/HazardousWaste/Perchlorate/index.cfm.

Method of operation

During the first stage of a collision, the restraint system control unit evaluates important physical data relating to vehicle deceleration or acceleration, such as:

- Duration
- Direction
- Intensity

Based on the evaluation of this data, the restraint system control unit triggers the Emergency Tensioning Devices in the event of a frontal or rear-end collision.

An Emergency Tensioning Device can only be triggered if:

- the ignition is switched on
- the components of the restraint system are operational. You can find further information under "Restraint system warning lamp" (▷ page 39)
- the belt tongue is inserted into the buckle on the respective front seat

The Emergency Tensioning Device of the co-driver's seat is triggered independently of the lock status of the seat belt.

If the restraint system control unit detects a high accident severity, additional components of the restraint system are deployed independently of one another in certain frontal collision situations:

- Front air bags
- Window curtain air bag on side of collision

The deployment thresholds for the Emergency Tensioning Devices and air bags are calculated on the basis of the vehicle deceleration or acceleration occurring at various points in the vehicle. This process is pre-emptive in nature. The air bag must be deployed on time, at the start of the collision.

The rate of vehicle deceleration or acceleration and the direction of the force are essentially determined by:

- distribution of the force during the impact
- collision angle
- deformation characteristics of the vehicle
- characteristics of the object with which the vehicle has collided

Factors which can only be seen and measured after the collision has occurred do not play a decisive role in the deployment of an air bag, nor do they provide an indication of air bag deployment.

The vehicle may be considerably deformed without an air bag being deployed. This is the case if only relatively easily deformable parts have been hit and a high rate of deceleration has not been reached. Conversely, an air bag may be deployed even though the vehicle suffers only minor deformation. This is the case if, for example, very rigid vehicle parts such as the longitudinal body members are hit in an accident and the rate of deceleration is sufficient.

If the restraint system control unit detects a side impact situation, the applicable components of the restraint system are deployed independently of each other. If the system determines a need for additional protection for the vehicle occupants, the Emergency Tensioning Devices are also deployed.

- Side impact air bag on the side on which the impact occurs, independently of the Emergency Tensioning Device and of the use of the seat belt
- Window curtain air bag on the side of the collision, regardless of seat belt use and whether front-passenger seat is occupied

i Not all air bags are deployed in an accident. The various air bag systems work independently of each other.

How the air bag system works is determined by the severity of the accident detected, especially the vehicle deceleration or acceleration, and the apparent type of accident:

- frontal collision
- side impact

Children in the vehicle

Important safety notes

Accident statistics show that children secured in the rear seats are safer than children secured in the front-passenger seat. For this reason, we strongly advise that you install a child restraint system on a rear seat. Children are generally better protected there.

If a child younger than twelve years old and under 5 ft (1.50 m) in height is traveling in the vehicle:

- always secure the child in a child restraint system suitable for this vehicle. The child restraint system must be appropriate to the age, weight and size of the child
- be sure to observe the instructions and safety notes in this section in addition to the child restraint system manufacturer's installation instructions

WARNING

If you leave children unsupervised in the vehicle, they could set it in motion by, for example:

- release the parking brake.
- shift the automatic transmission out of the parking position **P**.
- start the engine.

In addition, they may operate vehicle equipment and become trapped. There is a risk of an accident and injury.

When leaving the vehicle, always take the SmartKey with you and lock the vehicle. Never leave children unsupervised in the vehicle.

WARNING

If persons, particularly children are subjected to prolonged exposure to extreme heat or cold, there is a risk of injury, possibly even fatal. Never leave children unattended in the vehicle.

WARNING

If the child restraint system is subjected to direct sunlight, parts may get very hot. Children may burn themselves on these parts, particularly on the metal parts of the child restraint system. There is a risk of injury.

If you leave the vehicle, taking the child with you, always ensure that the child restraint system is not exposed to direct sunlight. Protect it with a blanket, for example. If the child restraint system has been exposed to direct sunlight, let it cool down before securing the child in it. Never leave children unattended in the vehicle.

Always ensure that all vehicle occupants have their seat belts fastened correctly and are sitting properly. Particular attention must be paid to children.

Observe the safety notes on the seat belt (> page 40) and the notes on correct use of seat belts (> page 41).

A booster seat may be necessary to achieve proper seat belt positioning for children over 41 lbs (18 kg) until they reach a height where a

three-point seat belt can be properly fastened without a booster seat.

Special seat belt retractor

WARNING

If the seat belt is released while driving, the child restraint system will no longer be secured properly. The special seat belt retractor is disabled and the inertia reel draws in a portion of the seat belt. The seat belt cannot be immediately refastened. There is an increased risk of injury, possibly even fatal. Stop the vehicle immediately, paying attention to road and traffic conditions. Reactivate the special seat belt retractor and secure the child restraint system properly.

All seat belts in the vehicle, except the driver's seat belt, are equipped with a special seat belt retractor. When activated, the special seat belt retractor ensures that the seat belt cannot slacken once the child seat is secured.

Installing a child restraint system:

- ▶ Make sure you observe the child restraint system manufacturer's installation instructions.
- ▶ Pull the seat belt smoothly from the belt outlet.
- ▶ Engage seat belt tongue in belt buckle.

Activating the special seat belt retractor:

- ▶ Pull the seat belt out fully and let the inertia reel retract it again. While the seat belt is retracting, you should hear a ratcheting sound. The special seat belt retractor is enabled.
- ▶ Push the child restraint system down so that the seat belt is tight and does not loosen.

Removing the child restraint system and deactivating the special seat belt retractor:

- ▶ Make sure you observe the child restraint system manufacturer's installation instructions.
- ▶ Press the release button of the seat belt buckle and guide the seat belt tongue back towards the belt sash guide. The special seat belt retractor is deactivated.

Child restraint system

The use of seat belts and infant and child restraint systems is required by law in:

- all 50 states
- the U.S. territories
- the District of Columbia
- all Canadian provinces

Further information about the correct child restraint system is available from any authorized Sprinter dealer.

WARNING

If the child restraint system is installed incorrectly on a suitable seat, it cannot protect as intended. The child cannot then be restrained in the event of an accident, heavy braking or sudden changes of direction. There is an increased risk of injury, possibly even fatal.

Make sure that you observe the child restraint system manufacturer's installation instructions and the notes on use. Please ensure, that the base of the child restraint system is always resting completely on the seat cushion. Never place objects, e.g. cushions, under or behind the child restraint system. Only use child restraint systems with the original cover designed for them. Only replace damaged covers with genuine covers.

WARNING

If the child restraint system is installed incorrectly or is not secured, it can come loose in the event of an accident, heavy braking or a sudden change in direction. The child restraint system could be thrown about, striking vehicle occupants. There is an increased risk of injury, possibly even fatal.

Always install child restraint systems properly, even if they are not being used. Make sure that you observe the child restraint system manufacturer's installation instructions.

You will find further information on stowing objects, luggage and loads securely under "Loading guidelines" (> page 212).

⚠ WARNING

Child restraint systems or their securing systems which have been damaged or subjected to a load in an accident can no longer protect as intended. The child cannot then be restrained in the event of an accident, heavy braking or sudden changes of direction. There is an increased risk of injury, possibly even fatal.

Replace child restraint systems which have been damaged or subjected to a load in an accident as soon as possible. Have the securing systems on the child restraint system checked at a qualified specialist workshop, before you install a child restraint system again.

Securing systems for child restraint systems include:

- the seat belt system
- the LATCH-type (ISOFIX) securing rings
- Top Tether anchorage points

i If it is absolutely necessary to install a child restraint system on the front-passenger seat, be sure to observe the notes on "Child restraint systems on the front-passenger seat" (▷ page 51).

All child restraint systems must meet the following standards:

- U.S. Federal Motor Vehicle Safety Standards 213 and 225
- Canadian Motor Vehicle Safety Standards 213 and 210.2

A statement by the child restraint manufacturer of compliance with these standards can be found on the instruction label on the child restraint system. You will also find the statement in the instruction manual provided with the child restraint system.

Observe the warning labels in the vehicle interior and on the child restraint system.

LATCH-type (ISOFIX) child seat securing system**⚠ WARNING**

LATCH-type (ISOFIX) child restraint systems do not offer sufficient protective effect for children whose weight is greater than 48 lbs (22 kg) who are secured using the safety belt integrated in the child restraint system. In the event of an accident, a child might not be restrained correctly. This poses an increased risk of injury or even fatal injury.

If the child weighs more than 48 lbs (22 kg), only use LATCH-type (ISOFIX) child restraint systems with which the child is also secured with the vehicle seat belt. Also secure the child restraint system with the Top Tether belt, if available.

Always comply with the manufacturer's installation and operating instructions for the child restraint system used.

Before every trip, make sure that the LATCH-type (ISOFIX) child restraint system is engaged correctly in both LATCH-type (ISOFIX) securing rings

! When installing the child restraint system, make sure that the seat belt for the middle seat does not get trapped. The seat belt could otherwise be damaged.



- ▶ Install the LATCH-type (ISOFIX) child restraint system on both LATCH-type (ISOFIX) securing rings ①.

ISOFIX is a standardized securing system for specially designed child restraint systems on the rear seats. LATCH-type (ISOFIX) securing rings ① for a LATCH-type (ISOFIX) child restraint system are installed between the seat cushion and the seat backrest:

- on the outer left and right seat on rear bench seats with 3 seats
- on the outer left seat on rear bench seats with 2 seats

Non-LATCH-type (ISOFIX) child seats may also be used and can be installed using the vehicle's seat belt system. Install the child seat according to the manufacturer's instructions.

Top Tether

Introduction

Top Tether provides an additional connection between the LATCH-type (ISOFIX) child restraint system and the vehicle. This helps reduce the risk of injury even further. If the child restraint system has a Top Tether belt, this should be used at all times.

Important safety notes

WARNING

If the Top Tether belt has been incorrectly secured, e.g. to an eyelet in the cargo compartment, the child restraint system is not correctly kept in place. It therefore cannot perform its intended protective function in the event of an accident. There is an increased risk of injury.

Only secure the Top Tether hook to the Top Tether anchorage intended for this purpose.

Top Tether anchorage points

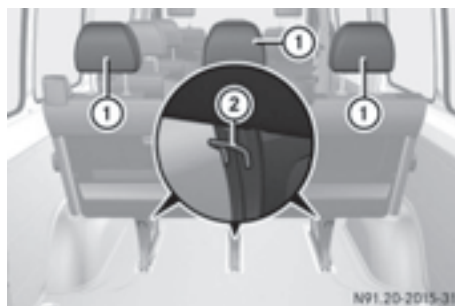

Example: rear bench seat with 3 seats

Top Tether anchorages ② are on the bench seat legs on the rear side of the respective rear bench seat.

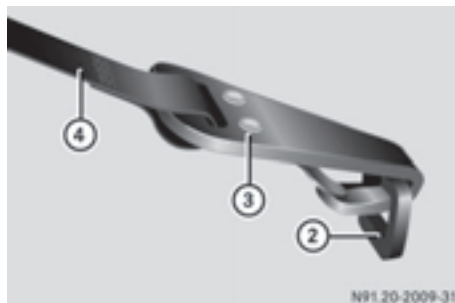

- ▶ Slide head restraint ① upwards.
- ▶ Install the LATCH-type (ISOFIX) child restraint system with Top Tether. Make sure you observe the child restraint system manufacturer's installation instructions.
- ▶ Route the Top Tether belt ④ under head restraint ① between the two head restraint bars.
- ▶ Hook Top Tether hook ③ into Top Tether anchorage ②.
 - Make sure that:
 - the Top Tether hook ③ is hooked into Top Tether anchorage ②, as shown
 - Top Tether belt ④ is not twisted
- ▶ Tighten Top Tether belt ④. Make sure you observe the child restraint system manufacturer's installation instructions.
- ▶ If necessary, push the head restraint back down slightly (▷ page 76). Make sure that you do not interfere with the correct routing of Top Tether belt ④.

Child restraint system on the front-passenger seat

General notes

Accident statistics show that children secured in the rear seats are safer than children secured in the front-passenger seat. For this reason, Mercedes-Benz strongly advises that you install the child restraint system on a rear seat.

Rearward-facing child restraint system

The front-passenger front air bag cannot be deactivated. Always install a rearward-facing child restraint system on a suitable rear seat. Always observe the child restraint system manufacturer's installation and operating instructions.

Forward-facing child restraint system

If it is absolutely necessary to install a forward-facing child restraint system on the front-passenger seat, always move the front-passenger seat as far back as possible. The entire base of the child restraint system must always rest on the seat cushion of the front-passenger seat. The backrest of the child restraint system must lie as flat as possible against the backrest of the front-passenger seat. The child restraint system must not be subjected to a load by the head restraint. Adjust the head restraint position accordingly. Always make sure that the shoulder belt strap is correctly routed from the vehicle belt outlet to the shoulder belt guide on the child restraint system. The shoulder belt strap must be routed forwards and downwards from the vehicle belt outlet. If necessary, adjust the vehicle belt outlet and the front-passenger seat accordingly. Always observe the child restraint system manufacturer's installation and operating instructions.

Override features/Child-proof locks

Important safety notes

WARNING

If children are traveling in the vehicle, they could:

- open doors, thus endangering other people or road users
- exit the vehicle and be caught by oncoming traffic
- operate vehicle equipment and become trapped

There is a risk of an accident and injury.

Always activate the child-proof locks and override feature if children are traveling in the vehicle. When leaving the vehicle, always take the key with you and lock the vehicle. Never leave children unattended in the vehicle.

Child-proof locks for rear doors (▷ page 52).

WARNING

If you leave children unsupervised in the vehicle, they could set it in motion by, for example:

- release the parking brake.
- shift the automatic transmission out of the parking position **P**.
- start the engine.

In addition, they may operate vehicle equipment and become trapped. There is a risk of an accident and injury.

When leaving the vehicle, always take the SmartKey with you and lock the vehicle. Never leave children unsupervised in the vehicle.

WARNING

If persons, particularly children are subjected to prolonged exposure to extreme heat or cold, there is a risk of injury, possibly even fatal. Never leave children unattended in the vehicle.

WARNING

If the child restraint system is subjected to direct sunlight, parts may get very hot. Chil-

dren may burn themselves on these parts, particularly on the metal parts of the child restraint system. There is a risk of injury.

If you leave the vehicle, taking the child with you, always ensure that the child restraint system is not exposed to direct sunlight. Protect it with a blanket, for example. If the child restraint system has been exposed to direct sunlight, let it cool down before securing the child in it. Never leave children unattended in the vehicle.

Child-proof locks for the rear door



Rear door

- ① Child safety bolt
- ② Door secured – then make sure that the child-proof locks are working properly.
- ③ Door released

The child-proof lock on the doors enable you to secure each door individually.

A door with an activated child-proof lock cannot be opened from the inside. If the vehicle is unlocked, the door can be opened from the outside.

Pets in the vehicle

WARNING

If you leave animals unattended or unsecured in the vehicle, they could press buttons or switches, for example.

As a result, they could:

- activate vehicle equipment and become trapped, for example
- activate or deactivate systems, thereby endangering other road users

Unsecured animals could also be flung around the vehicle in the event of an accident or sudden steering or braking, thereby injuring vehicle occupants. There is a risk of an accident and injury.

Never leave animals unattended in the vehicle. Always secure animals properly during the journey, e.g. use a suitable animal transport box.

Driving safety systems

Overview

In this section, you will find information about the following driving safety systems:

- ABS (**A**nti-**l**ock **B**raking **S**ystem)
- ASR (**A**cceleration **S**kid **C**ontrol)
- BAS (**B**rake **A**ssist **S**ystem)
- EBD (**E**lectronic **B**rake **F**orce **D**istribution)
- ESP® (**E**lectronic **S**tability **P**rogram)

Important safety notes

If you fail to adapt your driving style or if you are inattentive, the driving safety systems can neither reduce the risk of accident nor override the laws of physics. Driving safety systems are merely aids designed to assist driving. You are responsible for the distance to the vehicle in front, for vehicle speed, braking in good time and for staying in your lane. Always adapt your driving style to the prevailing road and weather conditions and maintain a sufficient, safe distance from other road users. Drive carefully.

Please note that the driving safety systems described only work optimally when:

- there is adequate contact between the tires and the road surface
- you use winter tires (M+S tires), with snow chains if necessary, when the road conditions are wintry.

Pay particular attention to the information regarding tires, tire tread and winter operation under "Wheels and tires" (▷ page 247).

ABS (Anti-lock Braking System)

Important safety notes

Observe the important safety guidelines for the driving safety system (▷ page 52).

WARNING

If ABS is faulty, the wheels could lock when braking. The steerability and braking characteristics may be severely impaired. Additionally, further driving safety systems are deactivated. There is an increased danger of skidding and accidents.

Drive on carefully. Have ABS checked immediately at a qualified specialist workshop.

If ABS is malfunctioning, other systems will also fail, including driving safety systems. Observe the information relating to the  warning lamp (▷ page 195).

ABS regulates brake pressure in such a way that the wheels do not lock when you brake. This allows you to continue steering the vehicle when braking.

ABS works from a speed of about 5 mph (8 km/h), regardless of road-surface conditions. ABS works on slippery surfaces, even when you only brake gently.

The yellow  warning lamp in the instrument cluster lights up when the ignition is switched on. The lamp goes out when the engine starts running.

Braking

If ABS intervenes when braking, you will feel a pulsating in the brake pedal.

The pulsating brake pedal can be an indication of hazardous road conditions and functions as a reminder to take extra care while driving.

- ▶ **If ABS intervenes:** continue to depress the brake pedal with force until the braking situation is over.
- ▶ **To make a full brake application:** depress the brake pedal with full force.

ASR (acceleration skid control)

General notes

Important safety notes

Observe the important safety guidelines for the driving safety system (▷ page 52).

ASR can neither reduce the risk of an accident nor suspend the laws of physics if the driver does not pay attention when pulling away or accelerating. ASR is only an aid. Always adapt your driving style to suit the prevailing road and weather conditions.

If you activate or deactivate the all-wheel drive in a vehicle with this option, ASR will be deactivated for the duration of the activation/deactivation process.

Vehicles without steering wheel buttons: if ASR is malfunctioning, the  indicator lamp lights up while the engine is running and the engine power may be reduced (▷ page 195).

ASR significantly improves traction, i.e. the transmission of power from the tires to the road surface, and thus increases the vehicle's driving stability. If the driving wheels start to spin, ASR brakes individual drive wheels and limits the engine torque. ASR thus significantly assists you when pulling away and accelerating, especially on wet or slippery roads.

If traction on the road surface is not sufficient, even ASR will not allow you to pull away without difficulty. The type of tires and total weight of the vehicle as well as the gradient of the road also play a crucial role.

If ASR intervenes, the  warning lamp in the instrument cluster flashes.

Activating/deactivating ASR

WARNING

If deactivated, ASR will not attempt to stabilize the vehicle during pulling away and acceleration. There is an increased risk of skidding and of an accident.

Only deactivate ASR in the situations described in the following.

- ❗ If you deactivate ASR, ESP® will still intervene to stabilize the vehicle. Frequent braking automatically triggered by ESP® can damage the brake system.

For this reason, deactivate ASR only briefly and when absolutely necessary.



When ESP® is intervening and the  warning lamp in the instrument cluster is flashing, leave ASR on. In this case, only depress the accelerator pedal as far as required when pulling away.

▶ Press the  button.

If ASR is deactivated, the  warning lamp in the instrument cluster lights up.

ASR is automatically activated when the engine is started.

It may be best to deactivate ASR briefly in the following situations:

- when using snow chains
- in deep snow
- on sand or gravel

If you deactivate ASR:

- engine torque is not limited and the drive wheels are able to spin. The spinning wheels will then achieve a cutting effect for better traction.
- traction control remains active through brake intervention. If a drive wheel attains its tire traction limit because one side of the road is slippery, for example, that wheel is braked. The traction is then increased in this situation.
- active brake intervention by ESP® to increase driving stability remains active. The  warning lamp in the instrument cluster flashes when ESP® is intervening.

BAS (Brake Assist System)

WARNING

If BAS is malfunctioning, the braking distance in an emergency braking situation is increased. There is a risk of an accident.

In an emergency braking situation, depress the brake pedal with full force. ABS prevents the wheels from locking.

Vehicles without steering wheel buttons: if the BAS driving safety system is malfunctioning, the  warning lamp lights up while the engine is running (▷ page 195).

BAS operates in emergency braking situations. If you depress the brake quickly, BAS automatically increases the brake pressure, thereby reducing the stopping distance.

The brakes will function as usual once you release the brake pedal. BAS is deactivated.

EBD (electronic brake force distribution)

WARNING

If EBD is malfunctioning, the rear wheels can lock, e.g. under full braking. This increases the risk of skidding and an accident.

You should therefore adapt your driving style to the different handling characteristics. Have the brake system checked at a qualified specialist workshop.

EBD monitors and controls the brake pressure to the rear wheels. This enables EBD to improve handling during braking.

Observe the information on warning and indicator lamps (▷ page 195).

ESP® (Electronic Stability Program)

Important safety notes

WARNING

If ESP® is malfunctioning it will not provide any vehicle stabilization. There is an increased risk of skidding or of an accident.

Exercise caution when continuing to drive. Have ESP® checked at a qualified specialist workshop.

! Do not run the vehicle on a roller dynamometer (e.g. for performance tests). If you must operate the vehicle on a roller dynamometer,

please consult a qualified specialist workshop in advance. You could otherwise damage the drive train or the brake system.

If you activate or deactivate the all-wheel drive in a vehicle with this option, ESP® will be deactivated for the duration of the activation/deactivation process.

If ESP® is malfunctioning, the  indicator lamp lights up while the engine is running and the engine power may be reduced (▷ page 194).

- ❗ Only use wheels with the recommended tire sizes. Only then will ESP® function properly.

4ETS (Electronic Traction System)

- ❗ A function or performance test should only be carried out on a two-axle dynamometer. Before you operate the vehicle on such a dynamometer, please consult a qualified workshop. You could otherwise damage the drive train or the brake system.

4ETS is only active when all-wheel drive is activated (▷ page 148).

4ETS ensures permanent drive for all four wheels, and together with ESP® it improves the vehicle's traction.

If a driven wheel spins due to lack of traction:

- When pulling away, make use of the traction control integrated in ESP®. Depress the accelerator pedal as far as necessary.
- While driving, slowly take your foot off the accelerator pedal.

In wintry driving conditions, always use winter tires (M+S tires) and if necessary, snow chains (▷ page 249). This is the only way to get the full benefit from the all-wheel drive system.

Crosswind Assist

Crosswind Assist does not work if ESP® is deactivated or disabled because of a malfunction.

Crosswind Assist does not react:

- in the event of severe jolts and vibrations, e.g. as a result of uneven surfaces or potholes
- if the vehicle loses traction, e.g. on snow or ice or when aquaplaning
- to large and sudden steering movements by the driver

Crosswind Assist is operational again as soon as the driving conditions return to normal.

Crosswind Assist detects strong crosswind gusts that can impair the road holding of your vehicle when driving straight ahead. Crosswind Assist intervenes depending on the direction and strength of the crosswind.

A stabilizing brake application helps you to keep the vehicle on track.

Information appears in the instrument cluster in the event that Crosswind Assist intervenes noticeably.

On vehicles without steering wheel buttons: the  indicator lamp in the instrument cluster flashes.

On vehicles with steering wheel buttons: the  indicator lamp in the instrument cluster flashes and the message **Crosswind Assist Active** appears in the multifunction display.

Crosswind Assist is active above a vehicle speed of 50 mph (80 km/h) when the vehicle is driving straight ahead or cornering gently.

Emergency exit

Emergency exit window

WARNING

The emergency exit window cannot be locked in place. You risk injury if you exit the vehicle through the emergency exit window.

- Make sure that nobody becomes trapped, both when closing and when opening the emergency exit window.
- The opened emergency exit window must be held in place by another person.

Pay attention to traffic conditions.

WARNING

If the emergency exit window is unlocked while driving, it could open and slam shut and consequently fall down. There is a risk of an accident and injury.

Before starting off, make sure that the emergency exit window is locked and the locking pins are undamaged.

- ❗ Make sure there is sufficient clearance when opening the emergency exit window.

Hold the open window in position. You could otherwise damage the emergency exit window.

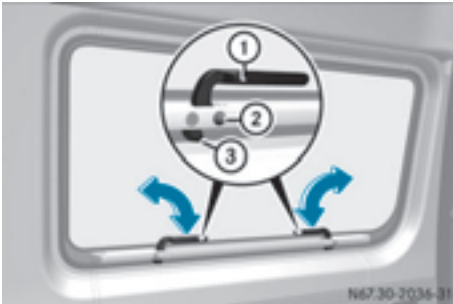

The emergency exit window is intended for use in an emergency only and must not be opened unless the vehicle is stationary. The emergency exit window is the first window behind the driver's seat on the driver's side. It is marked by the "Emergency Exit" label.

- ▶ **To open:** position both handles ① vertically. This will break locking pins ②. The window is unlocked.
- ▶ Swing the window outward by the handles and hold it in this position. Make sure there is sufficient clearance when doing so.
- ▶ **To close:** close the window.
- ▶ Position both handles ① horizontally. Make sure that the locks ③ are inside in front of the window frame. The window is locked.
- ▶ Replace locking pins ② at the latest before starting on a new journey. You can obtain information on this at any qualified specialist workshop.

In an emergency, or after an accident, the vehicle occupants can exit the vehicle through the emergency exit window.

Observe the following notes to make sure that the emergency exit window can be used safely in the event of an emergency:

- Before beginning a journey, inform the vehicle occupants of the emergency exit window and explain how to use it. Make sure to explicitly point out the risks described here.
- Only vehicle occupants who know how to use the emergency exit window are permitted to sit next to it.
- Access to the emergency exit window must remain unobstructed. Do not place any large

or heavy objects on or in front of the seats next to the emergency exit window.

- The window handles must not be used as hooks, e.g. to hang up light objects, bags or items of clothing.
- When exiting the vehicle through the emergency exit window, pay attention to the vehicle height and the local conditions. Particularly children and smaller adults may require assistance when exiting the vehicle.

Theft deterrent locking system

Immobilizer

- ▶ **To activate:** remove the key from the ignition lock.
- ▶ **To deactivate:** turn the key to position 2 in the ignition lock.

The immobilizer prevents your vehicle from being started without the correct key.

Always take the key with you and lock the vehicle when leaving the vehicle. If you leave the key in the vehicle, anyone can start the engine.

i The immobilizer is always deactivated when you start the engine.

In the event that the engine cannot be started when the starter battery is fully charged, the immobilizer may be faulty. Contact an authorized Sprinter dealer or call 1-877-762-8267 (in USA) or 1-800-387-0100 (in Canada).

ATA (Anti-Theft Alarm system)

- ▶ **To arm:** close all doors.
- ▶ Lock the vehicle with the key. The indicator lamp in the central locking button (▷ page 64) flashes.
- ▶ **To disarm:** unlock the vehicle with the key. The indicator lamp in the central locking button (▷ page 64) goes out.

i Cargo Van and Passenger Van only:

Unless you open a door within 40 seconds after unlocking the vehicle:

- the vehicle will be locked again
- the anti-theft alarm system will be armed again

If the alarm system is armed, a visual and audible alarm is triggered by the following:

- Unlocking the vehicle from inside
- Opening a door
- Opening the hood

i The alarm is not switched off, even if you immediately close the open door that has triggered it, for example.

▶ **To stop the alarm:** press the  button on the remote control.

or

▶ Insert the key into the ignition lock.
The alarm stops.

Tow-away alarm

Operation

A visual and audible alarm is triggered if the inclination of the vehicle changes when the tow-away alarm is armed. This can be the case if the vehicle is raised on one side, for example.

Arming and disarming

The tow-away alarm is automatically armed approximately 20 seconds after you lock the vehicle.

The tow-away alarm is automatically deactivated when you unlock the vehicle.

Disarming



▶ Remove the key from the ignition lock.

▶ Press button ①.

When the button is released, indicator lamp ② in the button lights up for about 5 seconds.

▶ Lock the vehicle.

The tow-away alarm is disarmed.

The tow-away alarm remains disarmed until you lock the vehicle again.

Disarm the tow-away alarm when locking your vehicle and:

- loading and/or transporting the vehicle, on a ferry or car transporter, for example
- parking on a moving surface, as split-level garage

This will prevent false alarms.

Interior motion sensor

Operation

If the armed interior motion sensor detects motion in the vehicle interior, a visual and acoustic alarm is triggered. This can happen if someone reaches into the vehicle interior, for example.

Switching on

▶ Close the side windows.

▶ Make sure that nothing (such as mascots or coat hangers) are hanging on the rear-view mirror or on the grab handles on the headliner.

This will prevent false alarms.

▶ Lock the vehicle.

The interior motion sensor is armed after approximately 40 seconds.

Switching off

▶ Unlock vehicle.

The interior motion sensor automatically switches off.

N54 25-3094-3E

Deactivating



- ▶ Remove the key from the ignition lock.
- ▶ Press button ①.
When the button is released, indicator lamp ② of the button lights up for about 5 seconds.
- ▶ Lock the vehicle.
The interior motion sensor is deactivated.

The interior motion sensor remains deactivated until you lock the vehicle again.

Deactivate the interior motion sensor when locking your vehicle:

- with people or animals remaining inside
- with the side windows remaining open
- when transporting it on a ferry or car transporter, for example

This will prevent false alarms.

Useful information

This Operator's Manual describes all models as well as standard and optional equipment of your vehicle that were available at the time of going to print. Country-specific variations are possible. Note that your vehicle may not be equipped with all of the described functions. This also applies to systems and functions relevant to safety.

Read the information on qualified specialist workshops (▷ page 26).

Key

Important safety notes

WARNING

When the double locks are activated, the doors can no longer be opened from the inside. People in the vehicle can no longer get out, e.g. in hazardous situations. There is a risk of injury.

Therefore, do not leave any people unsupervised in the vehicle, particularly children, elderly people or people in need of special assistance. Do not activate the double lock when people are in the vehicle.

WARNING

If you leave children unsupervised in the vehicle, they could set it in motion by, for example:

- release the parking brake.
- shift the automatic transmission out of park position **P** or shift manual transmission into neutral.
- start the engine.

In addition, they may operate vehicle equipment and become trapped. There is a risk of an accident and injury.

When leaving the vehicle, always take the SmartKey with you and lock the vehicle. Never leave children unsupervised in the vehicle.

WARNING

If you attach heavy or large objects to the SmartKey, the SmartKey could be unintentionally turned in the ignition lock. This could cause the engine to be switched off. There is a risk of an accident.

Do not attach any heavy or large objects to the SmartKey. Remove any bulky key rings before inserting the SmartKey into the ignition lock.

Do not keep the key with remote control:

- with electronic devices, e.g. a mobile phone or another key with remote control
- with metallic objects, e.g. coins or metal foil
- in metallic objects, e.g. metal cases

This can affect the key's functionality.

Key functions of the remote control

General notes

The vehicle is equipped with either 2 or 4 remote controls with a folding key, or 4 mechanical keys. In this Operator's Manual, both the mechanical keys and the keys with remote control are referred to as keys. The remote control key has a range of up to 32 ft (10 m). Use the remote control of the key only when in immediate proximity of the vehicle. This prevents theft.

Remote controls that are not included in the scope of delivery for the vehicle must be programmed before use. Further information can be obtained at any authorized Sprinter Dealer.

The key's remote control locks/unlocks the driver's door and/or the following centrally if the factory settings have not been changed:

- the driver's and the front-passenger door
- the sliding doors
- the rear doors

i If the driver's or front-passenger door is not closed, the corresponding door is not locked. If a sliding door or a rear door is not closed properly, none of the rear doors are locked.

If there is a key in the ignition lock, the remote control is inoperative. When locking or unlocking the vehicle with the remote control, always pay attention to the indicator lamp signaling. Also check the locking knobs of the doors.

Unlocking/locking the vehicle with the remote control



Remote control with an integrated folding key

- ① To unlock the sliding doors and the rear door
- ② To unlock the driver's door only or unlock the vehicle centrally
- ③ To lock the vehicle centrally
- ④ Key release button
- ⑤ Battery check lamp

► **To unlock the driver's door:** press the button.

The turn signals flash once. The theft deterrent locking system is deactivated.

► **To unlock the sliding doors and the rear door:** press the button.

The turn signals flash once.

► **To unlock centrally:** unlock the driver's door.

► Press the button again within 2 seconds.

The turn signals flash once.

i If the surround lighting has been switched on using the on-board computer (> page 172), it goes on when the vehicle is unlocked.

If you do not open a Cargo Van or Passenger Van within approximately 40 seconds of unlocking:

- the vehicle is locked again.
- the theft deterrent locking system is armed again.

► **To lock centrally:** press the button.

The indicator lamps flash three times when the theft deterrent locking system has been armed and all doors have been closed.

► Check the locking knobs on all the doors.

The locking knobs must all be in the lowered position.

Unlocking/locking the vehicle with the mechanical key or the folding key

The anti-theft alarm system (ATA) is triggered if you unlock and open the driver's door or the rear door with the mechanical key or the folding key.

The alarm can be disabled in the following two ways:

► Press the or button on the remote control.

Or

► Insert the key into the ignition lock.

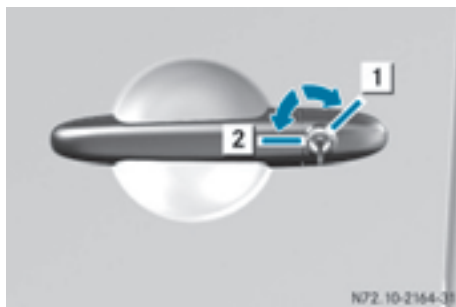

Driver's door

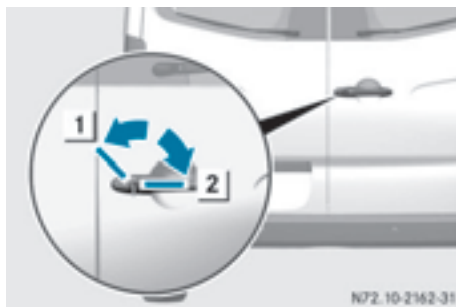

Rear door

- 1** Locked
- 2** Unlocked

- ▶ **To unlock the driver's or rear door:** press the key release button on the remote control. The key folds out.
- ▶ Insert the key fully into the door lock and turn it to position ②. The door is unlocked.
- ▶ **To lock the vehicle:** lock all doors except the driver's door and, if necessary the rear door, from inside. To do this, press down the door locking buttons.
- ▶ Press the key release button on the remote control. The key folds out.
- ▶ Insert the key fully into the driver's door lock and turn it to position ①. The driver's door is locked.

Remote control battery

Important safety notes

WARNING

Batteries contain toxic and corrosive substances. If batteries are swallowed, it can result in severe health problems. There is a risk of fatal injury.

Keep batteries out of the reach of children. If a battery is swallowed, seek medical attention immediately.

Environmental note



Batteries contain dangerous substances. It is against the law to dispose of them with the household rubbish. They must be collected separately and recycled to protect the environment.







Dispose of batteries in an environmentally friendly manner. Take discharged batteries to a qualified specialist workshop or a special collection point for used batteries.

for the environment. Check with your local government's disposal guidelines. California residents, see www.dtsc.ca.gov/HazardousWaste/Perchlorate/index.cfm.

We recommend that you have batteries changed at a qualified specialist workshop.

Checking the batteries

- ▶ Press the  or  button for longer than two seconds. If battery indicator lamp (▷ page 59) lights up briefly, the batteries in the remote control still have sufficient charge. Otherwise, change the batteries immediately.

i If the remote control is checked within the signal reception range of the vehicle, pressing the  or  button:

- lock or
- unlock the vehicle

Changing batteries

You need a CR 2025 2 3 V cell battery, which can be obtained from any qualified specialist workshop.

When changing the batteries, do not press any of the buttons on the remote control.

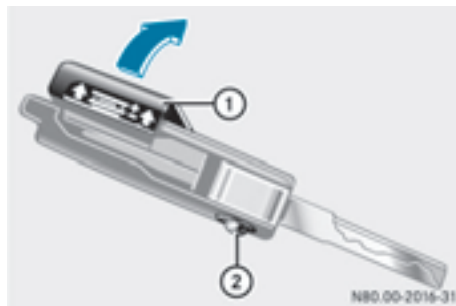

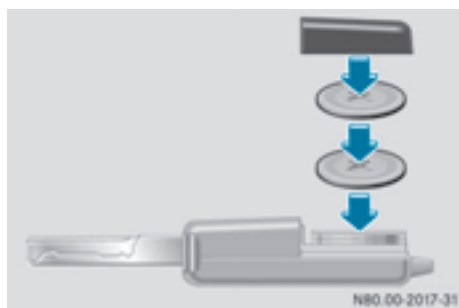

- ▶ Press release button ②. The key folds out.
- ▶ Remove battery compartment cover ① in the direction of the arrow.

The key batteries contain perchlorate material, which may require special handling and regard



- ▶ Remove the batteries from the battery tray.
- ▶ Insert the new batteries into the battery tray with the positive pole facing upwards. Use a lint-free cloth to do so.
- ▶ Align battery compartment cover ① and push it on until it audibly engages.
- ▶ Check the function of all the remote control buttons on the vehicle.

Problems with the key/remote control

Problem	Possible causes/consequences and ► Solutions
<p>It is no longer possible to lock the vehicle using the remote control.</p> <p>The turn signals do not flash when the vehicle is locked.</p>	<p>The doors are not closed properly.</p> <ul style="list-style-type: none"> ► Close the doors properly and lock the vehicle again. <p>The central locking system has malfunctioned.</p> <ul style="list-style-type: none"> ► Lock the vehicle using the folding key (▷ page 59). ► Have the central locking system checked as soon as possible at a qualified specialist workshop.
<p>It is no longer possible to lock or unlock the vehicle using the remote control.</p>	<p>The key battery is weak or discharged.</p> <ul style="list-style-type: none"> ► Point the remote control at the driver's door handle from very close range and press the  or  button. <p>If this does not work:</p> <ul style="list-style-type: none"> ► Replace the key battery (▷ page 61). <p>or</p> <ul style="list-style-type: none"> ► Lock the vehicle using the folding key (▷ page 59). <p>The remote control is faulty.</p> <ul style="list-style-type: none"> ► Lock the vehicle using the folding key (▷ page 59). ► Have the key checked at a qualified specialist workshop.
<p>The key cannot be turned in the ignition lock.</p>	<p>The steering lock has jammed mechanically.</p> <ul style="list-style-type: none"> ► Remove the key and insert it again into the ignition lock. Turn the steering wheel from side to side while doing so.
<p>The engine cannot be started using the key.</p>	<p>The on-board voltage is too low.</p> <ul style="list-style-type: none"> ► Switch off all non-essential consumers, such as interior lighting, and try to start the engine again. <p>If this does not work:</p> <ul style="list-style-type: none"> ► Check the starter battery and charge it if necessary (▷ page 232). <p>or</p> <ul style="list-style-type: none"> ► Jump-start the vehicle (▷ page 242). <p>or</p> <ul style="list-style-type: none"> ► Consult a qualified specialist workshop.
<p>You have lost a key.</p>	<ul style="list-style-type: none"> ► Have the key deactivated at a qualified specialist workshop. ► Report the loss immediately to the vehicle insurers. ► If necessary, have the mechanical locks replaced.

Central locking

Important safety notes

WARNING

Activate the child-proof door locks if children are traveling in the vehicle. The children could otherwise open the doors while the vehicle is in motion, injuring themselves and others.

WARNING

Do not leave children unsupervised in the vehicle, even if they are secured in a child restraint system. Children could otherwise injure themselves on parts of the vehicle. They could be severely or even fatally injured by prolonged exposure to intense heat or cold.

If children open a door, they could:

- injure other people
- get out of the vehicle and thereby injure themselves or be injured by a passing vehicle
- severely injure themselves by falling down, in particular due to the vehicle height

Always take the key with you when leaving the vehicle, even if you are only leaving for a short time.



You can open a locked front door from the inside at any time. You can open a locked sliding door or rear door from the inside if it has been previously unlocked from inside.

Locking and unlocking manually





Central locking buttons

Use the central locking buttons to centrally lock/unlock either the entire vehicle or just the sliding doors and rear doors from the inside.

- **To lock/unlock the entire vehicle:** press the upper  central locking button when the doors are closed. When the entire vehicle is locked, the indicator lamp in the  central locking button lights up.

- i** If the key has been removed or is in position **0** in the ignition lock, the indicator lamp in the  central locking button remains lit for 5 seconds.

- **To lock/unlock the sliding doors and rear doors:** press the lower section of the  central locking button when the doors are closed. When the sliding doors and rear doors are locked, the indicator lamp in the upper  central locking button lights up.

Automatic locking

General notes

The vehicle locks automatically as standard once a speed of 9 mph (15 km/h) has been reached. Depending on the vehicle's equipment, the doors may be locked automatically once the ignition is switched on. Information on the functions of the automatic locking mechanism of your vehicle can be obtained from any authorized Sprinter Dealer.

If the automatic locking when driving function is activated, there is a risk of being locked out when the vehicle is pushed or towed.



For this reason, deactivate the automatic locking when driving function:

- before pushing the vehicle
- before towing the vehicle



If activated, automatic locking is deactivated when the vehicle is unlocked or locked using the central locking button.

Automatic locking is reactivated after the ignition is switched off or a door is opened with the vehicle stationary.

Activating automatic locking when driving

- ▶ Turn the key to position **1** or **2** in the ignition lock when the doors are closed.
- ▶ **For the entire vehicle:** press the upper  central locking button until the indicator lamp in the button flashes four times.
- ▶ **For the sliding doors and rear doors only:** press the  lower central locking button until the indicator lamp in the  upper button flashes four times.

Deactivating automatic locking when driving

- ▶ Turn the key to position **1** or **2** in the ignition lock when the doors are closed.
- ▶ **For the entire vehicle:** press the  upper central locking button until the indicator lamp in the button flashes twice.
- ▶ **For the sliding doors and rear doors only:** press the  lower central locking button until the indicator lamp in the  upper button flashes twice.

Driver's door and front-passenger door

- ▶ **!** Only open the doors when road and traffic conditions permit. Make sure that there is sufficient clearance when opening the doors. Otherwise, you could damage your vehicle or other vehicles.

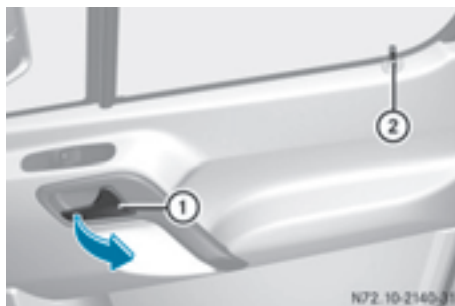

You can open the driver's or front-passenger door from the inside at any time, even if it is locked.

- ▶ Pull door handle **1**. Locking knob **2** pops up. The door opens.

Sliding door

Important safety notes

WARNING

If the open sliding door is not engaged, it could move on its own if the vehicle is on a slope. This could trap you or other persons. There is a risk of injury.

Always make sure that the open sliding door is engaged.

- ▶ **!** Only open the doors when road and traffic conditions permit. Make sure that there is sufficient clearance when opening the doors. Otherwise, you could damage your vehicle or other vehicles.

The sliding door of your vehicle can be equipped with an electrical access step. Observe the notes on the electrical step when opening and closing the sliding door (▷ page 66).

Opening/closing from the outside

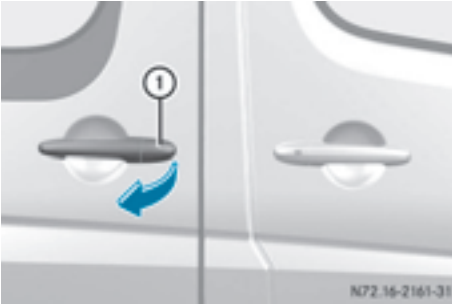

The sliding door is equipped with an active retainer, which engages the door at the end stop when opened.

i You can also lock the sliding door in place around halfway when opening and closing. The door does not have to be opened fully when getting into or out of the vehicle. The intermediate detent does not fully engage the sliding door.

- ▶ **To open:** pull door handle ①. The sliding door opens.
- ▶ Push back the sliding door using door handle ① until it engages.
- ▶ Check the sliding door detent.
- ▶ **To close:** slide the sliding door firmly forwards by handle ① until it closes.

Opening/closing from the inside



Interior door handle on the sliding door

The sliding door is equipped with an active retainer, which engages the door at the end stop when opened.

i You can also lock the sliding door in place around halfway when opening and closing.

The door does not have to be opened fully when getting into or out of the vehicle. The intermediate detent does not fully engage the sliding door.

- ▶ **To unlock:** pull locking knob ③ upwards. Only this sliding door unlocks. The other doors remain locked.
- ▶ **To open:** press button ①.
- ▶ Slide the sliding door by handle ② back to the stop.
- ▶ Check the sliding door detent. The sliding door must be engaged.
- ▶ **To close:** slide the sliding door firmly forwards by door handle ② until it engages.
- ▶ **To lock:** press locking knob ③ down. Only the sliding door is locked. All other doors that were previously unlocked remain unlocked.

Electrical closing assist

If your vehicle is equipped with electrical closing assist, you will require less force to close the sliding door.

Electrical step

Important safety notes

! Always observe the ground clearance of the vehicle and avoid obstacles. On vehicles with a step, ground clearance is further restricted. Obstacles can damage the vehicle.

If you must drive over obstacles, drive especially slowly and carefully. If necessary, have another person direct you.

If you do not use the grab handle and the step, you could injure yourself when getting in and out of the vehicle.

In order to reduce risks:

- draw the passengers' attention to the electrical step. Wait until the electrical step is fully extended.
- do not jump out of the vehicle.
- only use the grab handle and step. Only they are designed for such a load.
- keep grab handles, access steps and entry sills free from dirt, e.g. mud, clay, snow and ice.

Operation and obstacle detection



Electrical step

The sliding door of your vehicle can be equipped with an electrical step.

- ▶ When getting in and out of the vehicle, use the grab handles and electrical step ①.

Electrical step ① automatically extends when the sliding door is opened and retracts when it is closed.

Electrical step ① is equipped with an obstruction detection device on the front side. If the step comes into contact with an obstacle while it is extending, it stops.

After you have removed the obstacle, you must first close the sliding door and open it once again so that the step can extend completely.

- i** If the electrical step obstructs loading, you can prevent the step from extending when opening the sliding door via obstacle detection. The electrical step can then remain retracted and a forklift or other lifting equipment can be moved nearer to the cargo compartment.

Vehicles without steering-wheel buttons: if the  indicator lamp in the instrument cluster lights up and a warning tone sounds, electrical step ① is malfunctioning (▷ page 203).

Vehicles with steering wheel buttons: if the **Electrical Step** message is shown in the display and a warning tone sounds, electrical step ① is malfunctioning (▷ page 192).

If electrical step ① is malfunctioning, the step may only partially extend/retract or may not extend/retract at all. If a malfunction does occur, you will have to retract and lock electrical step ① manually before continuing the journey (▷ page 67).

Before passengers get out of the vehicle, let them know that electrical step ① might not be extended.

Emergency release

- !** Driving with the step extended may result in it being damaged.

If the electrical step does not retract automatically, you will have to push it in and lock it into place manually before continuing your journey.

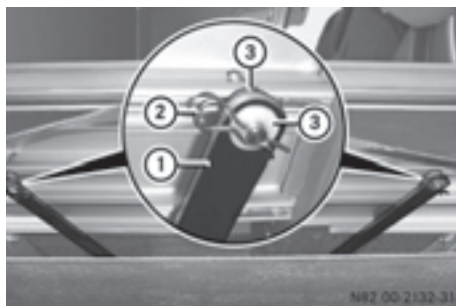

- ▶ Pull R-clips ② on both rods ① on the underside of the step out of their respective pins.
- ▶ Remove washers ③ and detach both rods ①.



- ▶ Fold rods ① into the housing in the step.
- ▶ Push the step into its housing.

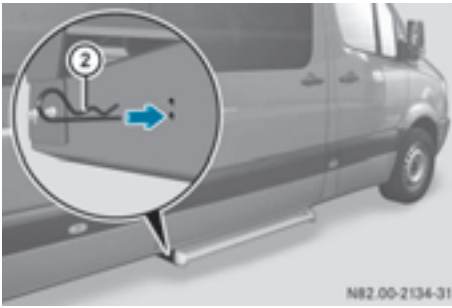

- i** When securing the step for the first time, you must pierce a film with the R-clips.
- Insert R-clips ② into the step as far as they will go through the holes on both sides of the housing. The step is secured in its housing.

Rear doors

Important safety notes

⚠ WARNING

If you open a rear door, you could:

- endanger other people or road users
- be caught by oncoming traffic

This is particularly the case if you open the rear door more than 90°. There is a risk of an accident and injury.

Only open the rear doors when traffic conditions permit. Always make sure that the rear doors are properly locked.

⚠ WARNING

If you open the rear doors to 90° (detent position), the rear lamps are no longer visible.

The vehicle is no longer sufficiently visible from the rear and will only be recognized as an obstacle at a late stage by other road users. This could lead to an accident.

Therefore, in such a situation, ensure that the vehicle is visible from the rear according to the respective national regulations, e.g. with a warning triangle.

! Make sure that there is sufficient clearance when opening the rear doors. You could otherwise damage the vehicle and objects in close range of the rear doors.

You can lock the rear doors at an angle of 90°, 180° and 270°. Always make sure that the open rear door is correctly engaged in the detent.

Opening/closing from the outside

Opening the right-hand rear door

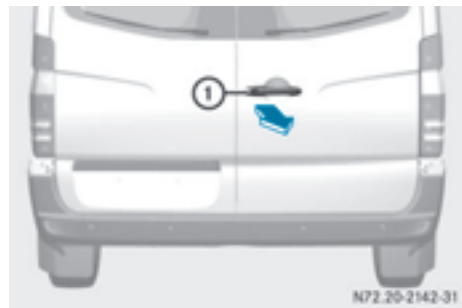

- Pull handle ①.
- Swing the rear door to the side until it engages.

Opening the left-hand rear door

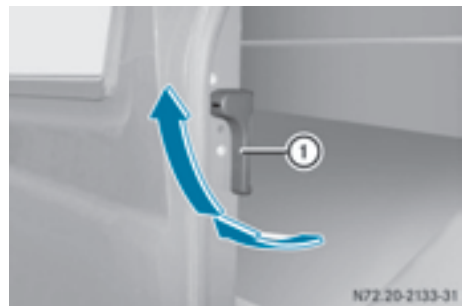

- Make sure that the right-hand rear door is open and engaged.
- Pull release handle ① in the direction of the arrow.
- Swing the rear door to the side until it engages.

Opening the rear doors to an angle of 180° or 270°

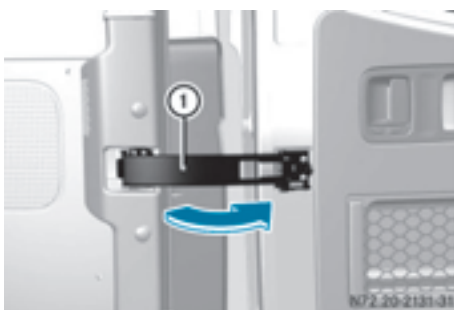

Door retainer (example: right rear door)

- ▶ Open the rear door to about 45°.
- ▶ Pull and hold door retainer ① in the direction of the arrow.
- ▶ Open the rear door more than 90°, so that the door retainer cannot engage.
- ▶ Release the door retainer and open the door to an angle of 180° or 270°.



Magnetic door retainer

- ▶ With the rear door opened to an angle of 270°, push it against magnetic door retainer ② on the side wall. When the magnet on the rear door is in contact with magnetic door retainer ②, the rear door is held in this position.
- ▶ **i** Vehicles with 270° pivoting rear doors: If door retainer ① malfunctions while loading, you can swivel it 180° against the spring force and onto the door and engage it. The door retainer remains in this position and will not swivel back to its original position. Before closing the door, release door retainer ① from the detent and return it to its original position.

Closing the rear doors from the outside

- ▶ Pull the rear door away from magnetic door retainer.
- ▶ Close the left-hand rear door firmly from the outside.
- ▶ Close the right-hand rear door firmly from the outside.

Opening/closing from the inside



Release the lever on the inside of the right rear door. A white section on latch ② indicates that the rear door is unlocked.

- ▶ **i** You can only open the locked rear doors from the inside if the child-proof locks have not been activated.
- ▶ **To unlock:** slide latch ② to the left. You will see a white marking. Only the rear door unlocks. All other doors that were previously locked remain locked.
- ▶ **To open:** pull opening lever ① and open the unlocked rear door.
- ▶ Swing the rear door to the side until it engages.
- ▶ **To close:** make sure that the left-hand rear door is closed.
- ▶ Pull the rear door firmly by the door handle to close it.
- ▶ **To lock:** slide latch ② to the right. The white section is no longer visible. Only the rear door is locked. All other doors that were previously unlocked remain unlocked.

Partition sliding door

Important safety notes

WARNING

If the open partition sliding door is not engaged, it could move automatically while the vehicle is in motion. This could trap you or other persons. There is a risk of an accident and injury.

Close the partition sliding door before every journey and make sure that it is engaged.

Opening/closing the partition sliding door from the cab



- ▶ **To open:** turn the key counter-clockwise ③. The sliding door is unlocked.
- ▶ Slide the sliding door to the stop in the direction of arrow ①.
- ▶ **To close:** slide the sliding door in the direction of arrow ① until it engages. The sliding door can be locked using the key.

Opening/closing the partition sliding door from the cargo compartment

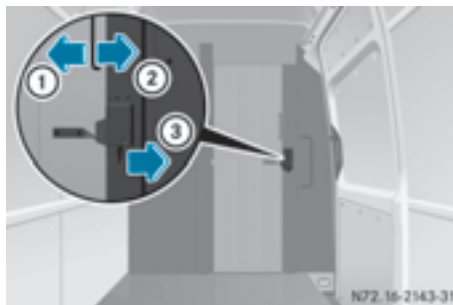

- ▶ **To unlock:** press the catch in the direction of arrow ③. The sliding door is unlocked.
- ▶ Slide the sliding door to the stop in the direction of arrow ①.
- ▶ **To close:** slide the sliding door in the direction of arrow ② until it engages.

Side windows

Important safety notes

WARNING

While opening the side windows, body parts could become trapped between the side window and the door frame as the side window moves. There is a risk of injury.

Make sure that nobody touches the side window during the opening procedure. If somebody becomes trapped, release the switch or pull the switch to close the side window again.

WARNING

While closing the side windows, body parts in the closing area could become trapped. There is a risk of injury.

When closing make sure that no parts of the body are in the closing area. If somebody becomes trapped, release the switch or press the switch to open the side window again.

⚠ WARNING

If children operate the side windows they could become trapped, particularly if they are left unsupervised. There is a risk of injury.

Activate the override feature for the rear side windows. When leaving the vehicle, always take the SmartKey with you and lock the vehicle. Never leave children unsupervised in the vehicle.

⚠ WARNING

If persons, particularly children are subjected to prolonged exposure to extreme heat or cold, there is a risk of injury, possibly even fatal. Never leave children unattended in the vehicle.

Opening/closing the side window

Control panel (example: driver's door)

- ① Power window, left
- ② Power window, right

- ▶ Turn the key to position **2** in the ignition lock.
- ▶ Press or pull button ① or ② until the corresponding side window has reached the desired position.

If you press the switch beyond the pressure point and then release it, the window opens automatically. To stop the movement, press or pull the switch again.

Resetting the side windows

You must reset the side windows if there has been a malfunction or an interruption in the voltage supply.

- ▶ Turn the key to position **2** in the ignition lock.
- ▶ Pull the two power window switches and hold for approximately 1 second after closing the side window.

Problems with the side windows

If you cannot completely open or close a side window:

If there are no objects or leaves in the window guide that prevent the sliding sunroof from closing, there has been a malfunction or the on-board voltage has been interrupted.

- ▶ Reset the side window (> page 71).

Useful information

This Operator's Manual describes all models as well as standard and optional equipment of your vehicle that were available at the time of going to print. Country-specific variations are possible. Note that your vehicle may not be equipped with all of the described functions. This also applies to systems and functions relevant to safety.

Read the information on qualified specialist workshops (▷ page 26).

Seats

Important safety notes

WARNING

You could lose control of your vehicle if you do the following while driving:

- adjust the driver's seat, head restraint, steering wheel or mirrors
- fasten the seat belt

There is a risk of an accident.

Adjust the driver's seat, head restraint, steering wheel and mirror and fasten your seat belt before starting the engine.

WARNING

If the driver's seat is not engaged, it could move unexpectedly while the vehicle is in motion. This could cause you to lose control of the vehicle. There is a risk of an accident.

Always make sure that the driver's seat is engaged before starting the engine.

WARNING

When you adjust a seat, you or other vehicle occupants could become trapped, e.g. on the seat guide rail. There is a risk of injury.

Make sure when adjusting a seat that no one has any body parts in the sweep of the seat.

WARNING

The seat belt does not offer the intended level of protection if you have not moved the back-

rest to an almost vertical position. When braking or in the event of an accident, you could slide underneath the seat belt and sustain abdomen or neck injuries, for example. This poses an increased risk of injury or even fatal injury.

Adjust the seat properly before beginning your journey. Always ensure that the backrest is in an almost vertical position and that the shoulder section of your seat belt is routed across the center of your shoulder.

WARNING

If head restraints are not installed and adjusted correctly, they cannot provide protection as intended. There is an increased risk of injury in the head and neck area, e.g. in the event of an accident or when braking.

Always drive with the head restraints installed. Before driving off, make sure for every vehicle occupant that the center of the head restraint supports the back of the head at about eye level.

Your seat must be adjusted in such a way that you can wear the seat belt correctly.

Observe the following points:

- Position the backrest in an almost vertical position so that you are sitting virtually upright. Do not drive with the backrest reclined too far back.
- Your arms should be slightly bent when you are holding the steering wheel.
- Avoid seat positions that prevent the seat belt from being routed correctly. The shoulder section of the belt must be routed over the middle of your shoulder and be pulled tight against your upper body. The lap belt must always pass across your lap as low down as possible, i.e. over your hip joints.
- Adjust the head restraint so that it supports the back of the head at eye level.
- The distance from the pedals should be such that you can depress them fully.

If you swap over the head restraints for the front and rear seats, you will not be able to adjust the height and angle of the head restraints to the correct position.

Use the head restraint pad to adjust the head restraint so that it is as close as possible to the back of your head.

Before the journey, make sure the head restraints have been correctly set for each of the vehicle's passengers (▷ page 76).

Driver's and front-passenger seat



- ① Seat fore-and-aft adjustment
- ② Lumbar support adjustment
- ③ Seat backrest adjustment
- ④ Seat height adjustment
- ⑤ Seat cushion angle adjustment
- ⑥ Seat suspension adjustment

i Depending on the seat model, some adjustments may not be available.

You can find information on rotating the front seats under "Swiveling front seats" (▷ page 73).

- ▶ **To adjust the seat fore-and-aft position:** pull lever ① up.
- ▶ Slide the seat forwards or back.
- ▶ Release lever ①.
- ▶ Slide the seat forwards or back until you hear it engage.
- ▶ **To adjust the backrest:** turn handwheel ③ towards the front.
The seat backrest moves to a vertical position.
- ▶ Turn handwheel ③ towards the rear.
The seat backrest tilts towards the rear.

- ▶ **To adjust the seat height:** press or pull lever ④ repeatedly until you have reached the desired seat height.
- ▶ **To adjust the seat angle:** turn handwheel ⑤ towards the front.
The front of the seat cushion is lowered.
- ▶ Turn handwheel ⑤ towards the rear.
The front of the seat cushion is raised.

i The lumbar support allows you to use the backrest to increase the support provided to the lumbar spine.

When the lumbar support is correctly adjusted, it reduces strain on your back while driving.

- ▶ **To adjust the lumbar support:** turn handwheel ② upwards.
This increases the support provided to the lumbar region.
- ▶ Turn handwheel ② downwards.
This reduces the support provided to the lumbar region.

The seat suspension must be adapted to your body weight. Adjust the seat suspension only while the seat is unoccupied.

- ▶ **To adjust the seat suspension:** take your weight off the seat.
- ▶ Using handwheel ⑥, set your body weight (40 to 120 kg) for optimum seat suspension. The seat suspension will become more rigid the higher you set the weight. It will then not move as far.

Swiveling front seats

⚠ WARNING

If the driver's and front-passenger seats are not engaged facing the direction of travel while driving, the restraint systems may not be able to provide the intended protection. There is an increased risk of injury, possibly even fatal.

Engage the driver's and front-passenger seats so they are facing the direction of travel before starting the engine.

- !** When rotating the seats, make sure that there is sufficient space to do so.

Move the seat forward or back first. This will help to avoid contact with other parts of the interior.

Push the handbrake lever down to the stop.

The parking brake or handbrake lever could otherwise be damaged.

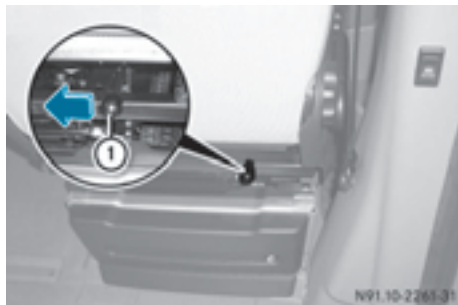

Seat release (example: front-passenger seat)

The driver's seat and front-passenger seat can be rotated by 50° and 180°.

The seats engage when facing in the direction of travel as well as when facing in the opposite direction and also engage at an angle of 50° to the door.

- ▶ Make sure that the parking brake has been engaged and that the handbrake lever has been pushed down to the stop (> page 131).
- ▶ Adjust the steering wheel to provide the necessary space to rotate and adjust the driver's seat (> page 77).
- ▶ Before rotating, push the front-passenger seat forwards (> page 73).
- ▶ **To rotate the seat:** push lever ① on the rear of the seat towards the center of the vehicle and rotate the seat slightly inwards. The rotation device is released.
- ▶ Release lever ①.
- ▶ Turn the seat about 50° towards the outside or inside to the desired position.

Twin front-passenger seat



- ▶ **To fold a seat cushion forwards:** lift the seat cushion out of front anchorage ①.
- ▶ Pull the seat cushion forwards slightly and out of rear anchorage ②.
- ▶ Fold the rear edge of the seat cushion up.
- ▶ **i** You can stow various articles in the space under the twin front-passenger seat.
- ▶ **To fold the seat cushion back:** fold down the seat cushion by the rear edge.
- ▶ Slide the seat cushion under the seat backrest into rear anchorage ②.
- ▶ Push down on the seat cushion at the front until it engages in front anchorage ①.

Folding seat

WARNING

If the key is inserted in the partition sliding door, it may come into contact with the person on the folding seat. There is a risk of injury.

Always remove the key from the partition sliding door before a person sits on the folding seat.



Folding seat (example with partition sliding door)

- ▶ Remove key ① from the partition sliding door.
- ▶ Pull grip ② of the catch in the direction of the arrow and fold seat cushion ③ up or down.
- ▶ Release grip ② of seat cushion ③ in the corresponding end position.
- ▶ Move the seat cushion ③ until it engages. Grip ② of the catch must lie completely on the seat frame.

Rear bench seat (Passenger Van)

WARNING

If the rear bench seat is not installed as described or an unsuitable rear bench seat is installed, the seat belts may not provide protection as intended. There is an increased risk of injury.

Install the rear bench seat as described. Only use rear bench seats that are approved for your vehicle by the distributor named on the inside cover page.

- !** For safety reasons, the four-seat rear bench must only be removed or installed at a qualified specialist workshop.

Keep the seat bench mounting recesses in the vehicle floor free from dirt and foreign objects.

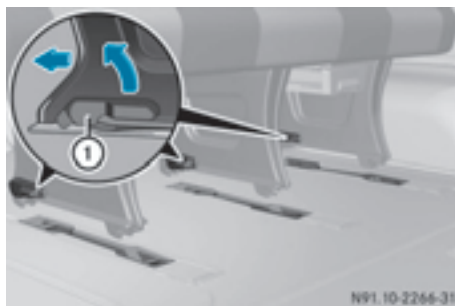

Locking mechanism lever on the feet of the bench seat

- ▶ **To remove the rear bench seat:** swing all levers ① of the bench seat completely upwards. The bench seat moves back into the seat mounting recesses on the vehicle floor.
- ▶ Lift the bench seat upwards out of the seat mounting recesses.

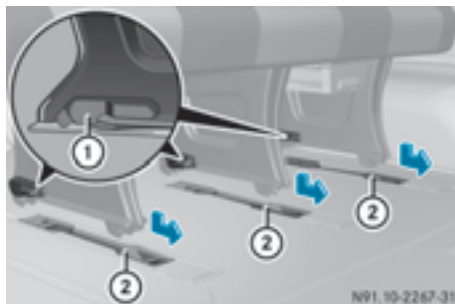

- i** Do not exceed the maximum permissible number of seats for models registered as passenger vehicles.
- ▶ **To install the rear bench seat:** observe the prescribed installation position of the bench seat. Install the two-seat bench seat only on the driver's side.
- ▶ Check mounting shells ② on the vehicle floor.
- ▶ Position the bench seat in the direction of travel in corresponding mounting shells ②.
- ▶ Slide the bench seat forwards until you hear the locking mechanisms engage.
- ▶ Check levers ① on the anchorages of the bench seat. All levers ① must be flush to the vehicle floor.

Head restraints

⚠ WARNING

If head restraints are not installed and adjusted correctly, they cannot provide protection as intended. There is an increased risk of injury in the head and neck area, e.g. in the event of an accident or when braking.

Always drive with the head restraints installed. Before driving off, make sure for every vehicle occupant that the center of the head restraint supports the back of the head at about eye level.

Do not change over the head restraints for the front and rear seats. Otherwise, it will not be possible to correctly adjust the height and angle of the head restraints.

Adjust the head restraint so that it is as close as possible to your head.

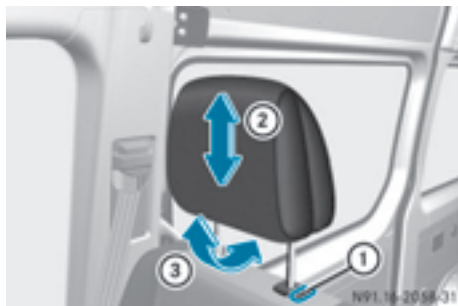

Head restraint (example: luxury head restraint on the front-passenger seat)

- ① Release button
 - ② Head restraint height
 - ③ Head restraint angle (luxury head restraints only)
- ▶ **To raise:** pull the head restraint up to the desired position.
 - ▶ **To lower:** press release button ① and slide the head restraint down to the desired position.
 - ▶ **To adjust the angle:** hold the front part of the luxury head restraint by the lower edge and tilt it to the desired position.
 - ▶ **To remove:** pull the head restraint up to the stop.
 - ▶ Press release button ① and pull out the head restraint.

- ▶ **To insert:** insert the head restraint so that the rod with the detents is on the left when viewed in the direction of travel.
- ▶ Press and hold release button ①.
- ▶ Push the head restraint down until it engages.

Armrests

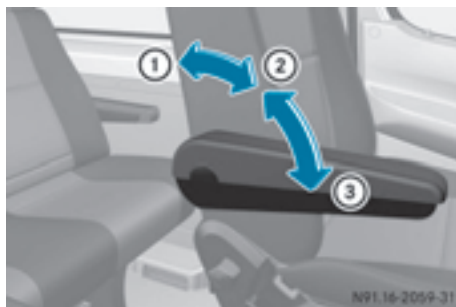

- ▶ **To set the armrest angle:** fold the armrest upwards by more than 45° ②. The armrest is released.
- ▶ Fold armrest ③ forwards to the stop.
- ▶ Slowly fold the armrest upwards to the desired position.
- ▶ **To fold the armrest up:** if necessary, fold the armrest upwards ① by more than 90°.

Seat heating

⚠ WARNING

Repeatedly switching on the seat heating can cause the seat cushion and backrest pads to become very hot. The health of persons with limited temperature sensitivity or a limited ability to react to excessively high temperatures may be affected or they may even suffer burn-like injuries. There is a risk of injury. Therefore, do not switch the seat heating on repeatedly.

- ⚠ When you leave your seat, do not place anything on the seat and switch off the seat heating. Do not switch the seat heating on when the seat is not occupied, e.g. when driving without a front passenger. The seat heating may otherwise overheat, causing damage to the seat.





The three red indicator lamps in the  button show the activated heating level 1 to 3.

The system automatically switches down from level 3 to level 2 after approximately five minutes.

The system automatically switches down from level 2 to level 1 after approximately ten minutes.

At level 1, the seat heating remains in continuous operation.

- ▶ Make sure that the key is in position 1 or 2 in the ignition lock.
- ▶ **To switch on:** press the  button repeatedly until the desired heating level has been set.
- ▶ **To switch off:** press the  button repeatedly until all indicator lamps go out.

If the indicator lamps of the current heating level in the  button flash, the seat heating has switched off automatically. In this case, too many electrical consumers are switched on or the battery charge is not sufficient. The seat heating will automatically switch back to the current heating level when enough on-board voltage is available again.

Steering wheel

WARNING

You could lose control of your vehicle if you do the following while driving:

- adjust the driver's seat, head restraint, steering wheel or mirrors
- fasten the seat belt

There is a risk of an accident.

Adjust the driver's seat, head restraint, steering wheel and mirror and fasten your seat belt before starting the engine.

WARNING

If the steering wheel is unlocked while the vehicle is in motion, it could change position unexpectedly. This could cause you to lose control of the vehicle. There is a risk of an accident.

Before starting off, make sure the steering wheel is locked. Never unlock the steering wheel while the vehicle is in motion.

WARNING

Children could injure themselves if they adjust the steering wheel. There is a risk of injury.

When leaving the vehicle, always take the SmartKey with you and lock the vehicle. Never leave children unsupervised in the vehicle.

The steering wheel can still be adjusted if the key has been removed.

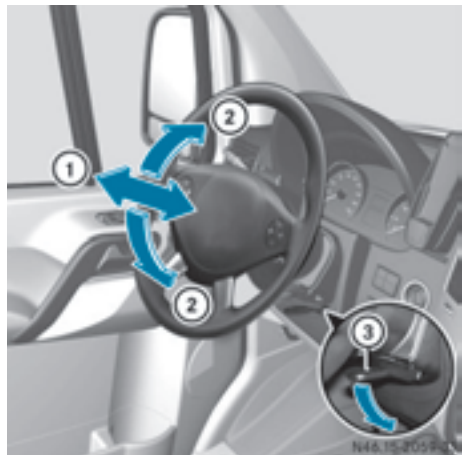

- ① Steering column fore-and-aft adjustment
- ② Steering column height
- ③ Lever

- ▶ **To set the steering wheel:** swing lever ③ down until it engages.
The steering wheel is unlocked.
- ▶ Move the steering wheel to the desired position.
- ▶ Pull lever ③ up to the stop.
The steering wheel is locked again.

Mirrors

Rear-view mirror



- ▶ **Anti-glare mode:** push anti-glare lever ① in the direction of the arrow.

Exterior mirrors

Important safety notes

WARNING

The additional mirrors in the exterior mirrors reduce the size of the image. Objects visible in the mirrors are closer than they appear. You could misjudge the distance from road users driving behind you when changing lanes, for instance. There is a risk of an accident.

You should therefore always determine the actual distance from road users driving behind you, e.g.:

- by looking over your shoulder
- by looking in the main mirror in the exterior mirror.

Adjusting manually

- ▶ Before starting off, manually adjust the exterior mirrors in such a way that you can get a good overview of road and traffic conditions.

Adjusting electrically

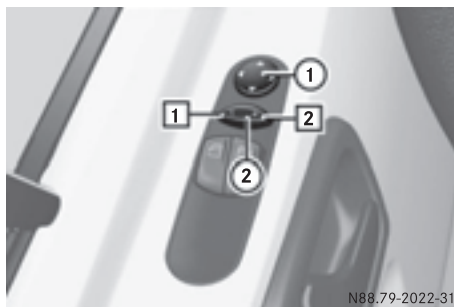

Adjustment buttons and switches for setting the mirrors

- ▶ Before pulling away, turn the key to position 2 in the ignition lock (▶ page 119).
- ▶ Press switch ② to position 1 for the left-hand exterior mirror or to position 2 for the right-hand exterior mirror.
- ▶ Press adjustment button ① at the top, bottom, right or left.

Adjust the exterior mirrors in such a way that you can get a good overview of road and traffic conditions.

- i** The exterior mirrors are automatically heated at low outside temperatures.

Useful information

This Operator's Manual describes all models as well as standard and optional equipment of your vehicle that were available at the time of going to print. Country-specific variations are possible. Note that your vehicle may not be equipped with all of the described functions. This also applies to systems and functions relevant to safety.

Read the information on qualified specialist workshops (▷ page 26).

Exterior lighting

Important safety notes

For reasons of safety, we recommend that you drive with the lights switched on even during the daytime. There may be differences in operation due to legal requirements and voluntary recommendations in some countries.

Bulb failure indicator

The bulb failure indicator is only an aid. You are responsible for the proper functioning of the vehicle lighting. Insufficient or non-functioning vehicle lighting puts the operating safety of the vehicle at risk.

For this reason, check the condition and function of your vehicle's lighting system and, if necessary, that of the trailer before each journey.





The bulb failure indicator monitors all of the exterior lighting lamps, except the perimeter lamp and the trailer lighting. If a bulb fails, either the  (▷ page 33) indicator lamp lights up, or you will see a corresponding message in the display (▷ page 185).

- i** Depending on the equipment, the bulb failure indicator can fail for all lamps with the exception of the turn signal lamps.

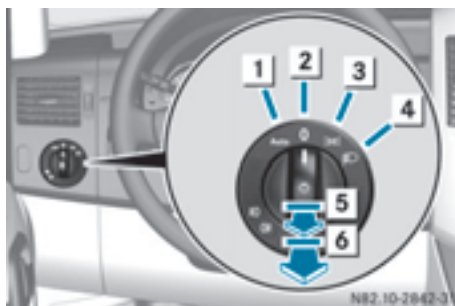
Light switch

Operation





- | | | |
|----------|---|--|
| 1 |  AUTO | Automatic headlamp mode/daytime running lamps |
| 2 | 0 | Lights off |
| 3 |  | Parking lamps, license plate and instrument lighting |
| 4 |  | Low-beam/high-beam headlamps |
| 5 |  | Fog lamps |
| 6 |  | Rear fog lamp |

If you hear a warning tone when you leave the vehicle, the lights may still be switched on.

- ▶ Turn the light switch to **0** or **AUTO**.
- or
- ▶ If the rear fog lamp is switched on: press the light switch in to the stop.

The turn signals, high-beam headlamps and the high-beam flasher are operated using the combination switch (▷ page 81).

Low-beam headlamps

- ▶ **To switch on:** turn the key to position **2** in the ignition lock or start the engine.
- ▶ Turn the light switch to position . The  indicator lamp in the instrument cluster lights up.

Daytime running lamps

You can activate/deactivate the daytime running lamps function using the on-board computer.

This is not possible in countries where daytime running lamps are a legal requirement.



The daytime running lamps function must be activated using the on-board computer:

- vehicles with steering wheel buttons (▷ page 171)
- vehicles without steering wheel buttons (▷ page 164)



► **To switch on:** turn the light switch to the  position.

The low-beam headlights, parking lamps and license plate lamp are switched on when the engine is running. The  indicator lamp in the instrument cluster lights up.

i USA only:

If you turn the light switch to the  or  position, the parking lamps or low-beam headlights switch on. If you turn the light switch to the **AUTO** position, the daytime running lamps remain switched on.

i Canada only:

If you turn the light switch to the  position, the low-beam headlights are switched on. If you turn the light switch to the  or **AUTO** position, the daytime running lamps remain switched on.

Automatic headlamp mode

WARNING

When the light switch is set to **AUTO**, the low-beam headlights may not be switched on automatically if there is fog, snow or other causes of poor visibility due to the weather conditions such as spray. There is a risk of an accident.

In such situations, turn the light switch to



Automatic headlamp mode is only a driving aid. You are responsible for the vehicle lighting at all times.

Depending on ambient light, the rain and light sensor automatically switches on the parking lamps, low-beam headlights and the license plate lamp. This excludes weather-related impairments to visibility, such as snow, fog or spray.

If there is fog, snow or spray, turn the light switch quickly from **AUTO** to . You could otherwise briefly interrupt operation of the headlights.

► **To switch on automatic headlamp mode:** turn the light switch to **AUTO**.

Key in position **1** in the ignition lock: the parking lamps switch on or off automatically depending on the ambient light.

When the engine is running: if you activate the "daytime running lamps" function using the on-board computer, the daytime running lamps are switched on. The parking lamps and low-beam headlights also switch on or off automatically, depending on the ambient light.

When the low-beam headlights are switched on, the  indicator lamp in the instrument cluster lights up.

Fog lamps/rear fog lamp

WARNING

If you suspect that driving conditions will be foggy, turn the light switch to  before you start your journey. Your vehicle may otherwise not be visible and you could endanger yourself and others.

WARNING

In low ambient lighting or foggy conditions, only switch from position **AUTO** to  with the vehicle at a standstill in a safe location.

Switching from **AUTO** to  will briefly switch off the headlights. Doing so while driving in low ambient lighting conditions may result in an accident.



► Turn the ignition key to position **2** in the ignition lock or start the engine.

► Turn the light switch to  or .

i If your vehicle is only equipped with one rear fog lamp, you must turn the light switch to .

i When the light switch is set to **AUTO** you cannot switch on the front and rear foglamps.

► **To switch on the front fog lamps:** pull the light switch out to the first locking point. The green  indicator lamp on the light switch lights up.

- ▶ **To switch on the rear fog lamp:** pull the light switch out to the second locking point. The yellow  indicator lamp on the light switch lights up.
- ▶ **To switch off the front and rear foglamps:** push in the light switch to the stop. The  and  indicator lamp on the light switch go out.

Combination switch

Turn signal lamps

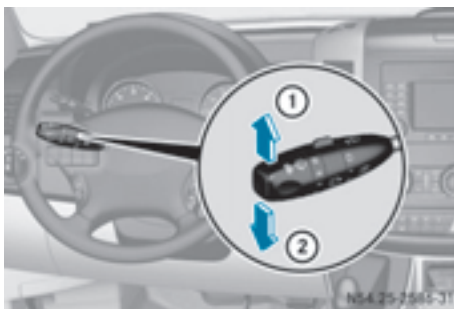



- ① To indicate a right turn
- ② To indicate a left turn

- ▶ **To indicate:** press the combination switch in desired direction ① or ② until it engages. The combination switch automatically returns to its original position after large steering movements.
- ▶ **To indicate briefly:** press the combination switch briefly in desired direction ① or ②. The corresponding turn signal flashes three times.

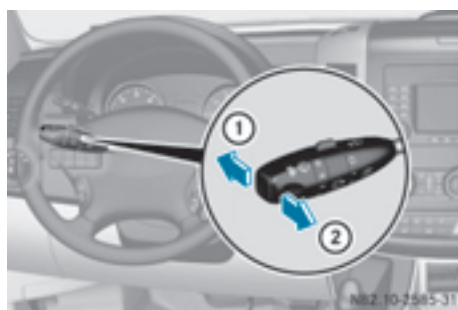
High-beam headlamps and high-beam flasher



- ① High-beam headlamps
- ② High-beam flasher

- ▶ **To switch on the high-beam headlamps:** switch on the low-beam headlamps (> page 79).
- ▶ Press combination switch ① forwards. The  indicator lamp in the instrument cluster lights up.
 - ⓘ In the **AUTO** position, the high-beam headlamps are only switched on when it is dark and the engine is running.
- ▶ **To switch off the high-beam headlamps:** move the combination switch back to its normal position. The  indicator lamp in the instrument cluster goes out.
- ▶ **To switch on the high-beam flasher:** turn the key to position 1 or 2 in the ignition lock.
- ▶ Pull the combination switch briefly in direction of arrow ②.

Headlamp range adjustment



The headlamp range control is used to adapt the downward angle of the headlamp beams in accordance with the load on your vehicle. The cone of light from the headlamps changes if seats are occupied or if the cargo compartment is being loaded or unloaded. This can impair visibility and cause glare to oncoming traffic.

You can only adjust the headlamp range while the engine is running.

- ▶ Turn headlamp range control ① to the corresponding position. The road ahead should be lit up for 40 m to 100 m and the low-beam headlamps should not cause glare to oncoming traffic.

Select position **0** if the vehicle is unladen.

Cornering lamps

The cornering lamps improve the illumination of the road over a wide angle in the direction you are turning, enabling better visibility in tight bends, for example.

The cornering light function switches on automatically, if:

- you are traveling at a speed of less than 25 mph (40 km/h) and you switch on a turn signal or turn the steering wheel.
- you are traveling at speeds of between 25 mph (40 km/h) and 43 mph (70 km/h) and turn the steering wheel.

The cornering lamp may remain lit for a short time, but is automatically switched off after no more than 3 minutes.

- ❗ If reverse gear is engaged the lamp on the opposite side of the vehicle switches on instead.

Hazard warning lamps

⚠ WARNING

The rear exterior light will be covered if you:

- open the rear doors by 90°
- open the rear dropside.

The vehicle will then be difficult for other road users to see or will not be seen by them at all, particularly if it is dark or visibility is poor.

There is a risk of an accident.

You should therefore ensure in this and similar situations that the vehicle is visible from the rear in accordance with the relevant national regulations, by using the warning triangle, for instance.



Hazard warning lamp switch

- ▶ **To switch on/off:** press the  hazard warning lamp switch.

If you have indicated a turn while the hazard warning lamps are switched on, only the turn signal lamps on the side of the vehicle selected will light up.

The hazard warning lamps switch on automatically if:

- an air bag is deployed.
- you brake sharply and bring the vehicle to a halt from a speed of more than 45 mph (70 km/h).

If the hazard warning lamps have been switched on automatically, press the  hazard warning lamp switch to switch them off.

- ❗ The hazard warning lamps work even when the ignition is switched off.

Headlamp cleaning system

The headlamps are cleaned automatically with a high-pressure water jet if the "Wipe with washer fluid" function is activated (> page 93) while the low-beam headlamps are on and the engine is running.

You can find information on refilling washer fluid in the "Maintenance and care" section (> page 224).

Highbeam Assist

General notes

You can use this function to set the headlamps to change between low beam and high beam automatically. The system recognizes vehicles with their lights on, either approaching from the opposite direction or traveling in front of your vehicle, and consequently switches the headlamps from high beam to low beam.

Once the system no longer detects any other vehicles, it reactivates the high-beam headlamps.

The system's optical sensor is located behind the windshield near the overhead control panel.

Important safety notes

WARNING

Highbeam Assist does not recognize road users:

- who have no lights, e.g. pedestrians
- who have poor lighting, e.g. cyclists
- whose lighting is blocked, e.g. by a barrier

In very rare cases, Highbeam Assist may fail to recognize other road users who have lights, or may recognize them too late. In this or similar situations, the automatic high-beam headlamps will not be deactivated or will be activated regardless. There is a risk of an accident.

Always carefully observe the traffic conditions and switch off the high-beam headlamps in good time.

Highbeam Assist cannot take into account road, weather or traffic conditions. Highbeam Assist is only an aid. You are responsible for adjusting the vehicle's lighting to the prevailing light, visibility and traffic conditions.

In particular, the detection of obstacles can be restricted if there is:

- poor visibility, e.g. due to fog, heavy rain or snow
- dirt on the sensors or anything else covering the sensors

Activating/deactivating Highbeam Assist



- ▶ **To activate:** switch on the Highbeam Assist function using the on-board computer (▷ page 171).
- ▶ Turn the light switch to the **AUTO** position.
- ▶ Press the combination switch beyond the pressure point in the direction of arrow ① (▷ page 81).
Highbeam Assist is active.

The  or  indicator lamp in the multifunction display lights up when it is dark and the light sensor activates the low-beam headlamps.

If you are driving at speeds above approximately 22 mph (35 km/h) and no other road users have been detected:

The high-beam headlamps are switched on automatically. The  indicator lamp in the instrument cluster also lights up.

If you are driving at speeds below approximately 19 mph (30 km/h), other road users are recognized or the roads are adequately lit:

The high-beam headlamps are switched off automatically. The  indicator lamp in the instrument cluster goes out. The  or  indicator lamp in the multifunction display remains lit.

- ▶ **To deactivate:** move the combination switch back to its normal position or move the light switch to another position.

The  or  indicator lamp in the multifunction display goes out.

Headlamps fogged up on the inside

The headlamps may fog up on the inside if there is high atmospheric humidity.

- ▶ Switch on the low-beam headlamps and drive off.

The level of moisture diminishes, depending on the length of the journey and the weather conditions (humidity and temperature).

If the level of moisture does not diminish:

- ▶ Have the headlamps checked at a qualified specialist workshop.

Interior lighting

Switching the dashboard lighting on/off

Overview



Standard interior light

- 1 Interior light switched on
- 2 Interior light switched off
- 3 Automatic control system switched on



Interior lights in the overhead control panel

- 1 Switches the left-hand reading lamp on/off
- 2 Switches the right-hand reading lamp on/off
- 3 Right-hand reading lamp
- 4 Interior light
- 5 Switches the automatic control system on/off
- 6 Switches the interior light on/off
- 7 Left-hand reading lamp

If you manually switch on the interior lighting or reading lamps on the overhead control panel, they switch off automatically after 20 minutes.

Automatic control

The interior light comes on if you:

- unlock the vehicle
- open the driver's or the front-passenger door
- remove the key from the ignition lock

The interior light switches off again automatically.

If a door is left open, the interior lighting switches off after approximately 20 minutes.

Switching the rear compartment lighting on/off centrally (Passenger Van)



Rear compartment lighting switch

- 1 To switch on the rear compartment lighting
- 2 Automatic control
- 3 To switch off the rear compartment lighting

You can switch the rear compartment lighting on/off centrally on Passenger Vans that are equipped with convenience control.

There may also be a switch on the rear compartment lights that allows you to switch them on/off separately. If you switch off rear compartment lighting ③, the rear compartment light is switched off, regardless of the position of its own switch.

If you move the rear compartment lighting switch to center position ②, the automatic control system is switched on. When you open a door or unlock the vehicle, the rear compartment lighting then goes on automatically. Once the doors are closed, it switches off automatically after 20 minutes.

Switching the rear/cargo compartment lamp on/off

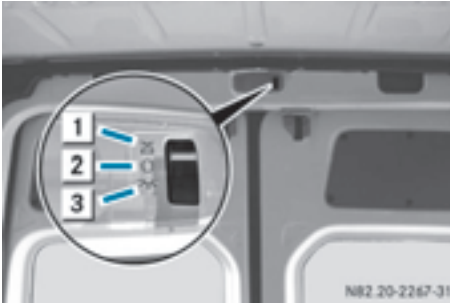

Interior light with switch (example: Cargo Van)

- 1 Automatic control
- 2 To switch off the interior lighting
- 3 To switch on the interior lighting



Interior light with switch (example: Passenger Van with rear-compartment air conditioning)

- 1 To switch on the interior lighting
- 2 To switch off the interior lighting
- 3 Automatic control

For Cargo Vans and Passenger Vans without convenience control, the switch for the interior lighting is on the rear interior light in the cargo compartment/vehicle interior.

If you move the switch to automatic control, the rear/cargo compartment lamps go on when you open a door or unlock the vehicle. They switch off automatically after 20 minutes, or when you close the doors.

Motion detector

WARNING

The motion detector sends the invisible infrared radiation emitted by LEDs (light emitting diodes).

These LEDs are classified as class 1M lasers and can damage the retina if you:

- look directly into the unfiltered laser beam of the motion detector for an extended period
- look directly into the laser beam of the motion detector using optical instruments, e.g. eyeglasses or a magnifying glass.

There is a risk of injury.

Never look directly into the motion detector.

The load compartment lighting is also switched on by the motion detector in the load compartment on panel vans equipped with this feature. If the motion detector detects a movement in the cargo compartment when the vehicle is stationary, the cargo compartment lighting switches on for approximately two minutes. The cargo compartment lighting can be switched on by the motion detector within four seconds if:

- the rear interior light switch (> page 84) is set to automatic control.
- the vehicle is stationary, the parking brake is applied and the brake pedal is not being depressed
or
- the selector lever is in position **P** on vehicles with automatic transmission and the brake pedal is not being depressed and
- the vehicle has not been locked from the outside using the key

The motion detector switches off automatically if no change is detected in the vehicle for several hours, e.g. if a door is opened, if the ignition key is turned, etc. This prevents the battery from becoming discharged.

Changing bulbs

Important safety notes

DANGER

Xenon bulbs carry a high voltage. You can get an electric shock if you remove the cover of the Xenon bulb and touch the electrical contacts. There is a risk of fatal injury.

Never touch the parts or the electrical contacts of the Xenon bulb. Always have work on the Xenon bulbs carried out at a qualified specialist workshop.

WARNING

Bulbs, lamps and connectors can get very hot when operating. If you change a bulb, you could burn yourself on these components. There is a risk of injury.

Allow these components to cool down before changing a bulb.

- ❗ Make sure the bulbs are always securely installed.

If your vehicle is equipped with Bi-Xenon bulbs, you can recognize this by the following: the cone of light from the Xenon bulbs moves from the top to the bottom and back again when you start the engine. For this to be observed, the low-beam headlamps must be switched on before starting the engine.

The bulbs and lamps are an essential component of vehicle safety. You must therefore make sure that these function correctly at all times. Have the headlamp setting checked regularly.

- Always switch off the vehicle's lighting system before changing a bulb. This will prevent a short circuit.
- Do not touch the glass tube of new bulbs with your bare hands. Always use a clean, lint-free cloth or only touch the base of the bulb when installing. Even minor contamination can burn into the glass surface and reduce the service life of the bulbs.
- Do not use a bulb that has been dropped or that has scratches on its glass tube. The bulb could explode.
- Only use bulbs in closed lamps which have been designed for this purpose.

- Only use spare bulbs of the same type and with the prescribed voltage
 - Protect the bulbs from moisture when in use.
- If the new bulb still does not light up, consult a qualified specialist workshop.

- Have the LEDs and bulbs of the following lamps changed at a qualified specialist workshop:
 - the additional turn signals in the exterior mirrors
 - the high-mounted brake lamp
 - LED daytime running lamps (Bi-Xenon headlamps)
 - Bi-Xenon lamps (Bi-Xenon headlamps)
 - front fog lamps

If you require assistance changing bulbs, consult a qualified specialist workshop.

Front bulbs

Overview of bulb replacement – bulb types

The following bulbs can be replaced. Bulb types can be found in the legend.

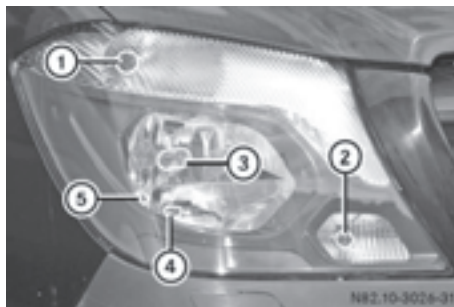

Vehicles with halogen headlamps

- ① Turn signal: PY2 1W
- ② Daytime running lamps: W2 1W
- ③ Low-beam headlamps: H7 55W
- ④ High-beam headlamps: H7 55W
- ⑤ Parking lamps/standing lamps: W5W

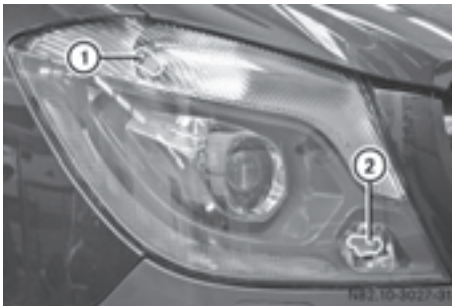

Vehicles with bi-xenon headlamps

- ① Turn-signal: NAK 3457
- ② Cornering light function: H7 55W

Vehicles with additional turn signals in the exterior mirrors

Additional turn signal lamp: HPC 16WY

Low-beam headlamps and high-beam headlamps/cornering lamp

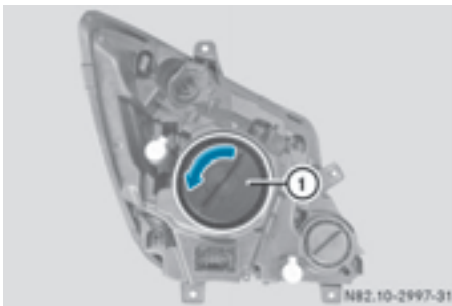

Example (halogen headlamps)

- ▶ Switch off the lighting system.
- ▶ Open the hood (▷ page 218).
- ▶ Turn housing cover ① in the direction of the arrow and remove it.

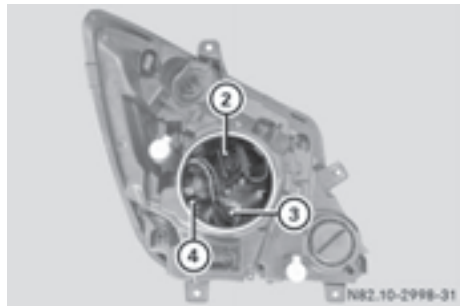

Example (halogen headlamps)

- ② Low-beam headlamp bulb holder
- ③ Bulb holder for high-beam headlamp
- ④ Bulb holder for parking lamp/standing lamp (halogen headlamps)

- ▶ Turn the corresponding bulb holder with bulb ②, ③ or ④ counter-clockwise and pull it out of the lamp.
- ▶ Pull the bulb out of the bulb holder.
- ▶ Insert the new bulb in such a way that its base fits into the recess of the bulb holder.
- ▶ Insert the bulb holder with the bulb into the lamp and turn it clockwise to tighten. The bulb holder engages audibly.
- ▶ Place housing cover ① into the opening and turn in the opposite direction of the arrow.
- ▶ Close the hood.

Cornering light function/daytime running lamps

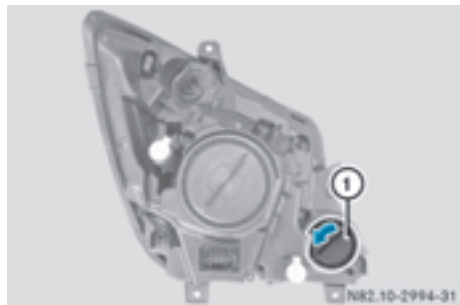

- ▶ Switch off the lighting system.
- ▶ Open the hood (▷ page 218).
- ▶ Turn housing cover ① counter-clockwise and remove.

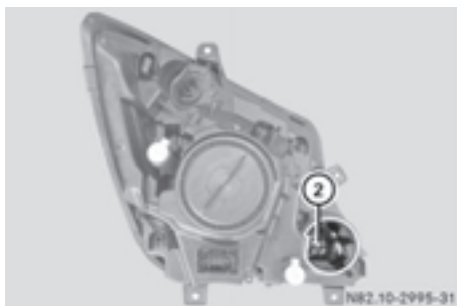

► **Bi-Xenon headlamps:** turn bulb holder with bulb ② counter-clockwise and remove it.

Halogen headlamps: press the spring catches of the bulb holder together and remove the bulb holder with bulb ②.

- Pull the bulb out of the bulb holder.
- Press a new bulb into the bulb holder.
- **Bi-Xenon headlamps:** insert the bulb holder with bulb ② into the lamp and turn clockwise.

Halogen headlamps: insert the bulb holder with bulb ② into the lamp.

The bulb holder with bulb ② engages audibly.

- Replace cap ① and turn it clockwise to the stop.
- The cap audibly engages.
- Close the hood (▷ page 219).

Turn signal lamps

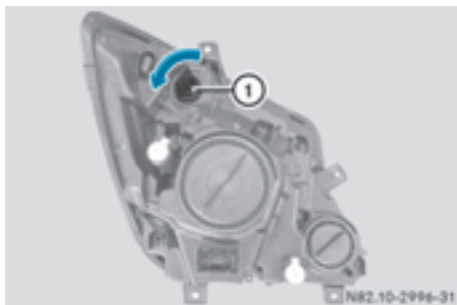

- Switch off the lighting system.
- Open the hood (▷ page 218).
- Turn bulb holder ① counter-clockwise and remove it.
- Applying light pressure to the bulb, turn it counter-clockwise and remove it from bulb holder ①.

- Press the new bulb into bulb holder ① and screw it in clockwise.
- Insert bulb holder ① into the lamp and turn it clockwise to tighten.
- Close the hood.

Additional turn signal lamp (all-wheel-drive vehicles)

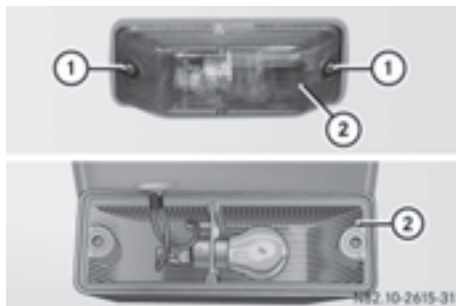

Additional turn signals (example: Cargo Van and Passenger Van)

The additional turn signals are mounted on the side of the vehicle's front wings.

- Switch off the lighting system.
- Undo screws ① and remove lamp lens ②.
- Applying light pressure to the bulb, turn it counter-clockwise and remove it from the bulb holder.
- Press the new bulb into the bulb holder and screw it in clockwise.
- Position lamp lens ② and tighten screws ①.

Rear bulbs (Cargo Van/Passenger Van)

Overview of bulb types

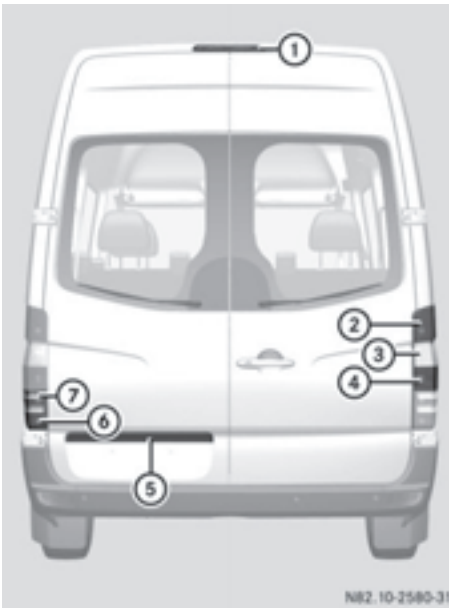

	Lights	Bulb type
①	High-mounted brake lamp	LED
②	Brake lamp/tail lamp	P21W/5W
③	Turn signal lamps	PY 21 W
④	Tail lamps/standing lamps	R5W
⑤	License plate lamp	W5W
⑥	Rear fog lamps (driver's side)	P21W
⑦	Backup lamps	P21W

Tail lamps

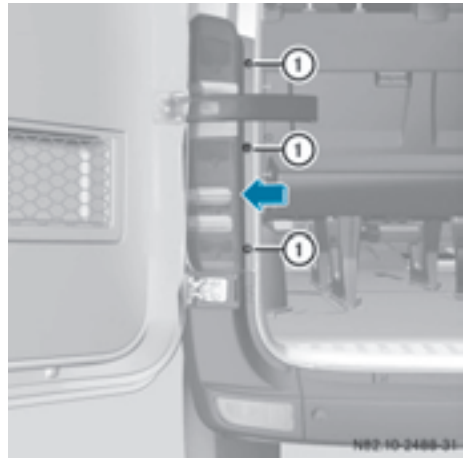

- ▶ Switch off the lighting system.
- ▶ Open the rear door.
- ▶ Undo screws ① and unclip the lamp lens in the direction of the arrow.
- ▶ Pull the connector off the bulb holder.

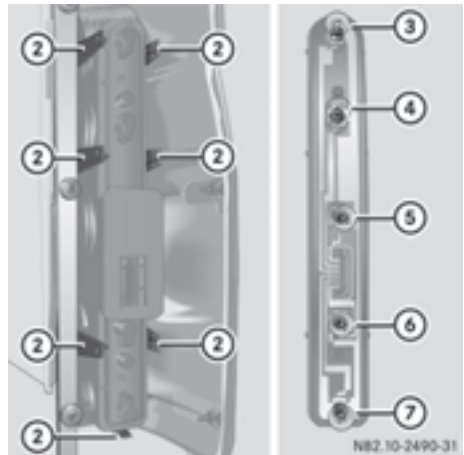

- ② Retaining lugs
- ③ Brake lamps
- ④ Turn signal lamps
- ⑤ Standing lamp/tail lamp
- ⑥ Backup lamps
- ⑦ Rear fog lamp

- ▶ Release retaining lugs ② and take the bulb holder out of the tail lamp.
- ▶ Applying light pressure to the bulb, turn it counter-clockwise and remove it from the bulb holder.
- ▶ Press the new bulb into the bulb holder and screw it in clockwise.
- ▶ Press the connector into the bulb holder.
- ▶ Insert the lamp lens.
 - To do this, clip the bulb holder into the three holes provided at the side and tighten screws ①.

License plate lamp

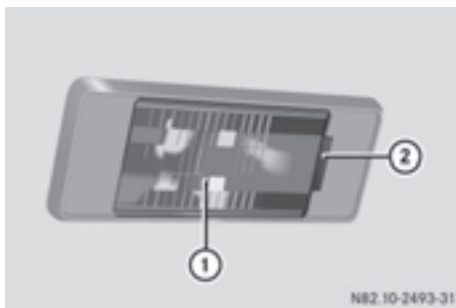

- ▶ Switch off the lighting system.
- ▶ Insert a screwdriver or similar implement into recess ② and carefully pry off lamp lens ①.
- ▶ Pull the bulb out of the bulb holder.
- ▶ Insert a new bulb.
- ▶ Align lamp lens ① and clip it in so that it engages.

Rear bulbs (Cab Chassis)

Overview of bulb types

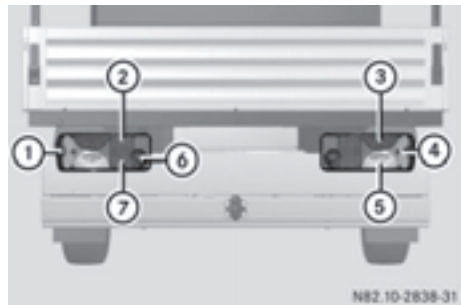

Chassis (example: Cab Chassis)

	Lights	Bulb type
①	Perimeter lamp/standing lamp	R 5 W
②	Tail lamps	R 5 W
③	Brake lamps	P 21 W
④	Turn signal lamps	PY 21 W
⑤	Backup lamps	P 21 W
⑥	Rear fog lamps (driver's side)	P 21 W
⑦	License plate lamp	R 5 W

Tail lamps

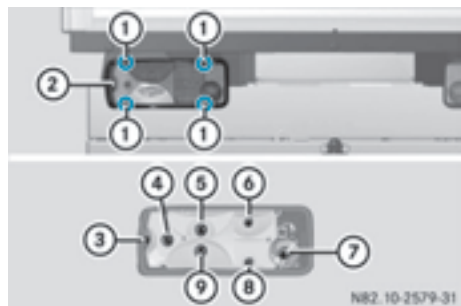

- ① Screws
- ② Lamp lens
- ③ Perimeter lamp/standing lamp
- ④ Turn signal lamps
- ⑤ Brake lamps
- ⑥ Tail lamps

- ⑦ Rear fog lamp
- ⑧ License plate lamp
- ⑨ Backup lamps
- ▶ Switch off the lighting system.
- ▶ Undo screws ① and remove lamp lens ②.
- ▶ Applying light pressure to the bulb, turn it counter-clockwise and remove it from the bulb holder.
- ▶ Press the new bulb into the bulb holder and screw it in clockwise.
- ▶ Position lamp lens ② and tighten screws ①.

Additional lamps

Additional turn signal lamp on the roof

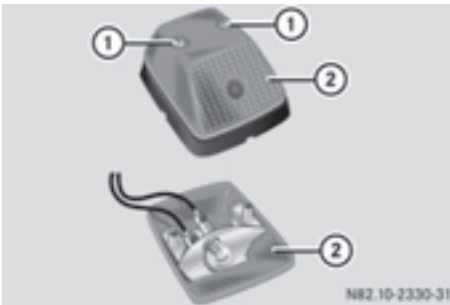

Type of lamp: P 21 W

- ▶ Switch off the lighting system.
- ▶ Undo screws ① and remove lamp lens ②.
- ▶ Applying light pressure to the bulb, turn it counter-clockwise and remove it from the bulb holder.
- ▶ Press the new bulb into the bulb holder and screw it in clockwise.
- ▶ Position lamp lens ② and tighten screws ① again.

Perimeter lamp (Cab Chassis)

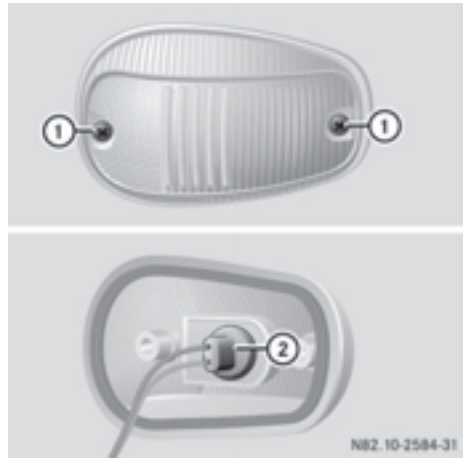

Type of lamp: W 5 W

- ▶ Switch off the lighting system.
- ▶ Undo screws ① and remove the lamp unit.
- ▶ Turn bulb holder ② and remove it.
- ▶ Remove the bulb from bulb holder ②.
- ▶ Press the new bulb into bulb holder ②.
- ▶ Screw bulb holder ② into the lamp unit.
- ▶ Carefully position the lamp housing and tighten screws ①.

Courtesy lights, rear compartment

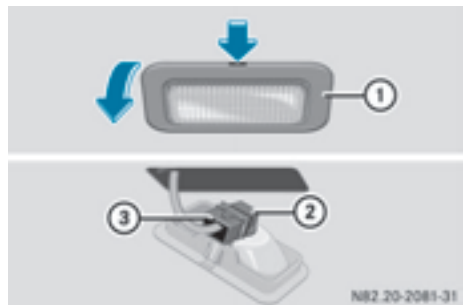

Bulb type: W5W

- ▶ Press in the latching spring of courtesy light ① with a suitable implement, e.g. a screwdriver.
- ▶ Pry off courtesy light ①.
- ▶ Disconnect cable connector ③.
- ▶ Unscrew bulb holder ②.

- ▶ Remove the bulb from bulb holder ②.
- ▶ Press the new bulb into bulb holder ②.
- ▶ Screw bulb holder ② into courtesy light ①.
- ▶ Connect cable connector ③.
- ▶ The connector locking spring must engage.
- ▶ Align courtesy light ① on the side and engage.

Interior lighting

General notes

- ! Have the bulbs in the overhead control panel replaced at a qualified specialist workshop. You could otherwise damage the overhead control panel.

Front interior light

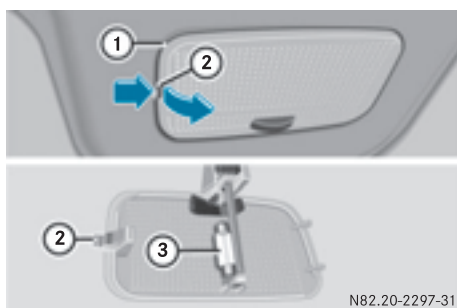

Type of lamp: K 18 W

- ▶ Switch off the interior lighting.
- ▶ Press spring catch ② in the direction of the arrow and lift off interior light ①.
- ▶ Remove bulb ③ from the bulb holder.
- ▶ Insert new bulb ③.
- ▶ Align interior light ① on the right-hand side and engage the spring catch.

Rear interior light

Interior light with switch

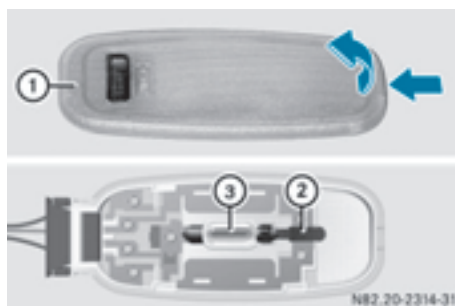

Interior light with switch

Type of lamp: K 15 W

- ▶ Switch off the interior lighting.
- ▶ Press in the catch springs of lamp housing ① with a suitable object and pry off lamp housing ①.
- ▶ Press the contact spring of bulb holder ② outwards and remove bulb ③.
- ▶ Insert a new bulb ③.
- ▶ Align lamp housing ① on the left-hand side and engage.

- ! **Vehicles with LED lighting:** if an LED is faulty, consult a qualified specialist workshop.

Interior light without switch

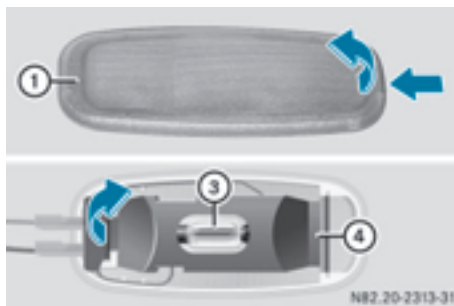

Interior light without switch

Type of lamp: K 15 W

- ▶ Switch off the interior lighting.
- ▶ Press in the catch springs of lamp housing ① with a suitable object and pry off lamp housing ①.
- ▶ Open protective cover ④.
- ▶ Press the contact spring of bulb holder ② outwards and remove bulb ③.
- ▶ Insert new bulb ③.

- ▶ Fold protective cover ④ back into place.
- ▶ Align lamp housing ① on the left-hand side and engage.

i Vehicles with LED lighting: if an LED is faulty, consult a qualified specialist workshop.

Cargo compartment lamp



Type of lamp: W 10 W

- ▶ Switch off the interior lighting.
- ▶ Undo screws ① and remove the lamp lens.
- ▶ Press bulb ② into the bulb holder and unscrew it counter-clockwise.
- ▶ Press new bulb ② into the bulb holder and screw it in clockwise.
- ▶ Position the lamp lens and tighten screws ①.

i Vehicles with LED cargo compartment lamp: if an LED is defective, consult a qualified specialist workshop.

Windshield wipers

Switching the windshield wiper on/off

! Do not operate the windshield wipers when the windshield is dry, as this could damage the wiper blades. Moreover, dust that has collected on the windshield can scratch the glass if wiping takes place when the windshield is dry.

If it is necessary to switch on the windshield wipers in dry weather conditions, always use washer fluid when operating the windshield wipers.

! If the windshield wipers leave smears on the windshield after the vehicle has been washed in an automatic car wash, wax or other residues may be the reason for this. Clean the windshield using washer fluid after washing the vehicle in an automatic car wash.

! Vehicles with rain/light sensor:

Switch the wipers off in dry weather. Otherwise, dirt or optical effects may cause undesired windshield wiper sweeps. This could then damage the windshield wiper blades or scratch the windshield.

The windshield will no longer be wiped properly if the wiper blades are worn. Replace the wiper blades twice a year (▷ page 94), ideally in spring and fall.

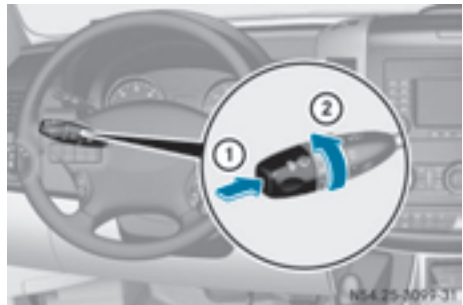

Combination switch

- ▶ Turn the key to position 1 or 2 in the ignition lock.
- ▶ Turn the combination switch in the direction of arrow ② to the appropriate setting depending on the intensity of the rain.
- ▶ **Single wipe:** push the combination switch briefly to the pressure point in the direction of arrow ①.
- ▶ **To wipe with washer fluid:** press the combination switch beyond the pressure point in the direction of arrow ①.

The detent positions of the combination switch correspond to the following wiper speeds:

- 0 Windshield wipers off
- I Intermittent wipe
- II Normal wipe
- III Rapid wipe

i Canada only:

If the windshield wipers are switched on and you stop the vehicle, the windshield wiper speed is reduced. For example, if you have selected level **II** and stop the vehicle, wiping continues with intermittent wipe while the vehicle is stationary. If intermittent wipe is selected, the intervals become longer.

Vehicles with a rain and light sensor: you can use level **I** as the universal setting. The rain and light sensor sets the appropriate wiping frequency automatically, according to the intensity of the rain. When you stop the vehicle, levels **III** and **II** are switched down to level **I** automatically.

The windshield wiper will return to the original level when you drive faster than 5 mph (8 km/h).

You can adjust the sensitivity of the rain and light sensor using the on-board computer (▷ page 173).

Information on checking the washer fluid level can be found in the "Maintenance and care" section (▷ page 224).

Switching the rear window wiper on/off



Combination switch

- ① Rear window wiper switch
- ② To wipe with washer fluid
- ③ **I** To switch on intermittent wiping
- ④ **0** To switch off intermittent wiping
- ⑤ To wipe with washer fluid

▶ Turn the key to position **1** or **2** in the ignition lock.

▶ Turn switch ① to the corresponding position

The rear window wiper switches on automatically if you engage reverse gear and the windshield wipers are on.

Replacing the wiper blades

WARNING

If the windshield wipers begin to move while you are changing the wiper blades, you could be trapped by the wiper arm. There is a risk of injury.

Always switch off the windshield wipers and ignition before changing the wiper blades.

! Never open the hood if a windshield wiper arm has been folded away from the windshield.

Never fold a windshield wiper arm without a wiper blade back onto the windshield/rear window.

Hold the windshield wiper arm firmly when you change the wiper blade. If you release the windshield wiper arm without a wiper blade and it falls onto the windshield, the windshield may be damaged by the force of the impact.

We recommend that you have the wiper blades replaced at a qualified specialist workshop.

! Only hold the wiper blade by the wiper arm. You could otherwise damage the wiper rubber.

The windshield will no longer be wiped properly if the wiper blades are worn. Replace the wiper blades twice a year, ideally in spring and fall.

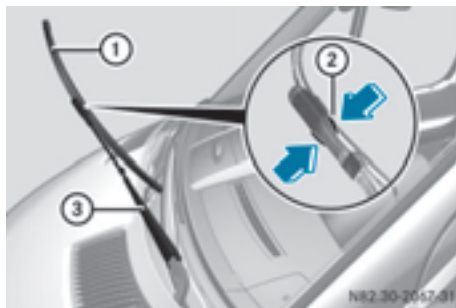

Front windshield wiper arm with wiper blade

- ▶ Fold wiper arm ③ away from the windshield.
- ▶ Set wiper blade ① at right angles to the wiper arm.
- ▶ Press both retaining clips ② together in the direction of the arrow and swing wiper blade ① away from wiper arm ③.
- ▶ Pull wiper blade ① up and out of the retainer on wiper arm ③.
- ▶ Slide new wiper blade ① into the retainer on wiper arm ③.
- ▶ Press new wiper blade ① onto wiper arm ③ until you hear retaining clips ② engage.
- ▶ Fold wiper arm ③ back onto the windshield again.

Problems with the windshield wipers

Problem	Possible causes/consequences and ► Solutions
The windshield wiper jams.	Leaves or snow, for example, may be obstructing the windshield wiper movement. The wiper motor has switched off. <ul style="list-style-type: none"> ► Stop the vehicle as soon as possible, paying attention to road and traffic conditions. ► For safety reasons, you should remove the key from the ignition lock. ► Remove the cause of the obstruction. ► Switch on the windshield wipers again.
The windshield wiper does not move at all.	There is a malfunction in the windshield wiper drive. <ul style="list-style-type: none"> ► Select another wiper speed on the combination switch. ► Have the windshield wipers checked at a qualified specialist workshop.
The windshield washer fluid from the spray nozzles no longer hits the center of the windshield/rear window.	The spray nozzles are misaligned. <ul style="list-style-type: none"> ► Have the spray nozzles checked at a qualified specialist workshop.

Useful information

This Operator's Manual describes all models as well as standard and optional equipment of your vehicle that were available at the time of going to print. Country-specific variations are possible. Note that your vehicle may not be equipped with all of the described functions. This also applies to systems and functions relevant to safety.

Read the information on qualified specialist workshops (▷ page 26).

Overview of climate control systems

Important safety notes

Observe the recommended settings on the following pages. Otherwise, the windows could fog up.

Climate control regulates the temperature and the humidity in the vehicle interior and filters undesirable substances from the air.





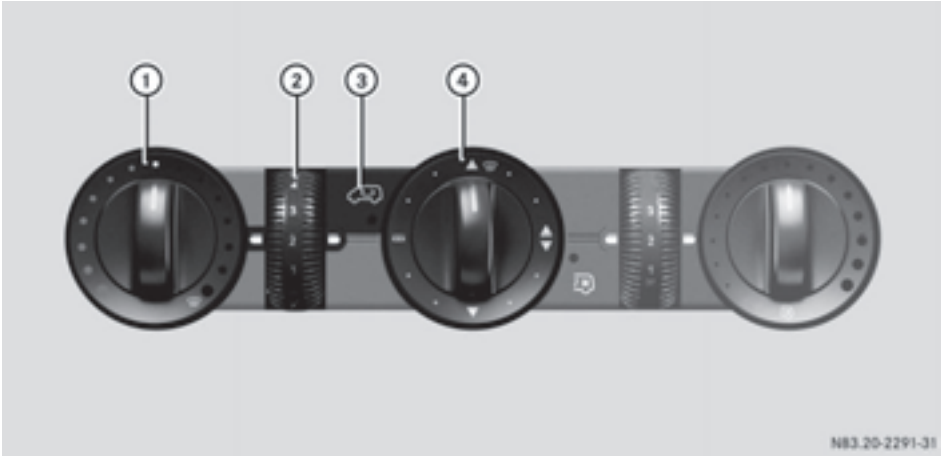

Climate control is only operational when the engine is running. The system only functions optimally when the side windows are closed.

- i** Ventilate the vehicle for a brief period during warm weather. In order to cool the vehicle more rapidly, switch climate control to air-recirculation mode briefly. This will speed up the cooling process and the desired interior temperature will be reached more quickly.
- i** The integrated filter can filter out most particles of dust and completely filters out pollen. A clogged filter reduces the airflow into the vehicle interior. For this reason, you should always observe the interval for replacing the filter, which is specified in the Maintenance Booklet. As it depends on environmental conditions, e.g. heavy air pollution, the interval may be shorter than that stated in the Maintenance Booklet.

Heating control panel





N83.20-2291-31

- ① Sets the temperature (▷ page 102)
 Defrosts the windshield (▷ page 103)
- ②  Sets the airflow (▷ page 102)
 Defrosts the windshield (▷ page 103)
- ③  Activates and deactivates air-recirculation mode (▷ page 104)
- ④ Sets the air distribution (▷ page 102)
  Defrosts the windshield (▷ page 103)

Information on heating

Below, you can find a number of notes and recommendations to help you use the heating optimally.

- Set the temperature control to the middle level. Only change the temperature in small increments.
 If you wish to heat up the vehicle interior as quickly as possible, set the temperature control to the  maximum setting. When the desired interior temperature has been reached, turn the temperature control back down in small steps.
- Only use the settings for defrosting the windshield briefly, until the windshield is clear again.
- Only use air-recirculation mode briefly, e.g. if there are unpleasant outside odors or when in a tunnel. The windows could otherwise fog up as no fresh air is drawn into the vehicle in air-recirculation mode. The indicator lamp in the  button comes on when the function is switched on.

Control panel for the air-conditioning system

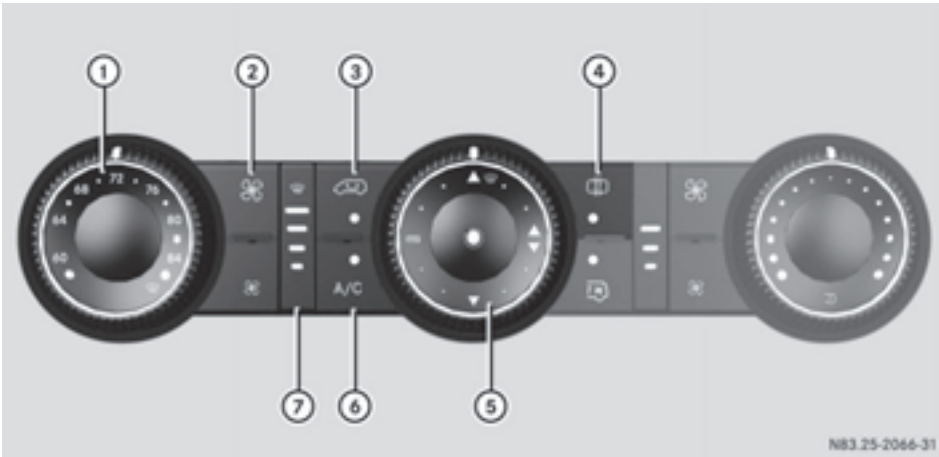

- ① Sets the temperature (▷ page 102)
 Defrosts the windshield (▷ page 103)
- ② Sets the airflow (▷ page 102)
 Increases the airflow
 Reduces the airflow
- ③ Activates and deactivates air-recirculation mode (▷ page 104)
- ④ Switches the reheat function (window air dehumidification) on and off (▷ page 103)
- ⑤ Sets the air distribution (▷ page 102)
 Defrosts the windshield (▷ page 103)
- ⑥ A/C Switches cooling with air dehumidification on/off (▷ page 102)
- ⑦ Blower setting bar display
 Defrosts the windshield (▷ page 103)

Information on the air-conditioning system

Below, you can find a number of notes and recommendations to help you use the air-conditioning system optimally.



- Switch on the cooling with air dehumidification function. The indicator lamp above the rocker switch lights up.
- Set the temperature to 72 °F (22 °C). Only change the temperature in small increments.
- Only use the "Windshield defrosting" function briefly until the windshield is clear again.
- Only use air-recirculation mode briefly, e.g. if there are unpleasant outside odors or when in a tunnel. The windows could otherwise fog up

as no fresh air is drawn into the vehicle in air-recirculation mode.

- Only use reheat mode until the windows are clear again.

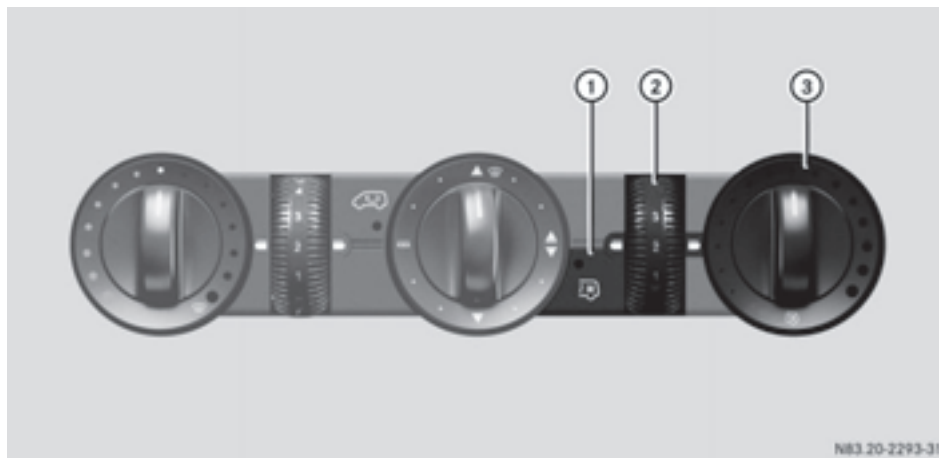
Rear-compartment heating control panel



- ①  Switches rear-compartment heating on and off (▷ page 101)
- ②  Sets the airflow (▷ page 102)
- ③  Sets the temperature (▷ page 102)

Information on rear-compartment heating

For optimum climate control, set the temperature control to the middle level. Only change the temperature in small increments.

Control panel for rear-compartment air-conditioning system

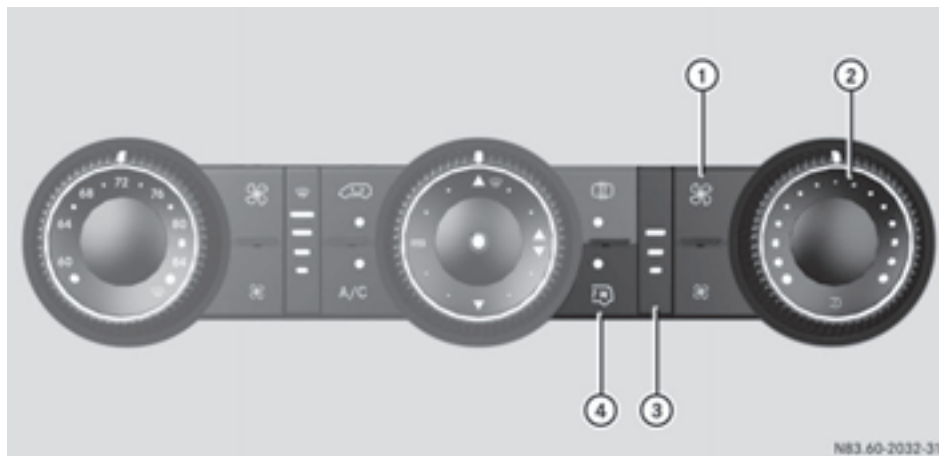

- ① Sets the airflow (▷ page 102)
 - Increases the airflow
 - Reduces the airflow
- ② Sets the temperature (▷ page 102)
- ③ Blower setting bar display
- ④ Switches rear-compartment air-conditioning on and off (▷ page 101)

Information on rear-compartment air conditioning

For optimum climate control, set the temperature control to the middle level. Only change the temperature in small increments.

Operating the climate control system

Switching the climate control on/off

Important information

When the climate control is switched off, air intake and air circulation also stop. Only use this setting for a brief period. Otherwise, the windows could fog up.

Activating/deactivating climate control via the control panel

- ▶ Turn the key to position **2** in the ignition lock.

Vehicle with heating

- ▶ **To switch on:** set airflow control ② down to at least level **1** (▷ page 99).
- ▶ **To switch off:** set airflow control ② up to the **0** position (▷ page 99).

Vehicle with air conditioning

- ▶ **To switch on:** press the button. The blower speeds are shown in bars next to the button.
- ▶ **To switch off:** press the button and, after reaching the lowest blower speed, press it again.

Activating/deactivating rear-compartment climate control via the control panel

- ▶ Turn the key to position **2** in the ignition lock.

Vehicle with rear-compartment heating/ rear-compartment air conditioning

- ▶ **To switch on/off:** press the  switch. If the indicator lamp in the button lights up, the rear-compartment heating/rear-compartment air conditioning is switched on.

Switching the cooling with air dehumidification function on/off

Important information

If you switch off the "Cooling with air dehumidification" function, the air inside the vehicle will not be cooled (in warm weather) or dehumidified. The windows could fog up more quickly.

The cooling with air dehumidification function is only available when the engine is running. The air inside the vehicle is cooled and dehumidified according to the temperature selected.

Condensation may appear on the underside of the vehicle when in cooling mode. This is normal and not a sign that there is a malfunction.

Switching on and off

Vehicle with air conditioning

- ▶ Press the  button. If the indicator lamp in the button lights up, cooling with air dehumidification is switched on.

Setting the temperature

Increasing and reducing temperature in the front compartment via the control panel

Only change the temperature in small increments. Start at the center position, or at 72 °F (22 °C).

- ▶ Switch on climate control (▷ page 101).
- ▶ Turn temperature control ① clockwise to increase or counterclockwise to reduce the temperature (▷ page 99).

Increasing and reducing temperature in the rear compartment via the control panel

Only change the temperature in small increments.





- ▶ Switch on climate control (▷ page 101).
- ▶ Turn rear-compartment temperature control ③ (▷ page 100) or rear-compartment air-conditioning system ② (▷ page 101) clockwise to increase or counterclockwise to reduce the temperature.

i Vehicles with additional air conditioning and heating in the rear compartment: if you set the temperature control to the center position, only one of the two climate control systems works in the rear compartment and in air-recirculation mode (▷ page 104).

Setting the air distribution

Air distribution settings

The air distribution symbols have the following meanings:

-  Directs air through the center and side air vents
-  Directs air to the windshield and the air vents
-  Directs air to the windshield, the air vents and into the footwell
-  Directs air to the air vents and into the footwell

Adjusting

- ▶ Switch on climate control (▷ page 101).
- ▶ Set air-distribution control ④ for the heating (▷ page 98) or air-conditioning system ⑤ (▷ page 99) to the corresponding symbol.

Setting the airflow

- ▶ Switch on climate control (▷ page 101).
- ▶ **Vehicle with heating/rear-compartment heating:** set airflow control ② of the heating (▷ page 98) or of the rear-compartment heating (▷ page 100) to the desired level.
- ▶ **Vehicle with air conditioning/rear-compartment air conditioning:** press the .

button to reduce or the  button to increase the airflow.
The blower speeds are shown in bars next to the buttons.



Defrosting the windows

You can use the "defrosting" function to defrost the windshield or to demist the inside of the windshield and the side windows.





Only use the following settings until the windows are clear again.

- ▶ **Vehicle with window heating:** switch on the front (▷ page 104) and/or rear window defroster (▷ page 104).
- ▶ Switch on climate control (▷ page 101).

Vehicle with heating

- ▶ Set temperature control ① and airflow control ② to  (▷ page 98).
- ▶ Set air-distribution control ④ to   (▷ page 98).
- ▶ Close the center air vents (▷ page 105) and the air outlets for the headroom and the rear compartment (▷ page 106).
- ▶ Direct the side air vents towards the side windows and open the defroster vents for the side windows (▷ page 106).

Vehicle with air conditioning

- ▶ Set temperature control ① to  (▷ page 99).
- ▶ Press the  button until the maximum blower output is reached.
All bars in the display next to the button light up.
- ▶ Set air-distribution control ⑤ to   (▷ page 99).
- ▶ Close the center air vents (▷ page 105) and the air outlets for the headroom and the rear compartment (▷ page 106).
- ▶ Direct the side air vents towards the side windows and open the defroster vents for the side windows (▷ page 106).



Clearing condensation from the windows

Windows fogged up on the inside

You should only select this setting until the windows are clear again.



- ▶ **Vehicle with window heating:** switch on the front (▷ page 104) and/or rear window defroster (▷ page 104).
- ▶ Switch on climate control (▷ page 101).
- ▶ Switch off air-recirculation mode (▷ page 104).

Vehicle with heating

- ▶ Set temperature control ① to a higher temperature (▷ page 98).
- ▶ Set airflow control ② to a higher blower setting. It should be set at least to level two (▷ page 98).
- ▶ Set air-distribution control ④ to   (▷ page 98).

i If the windows still fog up, set the control as described for defrosting (▷ page 103).

Vehicle with air conditioning

- ▶ Activate cooling with air dehumidification (▷ page 102).
- ▶ Press the  button (▷ page 99).
Reheat mode is activated. The indicator lamp in the switch lights up.
To deactivate reheat mode, press the  button again. The indicator lamp in the button goes out.

Windows fogged up on the outside

You should only select this setting until the windshield is clear again.

- ▶ Switch on the windshield wipers (▷ page 93).
- ▶ Switch on climate control (▷ page 101).
- ▶ Adjust air distribution to the footwell (▷ page 102).
- ▶ Close the air vents (▷ page 105).



Window heating

Windshield heater



Windshield heater switch

The windshield heater consumes a lot of power. You should therefore switch it off as soon as the windshield is clear. The windshield heating otherwise switches off automatically after 5 minutes.

- ▶ Start the engine.
- ▶ **To switch on/off:** press the  switch. The indicator lamp in the  button comes on when the windshield heating is switched on.

If the indicator lamp in the  windshield heating button flashes, the on-board voltage is too low. The windshield heating has switched off prematurely or cannot be activated.

- ▶ Switch off any consumers that are not required, e.g. reading lamps or interior lighting.



If enough on-board voltage is available again within 30 seconds, the windshield heating automatically switches on again. It otherwise remains switched off.

Rear window defroster



Rear window defroster switch

The rear window defroster consumes a lot of power. You should therefore switch it off as soon as the window is clear. The rear window heating otherwise only switches off automatically after 12 minutes.

- ▶ Start the engine.
- ▶ **To activate and deactivate:** press the  button. The indicator lamp in the  button comes on when the rear window defroster is switched on.

If the indicator lamp in the  rear window defroster button flashes, the on-board voltage is too low. The rear window defroster has switched off prematurely or cannot be activated.

- ▶ Switch off any consumers that are not required, e.g. reading lamps or interior lighting.

If enough on-board voltage is available again within 30 seconds, the rear window heating automatically switches on again. It otherwise remains switched off.

Switching air-recirculation mode on/off



Important safety notes

When you switch on air-recirculation mode, the windows could fog up more quickly, in particular at low outside temperatures. Only switch on air-recirculation mode for a short time.

You can deactivate the intake of fresh air if unpleasant odors enter the vehicle from outside. The air inside the vehicle will only be circulated.

Heating and air-conditioning system

Air-recirculation mode switches off automatically after about 10 to 30 minutes, depending on the outside temperature.

- ▶ Switch on climate control (▷ page 101).
- ▶ **To activate/deactivate:** press the  button.
If the indicator lamp in the  button lights up, air-recirculation mode is activated.

Rear-compartment heating and rear-compartment air-conditioning system

On vehicles with rear-compartment heating and a rear-compartment air-conditioning system, you can activate or deactivate air-recirculation mode for the rear-compartment climate control.

- ▶ Switch on climate control (▷ page 101).
- ▶ **To activate:** set the temperature control of rear-compartment heating ③ (▷ page 100) or rear-compartment air conditioning system ② (▷ page 101) to the center position. Only one of the two climate control systems in the rear compartment is activated and is in air-recirculation mode.
- ▶ **To deactivate:** turn the temperature control of rear-compartment heating ③ (▷ page 100) or rear-compartment air-conditioning system ② (▷ page 101) clockwise or counterclockwise. Only change the temperature in small increments.

Adjusting the air vents

Important safety notes

WARNING

Very hot or very cold air can flow from the air vents. This could result in burns or frostbite in the immediate vicinity of the air vents. There is a risk of injury.

Make sure that all vehicle occupants always maintain a sufficient distance to the air outlets. If necessary, redirect the airflow to another area of the vehicle interior.

The center and side air vents are adjustable.

On vehicles with a rear-compartment air-conditioning system, you can also adjust the air vents in the roof duct.

- ❗ For virtually draft-free ventilation, adjust the sliders of the center air vents to the center position.

In order to ensure the direct flow of fresh air through the air vents into the vehicle interior, please observe the following notes:

- keep the air inlet grille on the hood free of blockages, such as ice, snow or leaves.
- never cover the vents or the ventilation grilles in the vehicle interior.

Setting the center air vents



- ① Center air vent, left
- ② Center air vent, right
- ③ Thumbwheel for center air vent, right
- ④ Thumbwheel for center air vent, left

- ▶ **To open:** turn thumbwheel ③ to the left or thumbwheel ④ to the right.
- ▶ **To close:** turn thumbwheel ③ to the right or thumbwheel ④ to the left.

Setting the side air vents

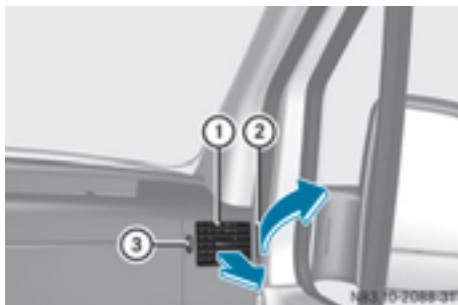

Side air vent (example: right-hand side of the vehicle)

- ▶ **To open:** turn thumbwheel ③ of side air vents ① upward.
 - ▶ **To close:** turn thumbwheel ③ of side air vents ① downward.
- i** If the  symbol can be seen on thumbwheel ③, defroster vent ② is open.

Adjusting air vents for the passenger compartment



Air vents (example: right-hand side of the vehicle)

You can use the air vents to ventilate the vehicle interior on the left and right, in the rear and the headroom.

- ▶ **To open:** for the right-hand side of the vehicle, turn thumbwheel ② to the left or for the left-hand side of the vehicle, thumbwheel ① to the right.
- ▶ **To close:** for the right-hand side of the vehicle, turn thumbwheel ② to the right or for the left-hand side of the vehicle, thumbwheel ① to the left.

Adjusting the air vents in the roof duct

- !** Always leave at least one air vent open. If the rear-compartment air conditioning is switched on and all the air vents are closed, the air-conditioning system may be damaged.



On vehicles with rear-compartment air conditioning, adjustable air vents are integrated into the roof duct.

- ▶ **To adjust the airflow:** open or close the air flap in air vents ① as needed.
- ▶ **To adjust the air distribution:** turn air vent ① to the desired position.

Operating the auxiliary heating system

Important safety notes

DANGER

If the exhaust pipe is blocked or adequate ventilation is not possible, poisonous gases such as carbon monoxide (CO) may enter the vehicle. This is the case, for example in enclosed spaces or if the vehicle gets stuck in snow. There is a risk of fatal injury.

Switch the auxiliary heating off in enclosed spaces without extraction systems, e.g. in garages. If the vehicle is stuck in snow and you have to leave the auxiliary heating running, keep the exhaust pipe and the area around the vehicle free of snow. To ensure an adequate supply of fresh air, open a window on the side of the vehicle that is not facing into the wind.

⚠ WARNING

When the auxiliary heating is switched on, parts of the vehicle can become very hot, e.g. the exhaust system.

Flammable materials such as leaves, grass or twigs may ignite if they come into contact with:

- hot parts of the exhaust system
- the exhaust gas itself

There is a risk of fire.

When the auxiliary heating is switched on, make sure that:

- no flammable materials come into contact with hot vehicle components
- the exhaust gas can escape from the exhaust pipe unhindered
- the exhaust gas does not come into contact with flammable materials.

! Turn on the auxiliary heating at least once a month for approximately 10 minutes. The auxiliary heating could otherwise be damaged.

! Make sure that the flow of hot air is not blocked. The auxiliary heating will otherwise overheat and switch off.

Your vehicle may be equipped with either an auxiliary hot-water heater or an auxiliary warm-air heater. Adjustment and operation of the:

- hot-water auxiliary heater is done via the on-board computer and with the auxiliary heating button in the control panel (▷ page 108) or with the remote control (▷ page 109).
- auxiliary warm-air heater is done via the timer above the overhead control panel (▷ page 114).

The auxiliary heating works independently of the engine and supplements the climate control system in the vehicle. The auxiliary heating heats the air in the vehicle interior to the temperature set.

If your vehicle is equipped with a hot-water auxiliary heater, the auxiliary heating also keeps the coolant warm. This way, the load on the engine is minimized and fuel is saved.

The heater booster function (▷ page 111) of the auxiliary heating supports the climate control

system when the engine is running and the outside temperature is low.

You can use the auxiliary heating at an outside temperature of up to 39 °F (4 °C). At an outside temperature above 39 °F (4 °C) the auxiliary heating system and the heater booster function switch off automatically.

Hot-water auxiliary heating**Heating time**

The heating time when operating the auxiliary heating with the vehicle is stationary without the engine running depends on the outside temperature and the electrical consumers switched on.

Outside temperature	Heating time	Possible startup procedures
Above 23 °F (-5 °C)	Approx. 20 minutes	6
23 °F (-5 °C) to 5 °F (-15 °C)	Approx. 40 minutes	3
Below 5 °F (-15 °C)	Approx. 50 minutes	2

You can then switch on the auxiliary heating again.

If you do not start the engine for a while, the total duration of heating is limited to a maximum of 120 minutes to protect the starter battery. Switching on the auxiliary heating is then automatically disabled. You can, for example, switch on the auxiliary heating without the engine running if the outside temperature is -5 °F (-20 °C) a maximum of two times. If you try it again, the indicator lamps in the  button (▷ page 108) flash alternately for approximately 2 minutes to signal switch-on interlock. The auxiliary heating cannot be switched on without starting the engine.

When the condition of charge of the starter battery is sufficient again, the switch-on interlock will be deactivated. To charge the starter battery, let the engine run. The engine run time required to reach the necessary condition of charge depends on the outside temperature and on the electrical consumers switched on.

Outside temperature	Engine runtime
Above 32 °F (0 °C)	at least 10 minutes
32 °F (0 °C) to 14 °F (-10 °C)	at least 15 minutes
Below 14 °F (-10 °C)	at least 20 minutes

Before switching on

- ▶ Check the fuel level and top up if necessary. The auxiliary heating is operated directly using the vehicle's fuel. The tank must be at least a quarter full to ensure that the auxiliary heating functions.
- ▶ Switch on climate control (▷ page 101).
- ▶ Set the temperature control to the desired temperature (▷ page 102).
- ▶ Set the air distribution as required (▷ page 102).
- ▶ Open the center (▷ page 105) and side air vents (▷ page 106) and set them to the middle position.

i The auxiliary heating automatically switches to heater booster mode after the engine is started.

Operating with the button (control panel)

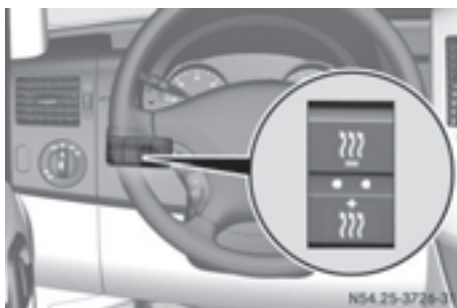

i Switch the heater booster function on or off with the  button (▷ page 111).

- ▶ **To activate the auxiliary heating system:** press and hold the upper section of the  switch for longer than 2 seconds. The red indicator lamp in the button lights up. The auxiliary heating heats or ventilates the

interior to the temperature that you have set. The blower switches to the first level.

- ▶ **To deactivate the auxiliary heating:** press the upper section of the  switch.
- or
- ▶ Turn the key in the ignition lock to position **0**. The red indicator lamp in the button goes out. The auxiliary heating operates for another 2 minutes and then switches off automatically.

Selecting a switch-on time



Important information

You can use the on-board computer to define up to three switch-on times, one of which can be selected.







The yellow indicator lamp in the  button goes out after 30 minutes, if you:

- have selected the switch-on time and
- turn the key to position **0** in the ignition lock

On-board computer without steering wheel buttons

- ▶ Turn the key to position **2** in the ignition lock.
- ▶ Press the  button. The  symbol flashes in the display.

or

- ▶ Press the  menu button on the instrument cluster repeatedly until the  symbol flashes in the display.
- ▶ Use the  or  buttons on the instrument cluster to select the switch-on time **1** to **3**. The switch-on time selected is displayed.
- ▶ Wait 10 seconds for the standard display to appear. The switch-on time is selected. The yellow indicator lamp in the  button lights up. If you do not preselect a switch-on time, and **--:--** is shown in the display, this means that the automatic switch-on mode is switched off. The yellow indicator lamp in the  button goes out.

On-board computer with steering wheel buttons

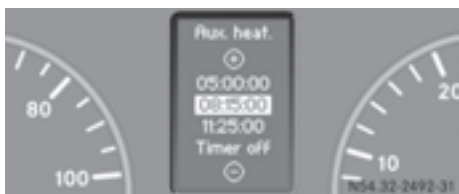

- ▶ Turn the key to position **2** in the ignition lock.
- ▶ Press the button. The **Aux. heat** submenu is shown in the display. If no switch-on time has been selected, the selected switch-on time is highlighted or **Timer off** is highlighted.
- ❗ You can also access the **Aux. heat.** sub-menu via the **Settings** (▶ page 168) menu.
- ▶ Use the or button on the steering wheel to select the desired switch-on time. Use the **Timer off** setting to deactivate automatic switch-on.
- ▶ Press the button on the steering wheel. The switch-on time is selected. The yellow indicator lamp in the button lights up.

Setting the switch-on time

- ▶ Use the same method to select a switch-on time as described in the "Preselecting a switch-on time" section.

On-board computer without steering wheel buttons

- ▶ Press the reset button on the instrument cluster. The hour display flashes.
- ▶ Use the and buttons on the instrument cluster to set the hours.
- ▶ Press the reset button. The minute display flashes.
- ▶ Use the and buttons to set the minutes. The switch-on time is set and selected.

On-board computer with steering wheel buttons

- ▶ Press the button on the steering wheel. The display shows the **Hours** menu.
- ▶ Use the and buttons on the steering wheel to set the hours.

- ▶ Press the button. The display shows the **Minutes** menu.
- ▶ Use the and buttons to set the minutes.
- ▶ Press the button. The switch-on time is set and selected.

Operation with the remote control

Important information

You can switch the auxiliary heating on/off and set the operating duration using the remote control. You can use up to 4 remote control units on the vehicle. These must be synchronized for the receiver in your vehicle (▶ page 110).

The remote control has a maximum range of approximately 600 meters. This range is reduced by:

- sources of interference
- solid objects between the remote control and the vehicle
- the remote control being in an unfavorable position in relation to the vehicle
- transmitting from an enclosed space

Overview of the remote control



- ① Indicator lamp
- ② To confirm settings
- ③ To switch the remote control on/off, set the operating duration or end or cancel settings

Indicator lamp lights up in various ways to show different operating modes:

Signaling	Meaning
Lights up red	Remote control switched on
	Data transfer

Signaling	Meaning
Flashes red	Auxiliary heating switched off
Lights up green	Auxiliary heating switched on
Flashes green	Change operating duration active
Flashes alternately red and green	Remote control in synchronizing mode

i When the remote control battery is weak, indicator lamp ① flashes red rapidly. Replace the remote control battery (▷ page 111).

You can find information on further lamp statuses in the "Problems with the hot-water auxiliary heater" section (▷ page 113).

Switching the remote control on/off

The remote control switches to standby mode after 10 seconds. Indicator lamp ① goes out.

▶ **To switch on:** press and hold the  button until indicator lamp ① lights up red.

If a connection between the remote control and the receiver in the vehicle has been established and indicator lamp ①:

- flashes red, the auxiliary heating is switched off.
- lights up green, the auxiliary heating is switched on.

▶ **To switch off:** press and hold the  button until indicator lamp ① goes out.

Switching the auxiliary heating on/off

▶ Switch on the remote control.

▶ **To switch on:** when indicator lamp ① flashes red, press the  button.

During data transmission, indicator lamp ① lights up red.

When indicator lamp ① lights up green, the auxiliary heating is switched on.



▶ **To switch off:** when indicator lamp ① lights up green, press the  button.

During data transmission, indicator lamp ① lights up red.

When indicator lamp ① flashes red, the auxiliary heating is switched off.

Changing the operating duration

▶ Switch on the remote control.

▶ When indicator lamp ① flashes red, press  and  simultaneously. Indicator lamp ① flashes green.

▶ Press the  button repeatedly until the desired operating duration is shown.

- 20 minutes

Indicator lamp ① flashes green twice.

- 30 minutes

Indicator lamp ① flashes green three times.

- 40 minutes

Indicator lamp ① flashes green four times.

▶ Press the  button.

During data transmission, indicator lamp ① lights up red.

If indicator lamp ① emits two long, green flashes, the selected operating duration is stored.

i If no adjustment is made, indicator lamp ① flashes six times and the remote control goes into standby mode.

Synchronizing the remote control

▶ Press the  auxiliary heating button in the control panel (▷ page 108) for longer than 10 seconds.

When you press and hold the  button, the red indicator lamp lights up in the button.

When the red indicator lamp in the  button flashes, the receiver in the vehicle is ready for synchronizing.

▶ Press and hold the  remote control button until indicator lamp ① lights up red.

If there is an active connection between the remote control and the receiver, indicator lamp ① flashes alternately red and green. The remote control is in synchronizing mode.

i If you press the  button again on the remote control after starting synchronization, you will only synchronize this remote control unit with the receiver. Any other remote control units that were synchronized will be cleared. Indicator lamp ① flashes alternately red and green (very slowly).

▶ Press the  button on the remote control. During data transmission, indicator lamp ① lights up red.

When remote control indicator lamp ① emits two long green flashes, the selected operat-

ing time is synchronized. The indicator lamp in the  auxiliary heating button goes out.

Switching the heater booster function on/off



Vehicles with auxiliary heating



Vehicles with heater booster function

At outside temperatures of up to 39 °F (4 °C) the fuel-fired heater booster system heats the vehicle interior as quickly as possible when the engine is running.

The auxiliary heating automatically switches to heater booster mode after the engine is started.

At an outside temperature above 39 °F (4 °C) the auxiliary heating system and the heater booster function switch off automatically.

If you switch off the engine without switching off the heater booster function, the system will be switched on the next time the engine is started (memory function).

i Switch the auxiliary heating on or off with the  button (▷ page 108).

► **To switch on/off:** press the  button. If the indicator lamp in the button lights up, the heater booster function is switched on.

After switching off, the auxiliary heating operates for about another 2 minutes and then switches off automatically.

Replacing the remote control battery

WARNING

Batteries contain toxic and corrosive substances. If batteries are swallowed, it can result in severe health problems. There is a risk of fatal injury.

Keep batteries out of the reach of children. If a battery is swallowed, seek medical attention immediately.

Environmental note



Batteries contain dangerous substances. It is against the law to dispose of them with the household rubbish. They must be collected separately and recycled to protect the environment.



Dispose of batteries in an environmentally friendly manner. Take discharged batteries to a qualified specialist workshop or a special collection point for used batteries.

If the indicator lamp on the remote control flashes red rapidly, the remote control battery is discharged. You should replace the remote control battery.

You need a battery of the type CR2430, which can be obtained at any qualified specialist workshop.



- ▶ Remove battery cover ② using a suitable implement, e.g. a coin, by turning it counter-clockwise.
- ▶ Check the seal on battery cover ② for damage and, if necessary, replace.
- ▶ Remove old batteries ③.
- ▶ Insert new, clean battery ③ into the battery tray with the positive pole facing upwards. Use a lint-free cloth to do so.
- ▶ Position battery cover ② so that mark ① on the raised area points between two recesses ④.
- ▶ Turn battery cover ② using a suitable implement, e.g. a coin, clockwise to the stop.
- ▶ Check all the functions of the remote control (▷ page 109).

Problems with the hot-water auxiliary heating

Problem	Possible causes/consequences and ► Solutions
The indicator lamp on the remote control flashes red rapidly.	<p>The remote control battery is discharged. Data transmission is not possible.</p> <p>► Replace the remote control battery (▷ page 111).</p>
The indicator lamp on the remote control flashes red and green in rapid succession.	<p>There is no connection between the remote control and the receiver in the vehicle.</p> <p>► Change your position in relation to the vehicle, e.g. hold the remote control higher or to the side.</p> <p>► Move closer.</p> <p>If you cannot establish a connection and the auxiliary heating is switched on, it can then only be deactivated using the  button (▷ page 108).</p> <p>or</p> <p>Several remote controls are being used at the same time.</p> <p>► Switch on the remote control again after a short while (▷ page 110).</p> <p>or</p> <p>The remote control is not synchronized.</p> <p>► Synchronize the remote control (▷ page 110).</p>
The indicator lamp on the remote control slowly flashes red and green alternately.	<p>The remote control is being synchronized.</p> <p>► Wait until the remote control synchronization process is complete (▷ page 110).</p>
The remote control for the auxiliary heating cannot be switched on.	<p>The remote control battery is discharged.</p> <p>► Replace the remote control battery (▷ page 111).</p>
The auxiliary heating does not switch on.	<p>The outside temperature is above 39 °F (4 °C). The auxiliary heating switches off automatically.</p>
The auxiliary heating switches off automatically and/or cannot be switched on.	<p>The fuel tank is less than ¼ full. The auxiliary heating switches off automatically.</p> <p>► Refuel at the nearest gas station.</p> <p>► Then, start the auxiliary heating several times until the fuel lines are full.</p> <p>or</p> <p>The low-voltage protection system integrated in the control unit switches off the auxiliary heating because the on-board voltage is less than 10 V.</p> <p>► Have the alternator and battery checked.</p> <p>or</p>

Problem	Possible causes/consequences and ► Solutions
	The fuse is blown. ► Replace the fuse; see the "Fuse allocation" supplement. ► Have the cause of the blown fuse determined at a qualified specialist workshop. or A malfunction has occurred. ► Switch the ignition on and off twice. If the auxiliary heating still cannot be switched on, the heating device is faulty. ► Have the auxiliary heating checked at a qualified specialist workshop.
	The coolant level is too low. ► Check the coolant level and add more coolant if necessary (▷ page 222).
The auxiliary heating is overheated.	

Auxiliary warm-air heater

Operation with the timer

Important safety notes

⚠ DANGER

If a switch-on time has been selected, the auxiliary heating switches on automatically.

- If the ventilation is insufficient, poisonous exhaust gases can collect, in particular carbon monoxide. This is the case in enclosed spaces, for example. There is a risk of fatal injuries.
- If highly flammable substances or flammable materials are nearby, there is a risk of a risk of fire and explosion.

Always deactivate the preselected switch-on times if you stop the vehicle in such or similar situations.

Use the timer to:

- activate and deactivate immediate heating mode
- set up to three switch-on times
- set the operating duration to between 10 and 120 minutes or to continuous operation
- set the heating level (preselected temperature) to a range between 10 and 30

Timer overview

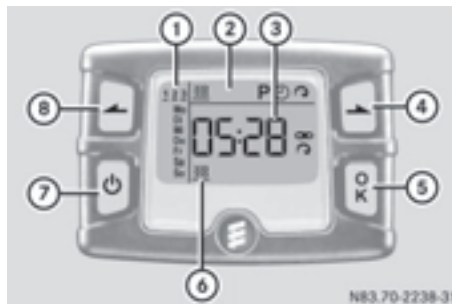

Timer above the overhead control panel

① **Program column**

Sets preselection memory 1 – 3 (▷ page 115)

Sets weekday (Mon. – Sun.) (▷ page 115)

② **Menu bar**

Switches immediate heating mode on/off (▷ page 115)

Sets the program times (▷ page 115)

Sets the day, time and the operating duration (▷ page 115)

Sets the heating level (▷ page 116)

③ **Display panel for: time, heating level and operating duration**

Continuous operation mode active

Heating level set

- ④ Selects options in program column ① or menu bar ② (forwards)
Increases values
- ⑤ Confirms a selection or setting
- ⑥ **Status bar**
 Heating mode activated
- ⑦ Activates the timer
Cancels or ends settings in a menu
- ⑧ Selects options in program column ① or menu bar ② (backwards)
Reduces values

Activating the timer

The timer switches to standby mode after 10 seconds. The display goes off.









- ▶ Press and hold the  button until the menu bar appears in the display and the time is shown.

Setting the day, time and operating duration





You must reset the day, time, and default value for the operating duration:

- during initial operation
- after a voltage supply interruption (e.g. if the battery has been disconnected)
- after a malfunction.





You can find information on malfunctions in the "Problems with the auxiliary warm-air heater" section (▷ page 117).











- ▶ Press the  or  button until the  symbol in menu bar ② flashes.
- ▶ Press the  button.
In program column ①, the day selected flashes.
- ▶ Press the  or  button to set the desired day.
- ▶ Press the  button.
The day selected is stored. The hour setting of the clock flashes.
- ▶ In the same way, set the hour and subsequently the minutes, then confirm by pressing the  button.
The time is stored. Program column ① disappears and the operating duration flashes.

- ① The operating duration set is the default setting for immediate heating mode. You can set the operating duration from 10 to 120 minutes or activate continuous operation.

- ▶ Using the  or  button, set the minute value or select the  symbol for continuous operation.
- ▶ Press the  button.
The operating duration is stored. The time is shown.

Switching immediate heating mode on/off

- ▶ **To switch on:** press the  or  button until the  symbol in the menu bar flashes.
- ▶ Press the  button.
The operation duration flashes in the display.
- ① You can preset the default value that is shown (▷ page 115).

- ▶ Using the  or  button, set the minute value (10 to 120) or select the  symbol for continuous operation.
- ▶ Press the  button.
Immediate heating mode is activated. The time and the  symbol appear.
- ▶ **To switch off:** press the  or  button until the  symbol flashes in the menu bar, and then press the  button.
Immediate heating mode is deactivated. The  symbol disappears.
The auxiliary heating operates for another 2 minutes and then switches off automatically.

- ① If you switch off the ignition during immediate heating (operating duration 10 to 120 minutes), you also switch off the immediate heating mode. The auxiliary heating operates for another two minutes and then switches off automatically.

If you have set continuous operation as the operating duration and you switch off the ignition, the auxiliary heating switches off automatically after about 15 minutes. If, in the remaining time, the ignition is switched on again, continuous operation of the auxiliary heating continues.

Setting the preselection time















WARNING

The auxiliary heating must not be operated if there are highly flammable substances nearby or in enclosed spaces without an extraction system. Make sure that the auxiliary heating is not switched on automatically by the timer in such places. If this possibility

exists, deactivate the respective programmed time.

You can set three preselection times using the timer.



After a malfunction or if the battery has been disconnected, you must set the preselection times again. You can find information on malfunctions in the "Problems with the auxiliary warm-air heater" section (▷ page 117).

- ▶ Press the  or  button until the  symbol in the menu bar flashes.
 - ▶ Press the  button.
In the program column, the  preselection memory numbers appear. The selected preselection memory flashes.
 - ▶ Press the  or  button to select the desired preselection memory.
 - ▶ Press the  button.
The preselection memory is selected. The days are shown.
 - ▶ Set the day and time as described in the "Setting the day, time and operating duration" section (▷ page 115).
The preselection time is stored. The program column disappears. In the display panel, the **on** message and the  symbol appear.
 - ▶ Press the  button.
The operating duration flashes.
 - ▶ Press the  or  button to set the minute value (10 to 120).
 - ▶ Press the  button.
The operating duration for the preselection time is saved. The time and number of the selected preselection memory are shown.
-  The preselection memory that will be activated next is underlined. Additionally, the day that is set appears.

Deactivating the preselection time

- ▶ Carry out the steps as described in the "Setting the preselection time" section.









If the  symbol in the status bar is shown:

- ▶ Press the  or  button until the **off** message in the display panel is shown.
- ▶ Press the  button.
The preselection time is deactivated. The time is shown.

Setting the heating level

You can set the heating level to a range between 10 and 30.

The heating level corresponds to a preselection temperature for the vehicle interior. This is a guide value and may, depending on the outside temperature, differ from the interior temperature.

- ▶ Press the  or  button until the  symbol in the menu bar flashes.
- ▶ Press the  button.
The heating level display flashes.
- ▶ Using the  and  buttons, set the desired heating level to a range between 10 and 30.
- ▶ Press the  button.
The heating level is set and the  symbol appears.

Problems with the auxiliary warm-air heater

Problem	Possible causes/consequences and ► Solutions
The auxiliary heating does not switch on.	The outside temperature is above 39 °F (4 °C). The auxiliary heating switches off automatically.
The auxiliary heating switches off automatically and/or cannot be switched on.	The fuel tank is less than ¼ full. The auxiliary heating switches off automatically. <ul style="list-style-type: none"> ► Refuel at the nearest gas station. ► Then, start the auxiliary heating several times until the fuel lines are full. or
	The low-voltage protection system integrated in the control unit switches off the auxiliary heating because the on-board voltage is less than 10 V. <ul style="list-style-type: none"> ► Have the alternator and battery checked. or
	The fuse is blown. <ul style="list-style-type: none"> ► Replace the fuse; see the "Fuse allocation" supplement. ► Have the cause of the blown fuse determined at a qualified specialist workshop.

Operating the cargo compartment air vents

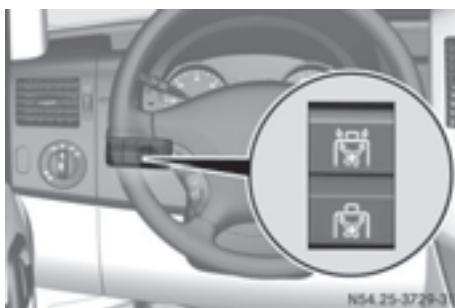

- **To activate and ventilate:** press the lower section of the  switch. The roof ventilator feeds fresh air into the cargo compartment.
- **To switch off:** set the switch to the middle position.

If your vehicle is equipped with a roof ventilator, you can ventilate and extract air from the cargo compartment.

- Turn the key to position **2** in the ignition lock.
- **To activate and extract air:** press the upper section of the  switch. The roof ventilator removes used air from the cargo compartment.

Useful information

This Operator's Manual describes all models as well as standard and optional equipment of your vehicle that were available at the time of going to print. Country-specific variations are possible. Note that your vehicle may not be equipped with all of the described functions. This also applies to systems and functions relevant to safety.

Read the information on qualified specialist workshops (▷ page 26).

Breaking-in notes

The first 1000 miles (1500 km)

New or replaced brake pads and brake disks only reach their optimum braking effect after a few 100 miles (a few 100 kilometers). Until then, compensate for this by applying greater force to the brake pedal.

For the service life and economy of your vehicle it is crucial that you break in the engine with due care.

- Therefore, protect the engine for the first 1000 miles (1500 km) by driving at varying vehicle and engine speeds.
- Avoid overstraining the vehicle and high engine speeds during this period, e.g. driving at full throttle. Do not exceed $\frac{3}{4}$ of the maximum speed for each gear.
- Do not change down a gear manually in order to brake.
- Try to avoid depressing the accelerator pedal beyond the point of resistance (kickdown).
- The shift ranges **3**, **2** or **1** should only be engaged when driving slowly, e.g. when driving in mountainous terrain.

After 1000 miles (1500 km), you can increase the engine speed gradually and accelerate the vehicle to full speed.

- i** You should also observe these notes on breaking-in if the engine or parts of the drive train on your vehicle have been replaced.

Driving

Important safety notes

WARNING

If you switch off the ignition while driving, safety-relevant functions are only available with limitations, or not at all. This could affect, for example, the power steering and the brake boosting effect. You will require considerably more effort to steer and brake. There is a risk of an accident.

Do not switch off the ignition while driving.

WARNING

If the parking brake has not been fully released when driving, the parking brake can:

- overheat and cause a fire
- lose its hold function.

There is a risk of fire and an accident. Release the parking brake fully before driving off.

If you park the vehicle for more than three weeks:

- connect the batteries to a trickle charger or
- disconnect the vehicle's starter battery or
- switch off the electrical system using the battery main switch (▷ page 118) and
- disconnect the vehicle's auxiliary battery

Otherwise, you need to check the battery's condition of charge every three weeks, since standby power consumption can drain the battery. If the battery voltage is lower than 12.2 V, the battery must be charged. Otherwise, the battery may be damaged by exhaustive discharging.

Be sure to observe the notes on disconnecting and charging the batteries under "Battery" (▷ page 227). You can obtain information about trickle chargers from a qualified specialist workshop.

Battery isolating switch

Important safety notes

- !** Make sure that the key is in position **0** in the ignition lock and wait at least 20 seconds before disconnecting or connecting the bat-

tery isolating switch. You could otherwise damage electrical system components.

You can use the battery isolating switch to disconnect the power supply to all your vehicle's consumers. This will prevent uncontrolled battery discharge caused by off-load current consumption.

If your vehicle is equipped with an auxiliary battery in the engine compartment, you will need to disconnect both batteries. Only then is the electrical system fully disconnected from the power supply.

- i** Only switch the vehicle to de-energized using the battery main switch if:
- the vehicle is stationary for a lengthy period
 - it is absolutely necessary

After the power supply has been activated, you will need to reset the side windows (> page 71).

Switching off the power supply

! When you clamp the connector under the accelerator pedal, make sure that the connector does not become damaged or dirty. It may otherwise not be possible to restore the electrical connection when the parts are reassembled.

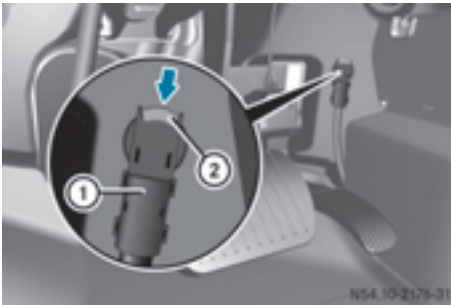

Battery main switch to the left of the center console

- ▶ Remove the key from the ignition lock and wait for about 20 seconds.
- ▶ Press button **2** in the direction of the arrow and hold.

- ▶ Pull connector **1** from the earth pin.
- ▶ Push connector **1** as far to the side as possible so that it cannot make contact with the earth pin.
All starter battery consumers are disconnected from the power supply.

Switching on the power supply

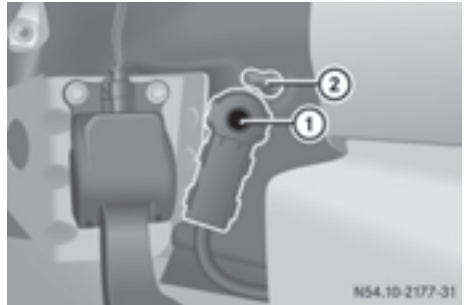

- ▶ Insert the key into the ignition lock.
- ▶ Press connector **1** onto earth pin **2** until you feel it engage and the lock inhibitor is released.
Connector **1** must be in full contact with earth pin **2**.
All consumers are reconnected to the DC power supply.

Key positions



- 0** To insert and remove the key, lock the steering wheel
- 1** To unlock the steering wheel, power supply for some consumers (e.g. the radio)
- 2** To switch on the ignition. Power supply for all consumers, preglow and drive position
- 3** To start the engine

On vehicles with a battery main switch, you must first switch on the power supply (▷ page 118).

- i** To unlock the steering, move the steering wheel slightly while turning the key to position 1.

Preparing for a journey

Visual check of the vehicle exterior

► In particular, check the following components on the vehicle, and on the trailer as necessary:

- license plates, vehicle lighting, turn signals, brake lamps and wiper blades for dirt and damage
- tires and wheels for firm seating, correct tire pressure and general condition
- trailer tow hitch for play and security

The trailer coupling is one of the most important vehicle parts with regard to road safety. The separate instructions issued by the manufacturer pertaining to operation, care and maintenance should be observed.

- that contour markings on attachments and bodies are in good condition
- Rectify any noticeable defects before commencing the journey.

Checks in the vehicle

Emergency equipment and first-aid kit

- Check the equipment to make sure that it is accessible, complete and ready for use.

The first aid and breakdown assistance equipment is in the front door stowage compartments and behind the driver's seat.

Vehicle lighting

- Turn the key to position **2** in the ignition lock.
- Check the lighting system with the aid of a second person.
- Replace defective bulbs (▷ page 86).

Before driving off

WARNING

Objects in the driver's footwell may restrict the clearance around the pedals or block a

depressed pedal. This jeopardizes the operating and road safety of the vehicle. There is a risk of an accident.

Stow all objects securely in the vehicle so that they do not get into the driver's footwell.

When using floor mats or carpets, make sure that they are properly secured so that they do not slip or obstruct the pedals. Do not place several floor mats or carpets on top of one another.

WARNING

Unsuitable footwear can hinder correct usage of the pedals, e.g.:

- shoes with thick soles
- shoes with high heels
- slippers

There is a risk of an accident.

Wear suitable footwear to ensure correct usage of the pedals.

- Secure the load as per the loading guidelines (▷ page 212).
- Stow luggage items securely. Secure the load as per the loading guidelines (▷ page 212).
- Make sure that the floor mats and carpets are properly secured so that they cannot slip and obstruct the pedals.
- Close all doors.

Starting the engine

WARNING

Combustion engines emit poisonous exhaust gases such as carbon monoxide. Inhaling these exhaust gases leads to poisoning. There is a risk of fatal injury. Therefore never leave the engine running in enclosed spaces without sufficient ventilation.

- !** Do not depress the accelerator pedal when starting the engine.
- Before starting the engine, make sure that:

- all the doors are closed.
- all the vehicle occupants are wearing their seat belts correctly.
- the parking brake is applied.

i If you depress the brake pedal before starting the engine, the pedal travel is short and pedal resistance is high.

If you depress the brake pedal again after starting the engine, pedal travel and resistance will be back to normal again.

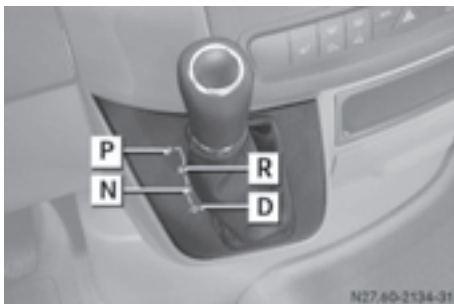

Gearshift pattern

- P** Park position with parking lock
- R** Reverse gear
- N** Neutral
- D** Drive

▶ Move the selector lever to position **P**. The display in the instrument cluster shows **P**:

- on vehicles with steering wheel buttons (▷ page 167)
- on vehicles without steering wheel buttons (▷ page 163)

i You can also start the engine in neutral **N**.

▶ Turn the key to position **2** in the ignition lock. The  preglow indicator lamp in the instrument cluster lights up briefly.

▶ Once the  preglow indicator lamp goes out, turn the key to position **3** in the ignition lock and release it as soon as the engine is running.

i You can start the engine without preglow when the engine is warm.

The preglow system is malfunctioning if the  preglow indicator lamp lights up for approximately 1 minute:

- after the ignition is switched on
- while the engine is running

At extremely low outside temperatures you may then no longer be able to start the engine. Have the malfunction rectified at a qualified specialist workshop.

i Depending on the equipment installed, the vehicle either automatically locks centrally after switching on the ignition or after pulling away. The locking knobs in the doors drop down.

You can open the doors from the inside at any time.

Automatic door locking can be deactivated (▷ page 64).

Driving off

WARNING

If the engine speed is above the idling speed and you engage transmission position **D** or **R**, the vehicle could pull away suddenly. There is a risk of an accident.

When engaging transmission position **D** or **R**, always firmly depress the brake pedal and do not simultaneously accelerate.

! Only shift into reverse gear **R** when the vehicle is stationary. Otherwise, you could damage the transmission.

▶ Depress the brake pedal and keep it depressed.

The selector lever lock is released.

▶ Move the selector lever to position **D** or **R**. On vehicles with a reverse warning feature, when reverse gear is engaged a warning tone sounds to alert other road users (▷ page 122).

▶ Release the parking brake (▷ page 131). The  indicator lamp in the instrument cluster goes out.

▶ Release the brake pedal.

▶ Carefully depress the accelerator pedal.

i After pulling away or switching on the ignition, the vehicle automatically locks centrally. The locking knobs in the doors drop down.

You can open the doors from the inside at any time.

You can also deactivate the automatic locking feature (▷ page 64).

Reverse warning device

WARNING

Other road users may ignore or fail to hear the warning tone of the reverse warning feature.

There is a risk of injury if you fail to ensure that the area in which you are maneuvering is clear.

Make sure that there are no persons or objects in the area in which you are maneuvering. It may be necessary to enlist the help of a second person when maneuvering.



The reverse warning feature is a system designed to assist you in ensuring the safety of other road users.

A warning signal sounds to alert other road users when reverse gear is engaged. The volume of the warning tone can be reduced for nighttime driving.

► **To reduce the volume of the warning tone:**
engage reverse gear twice in quick succession.

The warning tone is now quieter.

i The warning tone sounds at a normal volume by default. The volume of the warning tone has to be reduced each time you engage reverse gear if necessary.

Problems with the engine	
Problem	Possible causes/consequences and ► Solutions
<p>The engine does not start. The starter motor can be heard.</p>	<p>There is air in the fuel system.</p> <ul style="list-style-type: none"> ► Turn the key back to position 0 in the ignition lock before attempting to start the engine again. ► Start the engine again. Please bear in mind that lengthy and frequent starting attempts will drain the battery. <p>If the engine does not start after several attempts:</p> <ul style="list-style-type: none"> ► Consult a qualified specialist workshop.
<p>The engine does not start. The starter motor can be heard. The reserve fuel warning lamp is lit and the fuel gage is at 0.</p>	<p>The fuel tank has been run dry.</p> <ul style="list-style-type: none"> ► Refuel the vehicle. <p>If you drive until the fuel tank is completely empty, air may get into the fuel system. If the engine does not start after refueling, bleed the fuel system as follows:</p> <ul style="list-style-type: none"> ► Turn the key to position 2 in the ignition for approximately 10 seconds. ► Start the engine continuously for a maximum of 60 seconds. <p>If the engine does not start:</p> <ul style="list-style-type: none"> ► Wait approximately 2 minutes. ► Restart the engine continuously for a maximum of 60 seconds. ► If the engine still fails to start, do not continue trying to start it. ► Consult a qualified specialist workshop.
<p>The vehicle cannot be driven at a speed exceeding 5 mph (8 km/h).</p> <p>The yellow  Check Engine lamp and the yellow  DEF indicator lamp² light up.</p>	<p>The exhaust gas aftertreatment system is defective or an emissions-relevant malfunction has occurred.</p> <p>This malfunction or defect can damage the exhaust gas aftertreatment.</p> <ul style="list-style-type: none"> ► Observe the messages in the display: <ul style="list-style-type: none"> • on vehicles without steering-wheel buttons (► page 178) • on vehicles with steering wheel buttons (► page 187).
<p>The engine does not start. The starter motor cannot be heard.</p>	<p>The battery isolating switch is switched off.</p> <ul style="list-style-type: none"> ► Switch on the power supply (► page 118).

² Only vehicles without steering-wheel buttons.

Problem	Possible causes/consequences and ► Solutions
The engine does not start. The starter motor cannot be heard.	The on-board voltage is too low. The battery is too weak or discharged. ► Jump-start the vehicle (▷ page 242). If the engine cannot be jump-started, the starter motor is faulty. ► Consult a qualified specialist workshop.
The engine does not start. The starter motor cannot be heard.	The battery is discharged or faulty. ► Check the battery for damage. ► Charge the battery (▷ page 232).

Automatic transmission

Important safety notes

WARNING

If the engine speed is above the idling speed and you engage transmission position **D** or **R**, the vehicle could pull away suddenly. There is a risk of an accident.

When engaging transmission position **D** or **R**, always firmly depress the brake pedal and do not simultaneously accelerate.

! Vehicles with automatic transmission may roll only briefly in the neutral position **N**. Prolonged rolling of the wheels, e.g. when being towed, will result in transmission damage.

Towing (▷ page 243)

Selector lever

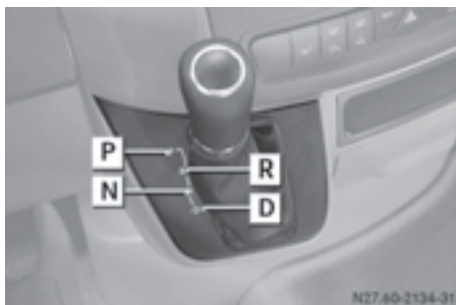

P Park position with parking lock

R Reverse gear

N Neutral

D Drive

The display in the instrument cluster shows the present selector lever position or the current shift range:

- on vehicles with steering wheel buttons (▷ page 167)
- on vehicles without steering wheel buttons (▷ page 163)

Selector lever positions

P

Park position

This prevents the vehicle from rolling away when stopped. Only move the selector lever to **P** if the vehicle is stationary.

You can only remove the key when the selector lever is in this position. The selector lever is locked in position **P** if the key is removed.

The parking lock should not be used as a brake when parking. Always apply the parking brake as well once you have parked the vehicle.

R

Reverse gear

Only move the selector lever to **R** when the vehicle is stationary.

N**Neutral**

No power is transmitted from the engine to the drive wheels. Releasing the brakes will allow you to move the vehicle freely, e.g. by pushing.

Do not move the selector lever to **N** while driving. The automatic transmission could otherwise be damaged.

If ASR is deactivated or ESP® has malfunctioned: only move the selector lever to **N** if the vehicle is in danger of skidding, e.g. on icy roads.

D**Drive**

The automatic transmission changes gear itself. All forward gears are available.

You can influence the gearshifts and shift gears yourself or limit the shift range.

Changing gear

The 5-speed automatic transmission adapts to your individual driving style by continuously adjusting its shift points. These shift point adjustments take into account the current operating and driving conditions. If the operating or driving conditions change, the automatic transmission reacts by adjusting the gearshift program.

When the selector lever is in position **D**, the automatic transmission selects the individual gears automatically. This depends on:

- any restriction in the shift range (> page 125)
- the position of the accelerator pedal
- the road speed

Touchshift

When the selector lever is in position **D**, you can perform gearshifts yourself.

► **To shift down:** press the selector lever to the left towards **D-**.

The automatic transmission shifts to the next gear down, depending on the gear currently engaged. The shift range is also restricted.

i The automatic transmission does not shift down if you press the selector lever towards **D-** while traveling at too high a speed. This protects the engine from overrevving.

► **To shift up:** briefly press the selector lever to the right towards **D+**.

The automatic transmission shifts to the next gear up, depending on the current gearshift program. This also extends the shift range.

► **To derestrict the shift range:** press and hold the selector lever towards **D+** until **D** appears in the display again.

The automatic transmission shifts from the current shift range directly to **D**.

► **To select the optimum shift range:** press and hold the selector lever to the left towards **D-**.

The automatic transmission will shift to a range which allows easy acceleration and deceleration. To do this, the automatic transmission will shift down one or more gears.

Shift ranges

When the selector lever is in position **D** you can restrict or derestrict the shift range for the automatic transmission.

► **To extend and restrict the shift range:**

press the selector lever briefly to the right towards **D+** or left towards **D-**.

The display shows the selected shift range.

The automatic transmission shifts only as far as the relevant gear.

i If the maximum engine speed for the restricted shift range is reached and you depress the accelerator pedal, the automatic transmission will not shift up.

Driving situations

- 2** Use the braking effect of the engine on steep downhill gradients and for driving:
 - on steep mountain roads
 - in mountainous terrain
 - in arduous conditions
- 1** Use the braking effect of the engine on extremely steep downhill gradients and long downhill stretches.

Driving tips

Accelerator pedal position

Your style of driving influences how the automatic transmission shifts gear:

- little throttle: early upshifts
- lots of throttle: later upshifts

Kickdown

Use kickdown for maximum acceleration:

- ▶ Depress the accelerator pedal beyond the pressure point.
The automatic transmission shifts to the next gear down, depending on the engine speed.
- ▶ Ease off on the accelerator pedal once the desired speed is reached.
The automatic transmission shifts up again.

Maneuvering

Maneuvering in a tight space:

- ▶ Control the vehicle's speed by braking carefully.
- ▶ Depress the accelerator pedal slightly and evenly.

i You can shift back and forth between drive position **D** and reverse gear **R** at low speeds without applying the brakes. This can help you, for example when rapidly maneuvering the vehicle or rocking it out of snow or slush.

Towing a trailer

- ▶ Drive at moderate engine speeds on steep uphill gradients.
- ▶ Depending on the uphill or downhill gradient, shift down to a shift range adapted to the driving situation (▷ page 125), even if cruise control is activated.

Problems with the transmission

Problem	Possible causes/consequences and ► Solutions
The transmission malfunctions when shifting gear.	The transmission is losing oil. ► Have the transmission checked immediately at a qualified specialist workshop.
The acceleration characteristics have deteriorated noticeably. The transmission does not shift.	The transmission is in emergency mode. It is only possible to shift into second gear or reverse gear R . ► Stop the vehicle. ► Depress the brake pedal. ► Move the selector lever to position P . ► Switch off the engine. ► Wait at least 10 seconds before restarting the engine. ► Depress the brake pedal. ► Move the selector lever to position D or R . In position D , the transmission shifts into second gear; in position R , the transmission shifts into reverse gear. ► Have the transmission checked immediately at a qualified specialist workshop.

Releasing the parking lock manually

In the event of a malfunction, it is possible to manually release the selector lever from the lock in parking position **P**, e.g. to have the vehicle towed away.



- Apply the parking brake.
- Remove cover ①.
- Slide implement ② as far as it will go into the opening.
- Push the implement in and simultaneously move the selector lever out of position **P**. The selector lever lock is released. You can now move the selector lever freely again until it is returned to position **P**.

- Remove implement ②.
- Re-install cover ①.

i The screwdriver from the vehicle tool kit could function as the implement, for instance (> page 240).

Refueling

Important safety notes

⚠ WARNING

Fuel is highly flammable. Improper handling of fuel creates a risk of fire and explosion.

Avoid fire, open flames, smoking and creating sparks under all circumstances. Switch off the engine and, if applicable, the auxiliary heating before refueling.

⚠ WARNING

Fuel is poisonous and hazardous to health. There is a risk of injury.

You must make sure that fuel does not come into contact with your skin, eyes or clothing

and that it is not swallowed. Do not inhale fuel vapors. Keep fuel away from children.

If you or others come into contact with fuel, observe the following:

- Wash away fuel from skin immediately using soap and water.
- If fuel comes into contact with your eyes, immediately rinse them thoroughly with clean water. Seek medical assistance without delay.
- If fuel is swallowed, seek medical assistance without delay. Do not induce vomiting.
- Immediately change out of clothing which has come into contact with fuel.

WARNING

If you mix diesel fuel with gasoline, the flash point is lower than that of pure diesel fuel. When the engine is running, exhaust system components could overheat without being noticed. There is a risk of fire.

Never refuel with gasoline. Never mix gasoline with diesel fuel.

Environmental note

If fuels are handled improperly, they pose a danger to persons and the environment. Do not allow fuels to run into the sewage system, the surface waters, the ground water or into the ground.

! Do not use gasoline to refuel vehicles with a diesel engine. Even small amounts of gasoline will cause damage to the fuel system and engine.

! Do not switch on the ignition if you accidentally refuel with the wrong fuel. Otherwise, the fuel will enter the fuel lines. Notify a qualified specialist workshop and have the fuel tank and fuel lines drained completely.

! Overfilling the fuel tank could damage the fuel system.

! Take care not to spill any fuel on painted surfaces. You could otherwise damage the paintwork.

! Filter the fuel before transferring it to the vehicle if you are refueling the vehicle from barrels or containers.

This will prevent malfunctions in the fuel system due to contaminated fuel.

Further information on fuel and on fuel grades can be found in the "Technical data" section (> page 277).

Refueling procedure

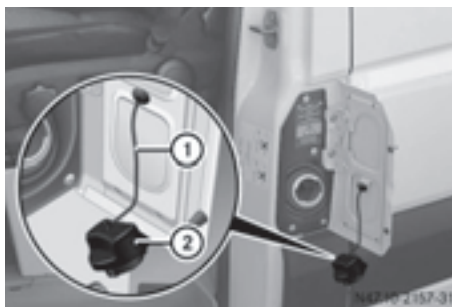

The fuel filler flap is beside the front left-hand door when viewed in the direction of travel. It is only possible to open the fuel filler flap when the front door is open.



- ▶ Remove the key from the ignition lock.
 - ▶ Switch off the auxiliary heating system (> page 106).
 - ▶ Open the front left-hand door first, and then the fuel filler flap.
 - ▶ Close all vehicle doors to prevent fuel vapors from entering the vehicle interior.
 - ▶ Turn fuel filler cap (2) counter-clockwise, remove it and let it hang from strap (1).
 - ▶ Completely insert the filler neck of the fuel pump nozzle into the tank and refuel.
 - ▶ Only fill the tank until the pump nozzle switches off. Fuel may otherwise leak out.
 - ▶ Replace tank filler cap (2) on tank and turn clockwise.
- You will hear a click when the fuel filler cap is closed fully.
- ▶ Open the front left-hand door first, and then close the filler flap.

Problems with the fuel and fuel tank

If your vehicle is losing fuel, the fuel lines or the fuel tank are defective.

- ▶ Turn the key immediately to position **0** in the ignition lock and remove it.
- ▶ Do not restart the engine under any circumstances.
- ▶ Consult a qualified specialist workshop.

If the fuel tank has been run dry, after refueling carry out the following steps:

- ▶ Before starting the engine: switch on the ignition three or four times.
- ▶ Turn the key to position **2** in the ignition lock (▷ page 119).
The  preglow indicator lamp in the instrument cluster lights up briefly.
- ▶ Once the  preglow indicator lamp goes out, turn the key to position **3** in the ignition lock and release it as soon as the engine is running.

You can start the diesel engine without preglow when the engine is warm.

Diesel Exhaust Fluid (DEF)

Important safety notes

- ! Only use DEF in accordance with ISO 22241. Never mix DEF with additives or thin it with tap water. The exhaust gas after-treatment may otherwise be damaged.
Observe the MB Specifications for Service Products, Sheet 352.0.
Damage that results from the use of additives or tap water leads to the loss of the New Vehicle Limited Warranty.
- ! If DEF comes into contact with a painted or aluminum surface, wash the surface off immediately with plenty of water.
- ! DEF is not a diesel additive and must not be mixed with fuel in the tank. Even small amounts of DEF can cause engine damage.
Damage that results from the blending of DEF will not be covered by the New Vehicle Limited Warranty.
- i If the outside temperature is below 12 °F (-11 °C) it may be difficult to top up. If the DEF is frozen and there is an active warning indi-

cator, topping up may not be possible. Park the vehicle in a warm place, e.g. in a garage, until the DEF has become liquid again. Topping up is then possible again. Alternatively, have the DEF tank refilled at a qualified specialist workshop.

- i If you add DEF at temperatures below 12 °F (-11 °C) it is possible that the level is not shown correctly due to the frozen DEF.

Drive for at least 20 minutes (heating phase in the tank activated) and then stop the vehicle for at least 30 seconds. The level is then shown correctly.

You will find further information on DEF in the "Service products" section (▷ page 277).



Refueling procedure

DEF filler neck

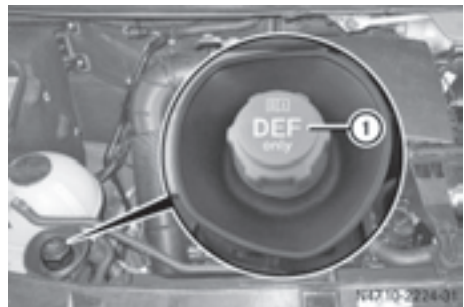
Non-lockable DEF filler cap



Example: DEF filler cap in the engine compartment

- ▶ **To open:** switch off the ignition.
- ▶ Open the hood (▷ page 218).
- ▶ Turn filler cap  counter-clockwise and remove it.
- ▶ **To close:** replace cap  on the filler neck and turn it clockwise.
You will hear a click when cap  is fully closed.
- ▶ Close the hood (▷ page 219).

Lockable filler cap

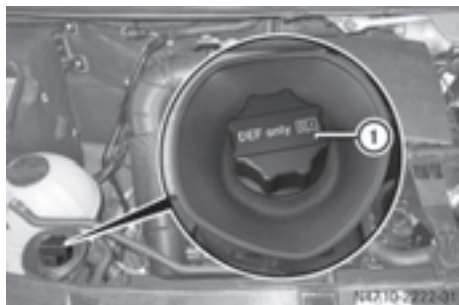

Example: DEF filler cap in the engine compartment

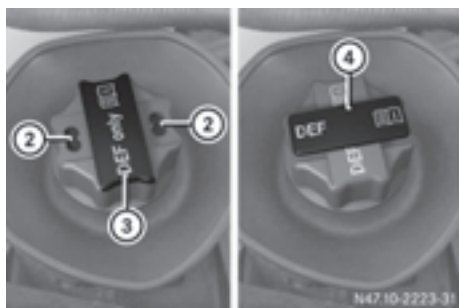

- ▶ **To open:** switch off the ignition.
- ▶ Open the hood (▷ page 218).
- ▶ Remove tool ④ for unlocking tank filler cap ① from the footwell on the front-passenger side (▷ page 240).
- ▶ Pull cover ③ up, turn 90° and release.
- ▶ Insert tool ④ into hole ② of tank filler cap ①.
- ▶ Turn filler cap ① counter-clockwise and remove it. Make sure that tool ④ remains in tank filler cap ① while doing so.
- ▶ **To close:** replace filler cap ① and turn it clockwise until closed.
- ▶ Pull tool ④ out of tank filler cap ① and stow with the vehicle tool kit in the footwell on the front-passenger side.
- ▶ Pull cover ③ up over hole ② of tank filler cap ①, turn and release.
- ▶ Turn tank filler cap ①.
 - ▶ If tank filler cap ① turns freely, the DEF tank is closed.

Parking

Important safety notes

⚠ WARNING

Flammable material such as leaves, grass or twigs may ignite if they come into contact with hot parts of the exhaust system or exhaust gas flow. There is a risk of fire.

Park the vehicle so that no flammable materials come into contact with parts of the vehicle which are hot. Take particular care not to park on dry grassland or harvested grain fields.

⚠ WARNING

If you switch off the ignition while driving, safety-relevant functions are only available with limitations, or not at all. This could affect, for example, the power steering and the brake boosting effect. You will require considerably more effort to steer and brake. There is a risk of an accident.

Do not switch off the ignition while driving.

⚠ WARNING

If you leave children unsupervised in the vehicle, they could set it in motion by, for example:

- release the parking brake.
- shift the automatic transmission out of the parking position **P**.
- start the engine.

In addition, they may operate vehicle equipment and become trapped. There is a risk of an accident and injury.

When leaving the vehicle, always take the SmartKey with you and lock the vehicle. Never leave children unsupervised in the vehicle.

⚠ A moving vehicle can lead to damage to the vehicle or damage to the drive train.

⚠ When the vehicle is parked, always remove the key to prevent the battery from becoming discharged.

On vehicles with a battery isolating switch, switch off the power supply if the vehicle is to be out of use for a longer period of time.

Always park your vehicle safely and according to legal requirements and secure it against rolling away.

To ensure that the vehicle is properly secured against rolling away unintentionally:

- the parking brake must be firmly applied
- the selector lever must be in position **P** and the key must be removed from the ignition lock
- on steep uphill or downhill gradients, the front wheels must be turned towards the curb
- the rear axle must be secured, e.g. with a wheel chock, on steep uphill or downhill gradients

Use the wheel chock (▷ page 132) to do so.

If you leave the vehicle parked for more than three weeks:

- connect the batteries to a trickle charger or
- disconnect the vehicle's starter battery or
- switch off the electrical system using the battery main switch (▷ page 118) and
- disconnect the vehicle's auxiliary battery

Otherwise, you need to check the battery's condition of charge every three weeks, since standby power consumption can drain the battery. If the battery voltage is lower than 12.2 V, the battery must be charged. Otherwise, the battery may be damaged by exhaustive discharging.

Be sure to observe the notes on disconnecting and charging the batteries under "Battery" (▷ page 227). You can obtain information about trickle chargers from a qualified specialist workshop.

Parking brake

WARNING

If you leave children unsupervised in the vehicle, they could set it in motion by, for example:

- release the parking brake.
- shift the automatic transmission out of the parking position **P**.
- start the engine.

In addition, they may operate vehicle equipment and become trapped. There is a risk of an accident and injury.

When leaving the vehicle, always take the SmartKey with you and lock the vehicle. Never leave children unsupervised in the vehicle.

WARNING

If you must brake the vehicle with the parking brake, the braking distance is considerably longer and the wheels could lock. There is an increased danger of skidding and accidents.

Only use the parking brake to brake the vehicle when the service brake is faulty. Do not apply the parking brake too firmly. If the wheels lock, release the parking brake until the wheels begin turning again.

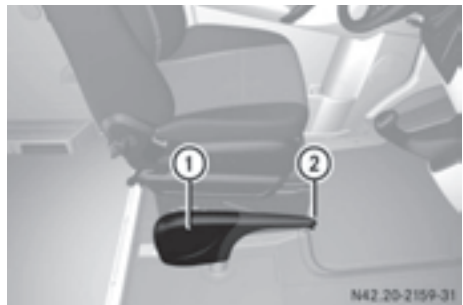

The brake lamps are not illuminated when you brake the vehicle using the parking brake.

As a rule, you may only apply the parking brake when the vehicle is stationary.

- ▶ **To apply the parking brake:** pull brake lever ① up as far as the last possible detent. The  warning lamp in the instrument cluster lights up if the engine is running.

 On vehicles with a folding brake lever, you can then press lever ① down to the stop.

- ▶ **To release the parking brake:** on vehicles with a folding brake lever, first pull brake lever ① up to the stop.
- ▶ Raise brake lever ① slightly and press release knob ②.
- ▶ Guide brake lever ① down to the stop. The  indicator lamp in the instrument cluster goes out.

Exceptionally, if the service brake fails, the parking brake can be used to brake the vehicle in an emergency.

- ▶ **Emergency braking:** press and hold release button ② and carefully apply brake lever ①.

Switching off the engine

WARNING

The automatic transmission switches to neutral position **N** when you switch off the engine. The vehicle may roll away. There is a risk of an accident.

After switching off the engine, always switch to parking position **P**. Prevent the parked vehicle from rolling away by applying the parking brake.

- ❗ If the coolant temperature is very high, e.g. after driving on hilly roads, leave the engine running at idle speed for about two minutes before turning it off.

This allows the coolant temperature to return to normal.

- ▶ Stop the vehicle.
- ▶ Shift the automatic transmission to position **P**.
- ▶ Apply the parking brake.
- ▶ Turn the key to position **0** in the ignition lock and remove it.
The immobilizer is activated.
- ▶ Secure the vehicle to prevent it from rolling away (▷ page 130).

Wheel chock

Use the wheel chock or a similar object to prevent the vehicle from rolling away, e.g. when parking or changing a wheel.

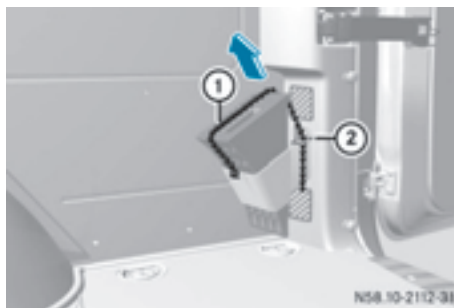

Wheel chock in the load/passenger compartment

- ▶ **To remove the wheel chock on Cargo Vans/Passenger Vans:** pull restraining cable ① down a little and remove it from retainer ②.
- ▶ Remove the chock.

- ❗ When stowing the wheel chock, make sure that restraining cable ① is holding it securely in retainer ②.

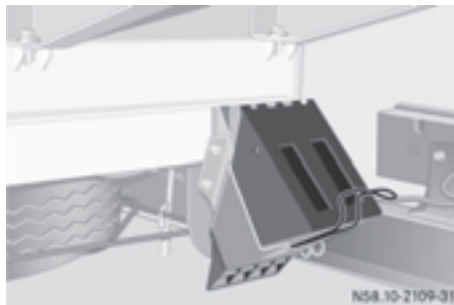

Wheel chock to the rear of the chassis on the left side of the vehicle (example)

- ▶ **To remove the wheel chock on Cab Chassis:** pull the locking springs down and remove the wheel chock.
- ❗ When stowing the wheel chock, make sure that it is secured in the retainer with the locking springs.

Parking the vehicle for a long period

If you park your vehicle for longer than three weeks:

- connect the batteries to a trickle charger or
- disconnect the vehicle's starter battery or

- switch off the electrical system using the battery main switch (▷ page 118) and
- disconnect the vehicle's auxiliary battery

Otherwise, you need to check the battery's condition of charge every three weeks, since standby power consumption can drain the battery. If the battery voltage is lower than 12.2 V, the battery must be charged. Otherwise, the battery may be damaged by exhaustive discharging.

Be sure to observe the notes on disconnecting and charging the batteries under "Battery" (▷ page 227). You can obtain information about trickle chargers from a qualified specialist workshop.

If you leave the vehicle parked for longer than 6 weeks, the vehicle may suffer damage as a result of lack of use. In this event, consult a qualified specialist workshop.

Driving tips

General notes

Important safety notes

WARNING

The driver's attention to the road must always be his/her primary focus when driving. For your safety and the safety of others, we recommend that you pull over to a safe location and stop before placing or taking a telephone call. If you choose to use the telephone while driving, please use the hands-free device and only use the telephone when road, weather and traffic conditions permit.

Some jurisdictions prohibit the driver from using a mobile phone while driving a vehicle.

Bear in mind that at a speed of just 30 mph (approximately 50 km/h), your vehicle covers a distance of 44 feet (approximately 14 m) every second.

WARNING

If you switch off the ignition while driving, safety-relevant functions are only available with limitations, or not at all. This could affect, for example, the power steering and the brake boosting effect. You will require considerably

more effort to steer and brake. There is a risk of an accident.

Do not switch off the ignition while driving.

- ! Always observe the ground clearance of the vehicle and avoid obstacles. On vehicles with a step, ground clearance is further restricted. Obstacles can damage the vehicle.

If you must drive over obstacles, drive especially slowly and carefully. If necessary, have another person direct you.

Drive sensibly – save fuel

In order to save fuel, observe the following tips:

- ▶ The tires should always be inflated to the recommended tire pressure.
- ▶ Remove unnecessary loads.
- ▶ Remove roof carriers when they are not needed.
- ▶ Warm up the engine at low engine speeds.
- ▶ Avoid frequent acceleration or braking.
- ▶ Have all maintenance work carried out as indicated by the service intervals in the Maintenance Booklet or by the service interval display.

Fuel consumption also increases when driving in cold weather, in stop-start traffic and in mountainous terrain.

Overrun cutoff

If you are in overrun mode and take your foot off the accelerator pedal, the fuel supply is cut off when the engine speed is out of the idle speed control range.

Drinking and driving

WARNING

Drinking and driving and/or taking drugs and driving are very dangerous combinations. Even a small amount of alcohol or drugs can affect your reflexes, perceptions and judgment.

The possibility of a serious or even fatal accident are greatly increased when you drink or take drugs and drive.

Do not drink or take drugs and drive or allow anyone to drive who has been drinking or taking drugs.

Emission control

WARNING

Combustion engines emit poisonous exhaust gases such as carbon monoxide. Inhaling these exhaust gases leads to poisoning. There is a risk of fatal injury. Therefore never leave the engine running in enclosed spaces without sufficient ventilation.

Certain engine systems are designed to keep the level of poisonous substances in exhaust fumes within legal limits.

These systems only work optimally if they are maintained exactly in accordance with the manufacturer's specifications. Any work on the engine should therefore be carried out by qualified and authorized technicians at a Sprinter dealer.

The engine settings must not be changed under any circumstances. In addition, all specific maintenance work must be carried out at regular intervals and in accordance with the service requirements of the dealer listed here on the inside title page. Details can be found in the Maintenance Booklet.

Short journey

! If the vehicle is predominantly used for short-distance driving or is stationary for long periods, this could lead to a malfunction in the automatic cleaning function for the diesel particle filter. This can lead to blockage of the diesel particle filter. This can also result in fuel collecting in the engine oil and cause engine failure.

Therefore, if you mainly drive short distances, drive on a highway or an inter-urban road for 20 minutes every 300 miles (500 km). This facilitates the diesel particle filter's burn-off process.

Speed limiter

WARNING

Exceeding the stated tire load-bearing capacity and the approved maximum speed could lead to tire damage or the tire bursting. There is a risk of accident.

Therefore, only use tire types and sizes approved for your vehicle model. Observe the tire load rating and speed rating required for your vehicle.

As the driver, you must find out about the maximum speed of the vehicle and the resulting permissible maximum speed of the tires (tire and tire pressure). In particular, also observe the tire approval regulations for each country.

You must not exceed the speed limit for the tires listed in the tire pressure tables. You can find information on tire pressures in the "Wheels and tires" section (▷ page 250).

You can permanently limit the maximum speed of your vehicle to 65 mph (105 km/h) or 75 mph (120 km/h).

We recommend that you have the maximum speed programmed by an authorized Sprinter dealer.

Before overtaking, take into consideration that the engine speed limiter prevents the speed increasing beyond the programmed maximum speed.

Driving abroad

Service

An extensive network of authorized Sprinter Dealers is also at your disposal when you are traveling abroad. Nevertheless, please bear in mind that service facilities or replacement parts may not always be immediately available. You can obtain a list of workshops at any authorized Sprinter Dealer.

Fuel

In some countries, only fuels with a higher sulfur content are available.

Unsuitable fuel can cause engine damage. Information on fuel (▷ page 277).

Low-beam headlamps

If you are traveling in countries where vehicles are driven on the opposite side of the road to that in which the vehicle is registered, you will need to:

- have the halogen headlamps partially masked
- have the Bi-Xenon headlamps set to symmetrical low beam

This prevents glare to oncoming traffic and no longer illuminates the edge of the road to the same height and distance.

Have the headlamps masked or adjusted at a qualified specialist workshop before you cross the border, but as close to it as possible.

When you return from your journey, and as close to the border as possible, you will need to:

- remove the adhesive surfaces from your halogen headlamps and clean the glass of the headlamps if necessary
- have the Bi-Xenon headlamps reset to asymmetrical low beam at a qualified specialist workshop

Transport by rail

Transporting your vehicle by rail may be subject to certain restrictions or require special measures to be taken in some countries due to varying tunnel heights and loading standards.

You can obtain further information from any authorized Sprinter dealer.

Brakes

Important safety notes

WARNING

If you shift down on a slippery road surface in an attempt to increase the engine's braking effect, the drive wheels could lose their grip. There is an increased danger of skidding and accidents.

Do not shift down for additional engine braking on a slippery road surface.

WARNING

If you rest your foot on the brake pedal while driving, the braking system can overheat. This

increases the stopping distance and can even cause the braking system to fail. There is a risk of an accident.

Never use the brake pedal as a footrest. Never depress the brake pedal and the accelerator pedal at the same time.

- ! Depressing the brake pedal constantly results in excessive and premature wear to the brake pads.

Downhill gradients

- ! Depressing the brake pedal constantly results in excessive and premature wear to the brake pads.

On long and steep downhill gradients, you should change down to shift range **2** or **1** in good time. This should be observed in particular when driving with a laden vehicle and when towing a trailer.

- i You must also change the shift range in good time when cruise control is switched on.

You thereby make use of the braking effect of the engine and do not have to brake as often to maintain the speed. This relieves the load on the service brake and prevents the brakes from overheating and wearing too quickly.

Heavy and light loads

WARNING

If you rest your foot on the brake pedal while driving, the braking system can overheat. This increases the stopping distance and can even cause the braking system to fail. There is a risk of an accident.

Never use the brake pedal as a footrest. Never depress the brake pedal and the accelerator pedal at the same time.

- ! Depressing the brake pedal constantly results in excessive and premature wear to the brake pads.

If the brakes have been subjected to a heavy load, do not stop the vehicle immediately. Drive on for a short while. The brakes are cooled down more quickly in the airflow.

Wet road surfaces

If you have been driving for a long time in heavy rain without braking, there may be a delayed response when you first apply the brakes. This may also occur after driving through a car wash or deep water.

You must depress the brake pedal more firmly. Maintain a longer distance to the vehicle in front.

While paying attention to the traffic conditions, you should brake the vehicle firmly after driving on a wet road surface or through a car wash. This heats the brake discs, so that they dry more quickly, which protects them against corrosion.

Limited braking performance on salt-treated roads

When driving on salted roads, salt may start to build up on the brake disks and brake pads. This can increase braking distances considerably. Maintain a greater distance to the vehicle in front.

To remove any build-up of salt that may have formed:

- ▶ Apply the brakes at the start of the journey, occasionally during journey and at the end of the journey. Make sure that you do not endanger other road users when doing so.

New brake discs and brake pads/linings

New brake pads and brake discs only reach their optimal braking effect after a few 100 kilometers. Until then, compensate for this by applying greater force to the brake pedal.

For safety reasons, Mercedes-Benz recommends only installing the following brake discs and brake pads/linings:

- brake discs that have been approved by Mercedes-Benz
- brake pads/linings that have been approved by Mercedes-Benz or are of an equivalent standard of quality

Other brake discs or brake pads/linings can compromise the safety of your vehicle.

Always replace all brake discs and brake pads/linings on an axle at the same time. Always install new brake pads/linings when replacing brake discs.

Parking brake

WARNING

If you must brake the vehicle with the parking brake, the braking distance is considerably longer and the wheels could lock. There is an increased danger of skidding and accidents.

Only use the parking brake to brake the vehicle when the service brake is faulty. Do not apply the parking brake too firmly. If the wheels lock, release the parking brake until the wheels begin turning again.

When driving on wet roads or dirt-covered surfaces, road salt and/or dirt may get into the parking brake. This causes corrosion and a reduction of braking force.

In order to prevent this, drive with the parking brake lightly applied from time to time. When doing so, drive for a distance of approximately 110 yds (100 m) at a maximum speed of 12 mph (20 km/h).

The brake lamps are not illuminated when you brake the vehicle using the parking brake.

Driving in wet conditions

Hydroplaning

WARNING

There is a danger of hydroplaning occurring, even if you are driving slowly and your tires have sufficient tread depth, depending on the depth of water on the road. There is a risk of an accident.

For this reason, avoid tire ruts and brake carefully.

Therefore, in heavy rain or other conditions in which hydroplaning can occur, drive as follows:

- reduce your speed
- avoid tire ruts
- apply the brakes with care

Driving on flooded roads

- ❗ Do not drive through flooded areas. Check the depth of any water before driving through it. Drive slowly through standing water. Oth-

erwise, water may enter the vehicle interior or the engine compartment. This can damage the electronic components in the engine or the automatic transmission. Water can also be drawn in by the engine's air suction nozzles and this can cause engine damage.

If you have to drive on stretches of road on which water has collected, please bear in mind that:

- the water level of standing water should not be above the lower edge of the front bumper
- do not drive faster than walking speed

Driving in winter

General notes

WARNING

If you shift down on a slippery road surface in an attempt to increase the engine's braking effect, the drive wheels could lose their grip. There is an increased danger of skidding and accidents.

Do not shift down for additional engine braking on a slippery road surface.

DANGER

If the exhaust pipe is blocked or adequate ventilation is not possible, poisonous gases such as carbon monoxide (CO) may enter the vehicle. This is the case, e.g. if the vehicle becomes trapped in snow. There is a risk of fatal injury.

If you leave the engine or the auxiliary heating running, make sure the exhaust pipe and area around the vehicle are clear of snow. To ensure an adequate supply of fresh air, open a window on the side of the vehicle that is not facing into the wind.

Have your vehicle winterproofed at a qualified specialist workshop in good time at the onset of winter.

-  Do not cover the radiator, e.g. with a winter cover. The measurements of the on-board diagnostic system may otherwise return inaccurate values. Some of these values are legally prescribed and must therefore always be exact.

Observe the notes in the "Winter operation" section (▷ page 249).

Slippery road surfaces

WARNING

If you shift down on a slippery road surface in an attempt to increase the engine's braking effect, the drive wheels could lose their grip. There is an increased danger of skidding and accidents.

Do not shift down for additional engine braking on a slippery road surface.

WARNING

The outside temperature indicator is not designed to serve as an ice-warning device and is therefore unsuitable for that purpose. Indicated temperatures just above the freezing point do not guarantee that the road surface is free of ice. The road may still be icy, especially in wooded areas or on bridges.

-  Vehicles with automatic transmission may roll only briefly in the neutral position **N**. Prolonged rolling of the wheels, e.g. when being towed, will result in transmission damage.

If the vehicle threatens to skid or cannot be stopped when moving at low speed:

- ▶ Shift the transmission to neutral position **N**.
- ▶ Try to maintain control of the vehicle using corrective steering.

Drive particularly carefully on slippery roads. Avoid sudden acceleration, steering and braking maneuvers. Do not use cruise control.

You can find further information on winter tires and snow chains in the "Winter operation" section (▷ page 249).

Driving off-road

Important safety notes

WARNING

If you drive on a steep incline at an angle or turn when driving on an incline, the vehicle

could slip sideways, tip and rollover. There is a risk of an accident.

Always drive on a steep incline in the line of fall (straight up or down) and do not turn the vehicle.

WARNING

When driving off-road, your body is subject to forces from all directions, due to the uneven surface. You could be thrown from your seat, for instance. There is a risk of injury.

Always wear a seat belt, even when driving off-road.

WARNING

If you drive over obstacles or in ruts, the steering wheel may jerk out of your grip, causing injury to your hands.

Always hold the steering wheel firmly with both hands. When driving over obstacles, you must expect steering forces to increase briefly and suddenly.

WARNING

Flammable material such as leaves, grass or twigs may ignite if they come into contact with hot parts of the exhaust system. There is a risk of fire.

When driving off road or on unpaved roads, check the vehicle's underside regularly. In particular, remove parts of plants or other flammable materials which have become trapped. In the case of damage, contact a qualified specialist workshop.

- !** When driving off-road or on unpaved surfaces, check the underside of the vehicle and the wheels and tires at regular intervals. In particular, remove any trapped foreign objects, e.g. stones and branches.

Such foreign objects may:

- damage the chassis, the fuel tank or the brake system
- cause imbalances and thus vibrations
- be flung out when you continue driving

If there is any damage, inform a qualified specialist workshop.

When driving off-road and on construction sites, sand, mud and water mixed with oil, for example, may get into the brakes. This may lead to a reduction in braking performance or total brake failure, also as a result of increased wear. The braking characteristics will vary depending on the material that has got into the system. Clean the brakes after driving off-road. If you then notice reduced braking performance or hear scraping noises, have the brake system checked at a qualified specialist workshop. Adjust your driving style to the changed braking characteristics.

Driving off-road or on construction sites increases the possibility of vehicle damage which may in turn lead to the failure of certain assemblies and systems. Adapt your driving style to the off-road driving conditions. Drive carefully. Have any vehicle damage rectified at a qualified specialist workshop as soon as possible.

When driving on rough terrain, do not shift the transmission into the neutral position. You could lose control when attempting to brake the vehicle with the service brake. If your vehicle cannot manage an uphill slope, drive back down the slope in reverse gear.

When loading your vehicle for driving off-road or on a construction site, keep the vehicle's center of gravity as low as possible.

Checklist before driving off-road

- ▶ Check the fuel and DEF levels (▷ page 162) and top up (▷ page 129).
- ▶ **Engine:** check the oil level (▷ page 220) and add oil (▷ page 222).
Before driving up or down steep gradients, fill the oil to the maximum level.
- i** If you drive up or down steep gradients, the  symbol may appear in the display. The engine operating safety is not put at risk if you have filled the engine oil to the maximum level before the journey.
- ▶ **Vehicle tool kit:** check that the jack is working (▷ page 240).
- ▶ Make sure that a lug wrench (▷ page 240), wooden underlay for the jack, a robust tow cable and a folding spade are carried in the vehicle.
- ▶ **Wheels and tires:** check the tire tread depth (▷ page 248) and tire pressure (▷ page 250).

Rules for driving off-road

! Always bear the vehicle's ground clearance in mind and avoid obstacles, e.g. deep ruts. Obstacles may damage the following parts of the vehicle:

- the chassis
- the drive train
- the fuel and supply tanks

For this reason, you should always drive slowly when driving off-road. If you have to drive over obstacles, have the front passenger direct you.

i We recommend that you additionally carry a shovel and a recovery rope with shackle in the vehicle.

- Ensure that loads and items of luggage are securely stowed or lashed down (▷ page 212).
- Before driving off-road, stop the vehicle and shift to a low gear.
- If the surface demands it, temporarily deactivate ASR when pulling away (▷ page 53).
- Only drive off-road with the engine running and a gear engaged.
- Drive slowly and smoothly. Walking pace is necessary in many situations.
- Avoid spinning the drive wheels.
- Make sure that the wheels always remain in contact with the ground.
- Drive with extreme care over unknown terrain where you can only see for a short distance. As a precaution, get out of the vehicle to take a look at the route to be taken in advance.
- Check the water depth before fording.
- Watch out for obstacles (e.g. rocks, holes, tree stumps and ruts).
- Avoid edges where the surface could crumble or break away.

Checklist after driving off-road

! If you detect damage to the vehicle after driving off-road, have the vehicle checked immediately at a qualified specialist workshop.

Off-road driving places a higher demand on your vehicle than normal road operation. Check your vehicle after driving on rough terrain. By doing so you will notice any damage in good time and

reduce the risk of an accident for yourself and other road users. Clean your vehicle thoroughly before driving on public roads.

Observe the following points after driving off-road, on construction sites and before driving on public roads:

- ▶ **Vehicles with all-wheel drive:** deactivate all-wheel drive (▷ page 148).
- ▶ Activate ASR (▷ page 53).
- ▶ Clean the headlamps and tail lamps and check them for damage.
- ▶ Clean the front and rear license plates.
- ▶ Clean the windshield, windows and exterior mirrors.
- ▶ Clean the steps, door sills and grab handles. This increases safety of footing.
- ▶ Clean the wheels and tires, wheel arches and the underbody of the vehicle with a water jet. This increases road grip, especially on wet road surfaces.
- ▶ Check the wheels and tires and wheel arches for trapped foreign objects and remove them. Trapped foreign objects can damage the wheels and tires or may be flung out from the vehicle when you continue driving.
- ▶ Check the underbody for trapped branches or other parts of plants and remove them. Trapped branches or other parts of plants increase the risk of fire and can cause damage to fuel lines, brake hoses and the rubber bellows of axle joints and drive shafts.
- ▶ Clean the brake disks, brake pads and axle joints, particularly after operation in sand, mud, grit and gravel, water or similarly dirty conditions.
- ▶ Check the entire floor assembly, the tires, wheels, bodywork structure, brakes, steering, chassis and exhaust system for any damage.
- ▶ Check the service brake for operating safety, e.g. carry out a brake test.
- ▶ If you notice strong vibrations after driving off-road, check the wheels and drive train for foreign objects again. Remove any foreign objects which can lead to imbalances and thus cause vibrations.

Driving systems

Cruise control

General notes

Cruise control maintains the speed of the vehicle for you.

Use cruise control if road and traffic conditions make it appropriate to maintain a steady speed for a prolonged period. You can set any speed from 20 mph upwards in increments of 1 mph.

- i** If you have set km/h as the unit for the digital speedometer (> page 170), you can set any speed from 30 km/h upwards in increments of 1 km/h.

Cruise control should not be activated when driving off-road or on construction sites.

Cruise control may not be able to maintain the stored speed on uphill or downhill gradients. If the gradient evens out and the vehicle's speed does not fall below 20 mph (30 km/h), the stored speed is resumed.

- i** The speed shown in the speedometer may differ slightly from the speed stored by cruise control.

Important safety notes

If you fail to adapt your driving style or if you are inattentive, cruise control can neither reduce the risk of an accident nor override the laws of physics. Cruise control cannot take road, weather and traffic conditions into account. Cruise control is only an aid. You are responsible for the distance to the vehicle in front, for vehicle speed, for braking in good time and for staying in lane.

Do not use cruise control:

- in traffic conditions that are unsuitable for driving at a constant speed, e.g. in heavy traffic, on winding roads or off-road.
- on slippery roads. Braking or accelerating may cause the drive wheels to lose traction and the vehicle could then skid.
- when there is poor visibility, e.g. due to fog, heavy rain or snow.

If there is a change of drivers, make sure that you inform the new driver about the set cruise speed.

Cruise control lever

Operating cruise control



- ① To activate and store the current speed or a higher speed
- ② To activate at the last stored speed
- ③ To activate and store the current speed or a lower speed
- ④ To deactivate cruise control

The cruise control lever is the upper lever on the left of the steering column.

Displaying the cruise control speed

Vehicles with steering wheel buttons: when you activate cruise control, the text field in the display briefly shows the **speed limit** message and the stored speed. The status area of the display then shows the  symbol and the stored speed.

Vehicles without steering wheel buttons: when you activate cruise control, the display briefly shows the  symbol and the stored speed.

Activation conditions

To activate cruise control, all of the following activation conditions must be fulfilled:

- the parking brake must be released. The  indicator lamp in the instrument cluster is off
- you are driving faster than 20 mph (30 km/h)
- neither the brake or clutch pedal is depressed

- i** Other drive and brake systems not described in this Operator's Manual, such as a retarder, may affect cruise control. You can find information on this in the separate operating instructions provided by the body manufacturer.

Storing and maintaining the current speed

- ▶ Accelerate the vehicle to the desired speed above 20 mph (30 km/h).
- ▶ Briefly push the cruise control lever up ① or down ④.
- ▶ Release the accelerator pedal. Cruise control is activated. The current speed is stored.
The display shows the  symbol and the stored speed.

Resuming the stored speed

WARNING

If you call up the stored speed and it differs from the current speed, the vehicle accelerates or decelerates. If you do not know the stored speed, the vehicle could accelerate or brake unexpectedly. There is a risk of an accident.

Pay attention to the road and traffic conditions before calling up the stored speed. If you do not know the stored speed, store the desired speed again.

- ▶ Briefly pull the cruise control lever towards you ③.
- ▶ Release the accelerator pedal. Cruise control is activated and resumes the vehicle's speed to the last speed stored.
The display shows the  symbol and the stored speed.
- i** When you pull the cruise control lever towards you for the first time after starting the engine, cruise control adopts the current speed.

Setting the speed

It may be a moment before the vehicle starts to accelerate or brake to the set speed. Take this delay into account when setting the speed.

- ▶ Briefly push the cruise control lever up ① to increase the speed or down ③ to reduce the speed.
The last stored speed increases or decreases in 1 mph increments (1 km/h increments).
- or
- ▶ Press and hold the cruise control lever up ① or down ③ until the desired speed has been reached.
- ▶ Release the cruise control lever.
The current speed is stored.
The display shows the  symbol and the stored speed.

- i** Cruise control is not deactivated if you depress the accelerator pedal. If you accelerate briefly to overtake, for example, cruise control resumes the vehicle's speed to the last speed stored after you have finished overtaking.

Deactivating cruise control

There are various ways to deactivate cruise control:

- ▶ Briefly press the cruise control lever forwards ④.
- or
- ▶ Apply the brakes.

The last speed set remains stored. The last speed stored is deleted when you switch off the engine.

Cruise control is deactivated automatically when:

- you apply the brakes
- you apply the parking brake and the  indicator lamp in the instrument cluster lights up
- you are driving slower than 20 mph (30 km/h)
- you shift the automatic transmission to neutral position **N** while the vehicle is in motion
- ESP[®] or ASR intervenes
- there is a malfunction in the ESP[®], ASR or ABS system

Problems with cruise control

Problem	Possible causes/consequences and ► Solutions
On vehicles with steering wheel buttons, the speed cannot be set when cruise control is activated.	<p>The display shows a high-priority message. Thus a change in speed is not possible.</p> <ul style="list-style-type: none"> ► Proceed as instructed by the message in the display. ► Deactivate cruise control

COLLISION PREVENTION ASSIST

General notes

COLLISION PREVENTION ASSIST comprises the distance warning function and adaptive Brake Assist.

Distance warning function

Important safety notes

i Note the section on 'Important safety notes' (► page 52).

WARNING

The distance warning function does not react:

- to people or animals
- to oncoming vehicles
- to crossing traffic
- when cornering

Thus, the distance warning function cannot provide a warning in all critical situations.

There is a risk of an accident.

Always pay careful attention to the traffic situation and be ready to brake.

WARNING

The distance warning function cannot always clearly identify objects and complex traffic situations.

In such cases, the distance warning function may:

- give an unnecessary warning
- not give a warning

There is a risk of an accident.

Always pay careful attention to the traffic situation and do not rely solely on the distance warning function.

Operation

The distance warning function can help you to minimize the risk of a front-end collision with a vehicle ahead or reduce the effects of such a collision. If the distance warning function detects that there is a risk of a collision, you will be warned visually and acoustically. Without your intervention, the distance warning function cannot prevent a collision.

The distance warning function will issue a warning at speeds of around 20 mph (30 km/h) or more if:

- you approach a vehicle ahead of you very quickly. You will then hear an intermittent warning tone and the red  warning lamp in the instrument cluster flashes.

► Brake immediately in order to increase the distance from the vehicle in front.

or

► Take evasive action provided it is safe to do so.

If you want the distance warning function to assist you, the function must be activated and operational.

Due to the nature of the system, particularly complicated driving conditions may cause the system to display an unnecessary warning.

With the help of the radar sensor system, the distance warning function can detect obstacles that are in the path of your vehicle for an extended period of time.

Up to a speed of around 45 mph (70 km/h), the distance warning function can also react to stationary obstacles, such as stopped or parked vehicles.

If you approach an obstacle and the distance warning function detects a risk of a collision, the system will alert you both visually and acoustically.

In particular, the detection of obstacles can be impaired in the case of:



- dirt on the sensors or anything else covering the sensors
- snow or heavy rain
- interference from other radar sources
- there are strong radar reflections, for example in parking garages
- a narrow vehicle traveling in front, e.g. a motorbike
- a vehicle traveling in front on a different line



Following damage to the front end of the vehicle, have the configuration and operation of the radar sensor checked at a qualified specialist workshop. This also applies to collisions at slow speeds where there is no visible damage to the front of the vehicle.

Activating/deactivating the distance warning function



When you switch on the engine, the distance warning function switches on after a few seconds.

► **To deactivate:** press the  button (▷ page 35).

Vehicles without steering wheel buttons: the  warning lamp in the instrument cluster lights up and the **OFF** message flashes. The message then disappears and the  indicator lamp remains lit.

Vehicles with steering wheel buttons: the  warning lamp in the instrument cluster flashes and the **Distance warning system deactivated** message appears. The message then disappears and the  warning lamp remains lit.

► **To activate:** press the  button again (▷ page 35).

Vehicles without steering wheel buttons: the  warning lamp in the instrument cluster lights up and the **on** message flashes. The message then disappears and the  indicator lamp goes out.

Vehicles with steering wheel buttons: the  warning lamp in the instrument cluster flashes and the **Distance warning system activated** message appears in the multi-

function display. The message then disappears and the indicator lamp  goes out.

Adaptive Brake Assist

i Observe the "Important safety notes" section for driving safety systems (▷ page 52).

WARNING

Adaptive Brake Assist cannot always clearly identify objects and complex traffic situations.

In such cases, Adaptive Brake Assist can:

- intervene unnecessarily
- not intervene

There is a risk of an accident.

Always pay careful attention to the traffic situation and be ready to brake. Terminate the intervention in a non-critical driving situation.

WARNING

Adaptive Brake Assist does not react:

- to people or animals
- to oncoming vehicles
- to crossing traffic
- to stationary obstacles
- when cornering

As a result, the Adaptive Brake Assist may not intervene in all critical conditions. There is a risk of an accident.

Always pay careful attention to the traffic situation and be ready to brake.

Adaptive Brake Assist aids you when braking during hazardous situations at speeds above 20 mph (30 km/h). With the help of Adaptive Brake Assist, the distance warning signal can detect obstacles that are in the path of your vehicle for an extended period of time.

When you approach an obstacle and adaptive Brake Assist detects that there is a risk of a collision, adaptive Brake Assist calculates the braking force necessary to avoid a collision. Should you apply the brakes forcefully, adaptive Brake Assist will automatically increase the braking force to the calculated level.

- ▶ Keep the brake pedal depressed until the emergency braking situation is over. ABS prevents the wheels from locking.

The brakes function as usual again if:

- you release the brake pedal
- there is no longer any danger of a collision
- no obstacle is detected in front of your vehicle

Adaptive Brake Assist is then deactivated.

Up to the maximum vehicle speed, adaptive Brake Assist can react to moving obstacles that have already been recognized as such at least once over the period of observation. Adaptive Brake Assist does not react to stationary obstacles.

In particular, the detection of obstacles can be impaired if:

- dirt on the sensors or anything else covering the sensors
- snow or heavy rain
- interference from other radar sources
- there are strong radar reflections, for example in parking garages
- a narrow vehicle traveling in front, e.g. a motorbike
- a vehicle traveling in front on a different line

If adaptive Brake Assist is not available due to a malfunction in the radar sensor system, the full brake boosting effect with the help of BAS remains available.

Following damage to the front end of the vehicle, have the configuration and operation of the radar sensor checked at a qualified specialist workshop. This also applies to collisions at slow speeds where there is no visible damage to the front of the vehicle.

Lane Tracking package

Blind Spot Assist

General notes

Blind Spot Assist uses a radar sensor system to monitor the areas on both sides of your vehicle. It supports you from speeds of approximately 20 mph (30 km/h). A warning display in the exterior mirrors draws your attention to vehicles detected in the monitored area. If you then switch on the corresponding turn signal to change lane, you will also receive an optical and audible collision warning. For this purpose, Blind

Spot Assist uses sensors in the rear bumper and behind the protective strips of the B-pillars.

Important safety notes

WARNING

Blind Spot Assist does not react to:

- vehicles overtaken too closely on the side, placing them in the blind spot area
- vehicles which approach with a large speed differential and overtake your vehicle

As a result, Blind Spot Assist may not give warnings in such situations. There is a risk of an accident.

Always observe the traffic conditions carefully, and maintain a safe lateral distance.

Blind Spot Assist is only an aid. It may fail to detect some vehicles and is no substitute for attentive driving.

USA only:

This device has been approved by the FCC as a "Vehicular Radar System". The radar sensor is intended for use in an automotive radar system only. Removal, tampering, or altering of the device will void any warranties, and is not permitted by the FCC. Do not tamper with, alter, or use in any non-approved way.

Any unauthorized modification to this device could void the user's authority to operate the equipment.

Monitoring range of the sensors

In particular, the detection of obstacles can be impaired in the case of:

- dirt on the sensors or anything else covering the sensors
- poor visibility, e.g. due to fog, heavy rain or snow
- narrow and short vehicles, e.g. motorcycles or bicycles
- very wide lanes
- narrow lanes
- vehicles not driving in the middle of their lane
- barriers or other road boundaries

Vehicles in the monitoring range are then not indicated.

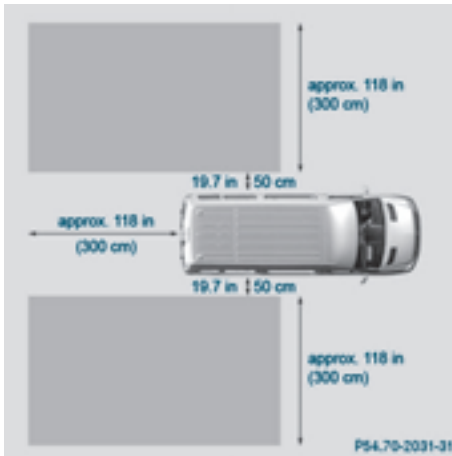

Blind Spot Assist monitors the area approximately 10 ft (3.0 m) behind your vehicle and approximately 1.6 ft (0.5 m) to 11.5 ft (3.5 m) each side of it. For this purpose, Blind Spot Assist uses radar sensors in the rear bumper and behind the protective strips of the B-pillars.

If the lanes are narrow, vehicles driving in the lane beyond the lane next to your vehicle may be indicated, especially if the vehicles are not driving in the middle of their lane. This may be the case if the vehicles are driving on the inner side of their lane.

Due to the nature of the system:

- a clear warning situation may not occur. The yellow indicator lamp on the relevant side of the vehicle will then light up.
- warnings may be issued in error when driving close to crash barriers or similar solid lane borders.
- warnings may be interrupted when driving alongside particularly long vehicles, for example trucks, for a prolonged time.

The four sensors of Blind Spot Assist are integrated into the rear bumper and behind the protective strips of the B-pillars. Make sure that the bumper and protective stripping are free of dirt, ice or slush in the vicinity of the sensors. The radar sensors must not be covered, for example by cycle racks or overhanging loads.

Have the function of the radar sensors checked at a qualified specialist workshop:

- after a severe impact
- after damage to the bumper
- after damage to the protective strips of the B-pillars

Blind Spot Assist may otherwise not work properly.

Indicator and warning display

Blind Spot Assist is not active at speeds below approximately 20 mph (30 km/h). Vehicles in the monitoring range are then not indicated.



① Yellow indicator lamp/red warning lamp

If yellow indicator lamp ① lights up:

- you are driving at less than 20 mph (30 km/h)
- Blind Spot Assist is deactivated
- Blind Spot Assist is malfunctioning
- there is no clear warning, depending on the situation

Blind Spot Assist is active from a speed of 20 mph (30 km/h). If a vehicle is detected in the blind spot monitoring range, red warning lamp ① on the corresponding side lights up. This warning occurs when a vehicle enters the blind spot monitoring range from behind or from the side. When you overtake a vehicle, the warning only occurs if the difference in speed is less than 14 mph (22 km/h).



Yellow indicator lamp ① goes out if reverse gear is engaged. Blind Spot Assist is then deactivated.

The brightness of the indicator/warning lamps is adjusted automatically according to the ambient light.

Collision warning

If a vehicle is detected in the monitoring range of Blind Spot Assist and you switch on the corresponding turn signal, a double warning tone sounds once. Red warning lamp ① flashes. If the turn signal remains on, detected vehicles are indicated by the flashing of red warning lamp ①. There are no further warning tones.

Activating/deactivating Blind Spot Assist

- ① Blind Spot Assist is activated when you switch on the ignition.
- ▶ Turn the key to position **2** in the ignition lock. Warning lamps ① in the exterior mirrors light up red for approximately 1.5 seconds and then turn yellow.
- ▶ **To deactivate:** press the  button in the center console (▷ page 35). The yellow indicator lamp in exterior mirror ① first flashes and then lights up continuously.
- ▶ **To activate:** press the  button in the center console again (▷ page 35). The yellow indicator lamp in exterior mirror ① flashes initially. If you exceed 20 mph (30 km/h) while driving, the yellow indicator lamp in exterior mirror ① goes out.

Towing a trailer

If you attach a trailer, make sure that you have correctly established the electrical connection. This can be accomplished by checking the trailer lighting. Blind Spot Assist is deactivated as a result. The indicator lamp in the exterior mirrors lights up yellow.

On vehicles with steering wheel buttons, the **Blind Spot Assist Deactivated** message also appears in the display.

Lane Keeping Assist

General notes

Lane Keeping Assist monitors the area in front of your vehicle by means of a camera at the top of the windshield. Lane Keeping Assist detects lane markings on the road and warns you before you leave your lane unintentionally.



① Lane Keeping Assist camera

Lane Keeping Assist supports you from speeds of approximately 40 mph (60 km/h).

If Lane Keeping Assist detects lane markings, the  indicator lamp in the instrument cluster lights up green. Lane Keeping Assist is operational.

Important safety notes

WARNING

Lane Keeping Assist may not always clearly recognize lane markings.

In this case, Lane Keeping Assist may:

- give an unnecessary warning
- not give a warning

There is a risk of an accident.

Always pay particular attention to the traffic situation and stay in lane, in particular if warned by Lane Keeping Assist.

WARNING

The Lane Keeping Assist warning does not return the vehicle to the original lane. There is a risk of an accident.

You should always steer, brake or accelerate yourself, in particular if warned by Lane Keeping Assist.

If you fail to adapt your driving style, Lane Keeping Assist can neither reduce the risk of accident nor override the laws of physics. Lane Keeping Assist cannot take into account road, weather or traffic conditions. Lane Keeping Assist is only an aid. You are responsible for the distance to the vehicle in front, for vehicle speed, braking in good time and for staying in your lane.

Lane Keeping Assist does not keep your vehicle in its lane.

The system may be impaired or may not function if:

- if the vehicle is incorrectly loaded (▷ page 212)
- there is poor visibility, e.g. due to insufficient illumination of the road, or due to snow, rain, fog or spray
- there is glare, e.g. from oncoming traffic, the sun or reflection from other vehicles (e.g. if the road surface is wet)
- the windshield is dirty, fogged up, damaged or covered, for instance by a sticker, in the vicinity of the camera
- no, or several, unclear lane markings are present for one lane, e.g. in a construction area
- the lane markings are worn away, dark or covered up, e.g. by dirt or snow
- the distance to the vehicle in front is too small and the lane markings thus cannot be detected
- the lane markings change quickly, e.g. lanes branch off, cross one another or merge
- the road is narrow and winding
- there are highly variable shade conditions on the road

A warning may be given if a front wheel passes over a lane marking. In addition, a warning tone sounds and the  indicator lamp in the instrument cluster flashes red.

Activating/deactivating Lane Keeping Assist

Lane Keeping Assist is automatically activated when you start the engine.

► **To deactivate:** press the  button in the center console (▷ page 35).

On vehicles without steering wheel buttons:

OFF flashes briefly in the display and the  indicator lamp in the instrument cluster flashes yellow and then lights up continuously.



On vehicles with steering wheel buttons:

The **Lane Keep. Assist Deactivated** message appears in the display and the  indicator lamp in the instrument cluster flashes yellow and then lights up continuously.



Lane Keeping Assist is deactivated.

► **To activate:** press the  button in the center console again (▷ page 35).

On vehicles without steering wheel buttons:

ON flashes briefly in the display and the  indicator lamp in the instrument cluster goes out. If a lane marking is detected, the  indicator lamp lights up green.

On vehicles with steering wheel buttons:

The **Lane Keep. Assist Activated** message appears in the display and the  indicator lamp in the instrument cluster goes out. If a lane marking is detected, the  indicator lamp lights up green.

Lane Keeping Assist is activated.

A Lane Keeping Assist warning is suppressed if:

- a driving safety system intervenes, such as ABS, BAS or ESP®.
- you have set the turn signal and a lane change is detected. In this case, the warnings are suppressed for a certain period of time.
- you accelerate hard, e.g. kickdown on vehicles with an automatic transmission.
- you brake hard.
- you steer actively, e.g. swerve to avoid an obstacle or change lane quickly.
- you cut the corner on a sharp bend.

In order that you are warned only when necessary and in good time if you cross the lane marking, the system recognizes certain conditions and warns you accordingly.

Lane Keeping Assist warns you earlier if:

- you approach the outer lane marking on a bend.
- the road has very wide lanes, e.g. a freeway.
- the system recognizes solid lane markings.

Warnings are given later if:

- the road has narrow lanes.
- you cut the corner on a bend.

All-wheel drive

Important safety notes

! Never tow the vehicle with one axle raised. This may damage the transfer case. Damage of this sort is not covered by the Mercedes-Benz Limited Warranty. All wheels must

remain either on the ground or be fully raised. Observe the instructions for towing the vehicle with all wheels in full contact with the ground.

! A function or performance test should only be carried out on a two-axle dynamometer. Before you operate the vehicle on such a dynamometer, please consult a qualified workshop. You could otherwise damage the drive train or the brake system.

If you fail to adapt your driving style or if you are inattentive, the all-wheel drive system can neither reduce the risk of an accident nor override the laws of physics. The all-wheel drive system cannot take road, weather and traffic conditions into account. The all-wheel drive system is only an aid. You are responsible for the distance to the vehicle in front, for vehicle speed and for braking in good time.

4ETS ensures permanent drive for all four wheels, and together with ESP® it improves the vehicle's traction.

If a driven wheel spins due to lack of traction:

- When pulling away, make use of the traction control integrated in ESP®. Depress the accelerator pedal as far as necessary.
- While driving, slowly take your foot off the accelerator pedal

In wintry driving conditions, always use winter tires (M+S tires) and if necessary, snow chains (▷ page 249). This is the only way to get the full benefit from the all-wheel drive system.

For information on "Driving off-road", see (▷ page 137).

Engaging all-wheel drive

Conditions for engaging/disengaging

All-wheel drive can only be engaged or disengaged if:

- the engine is running
- the vehicle is stationary



If it is not possible to engage all-wheel-drive:



- move the selector lever to position **N**
- release the brake pedal
- press the  button
- move the selector lever from **N** to **D** or **R**

Engaging/disengaging all-wheel drive





► **To engage/disengage:** press the  button.

The indicator lamp in the  button flashes. The  and  indicator lamps light up in the instrument cluster. ESP® and ASR are deactivated for the duration of the engaging/disengaging process.

If the engaging/disengaging process is successful, the  and  indicator lamps in the instrument cluster go out and ESP® and ASR are reactivated.

If the indicator lamp in the  button is lit, all-wheel drive is engaged. On vehicles with steering-wheel buttons, the display then shows the following message: **Four-wheel drive active**.

If the engaging/disengaging process fails, the indicator lamp in the  button flashes three times briefly. One of the gear change conditions was not fulfilled.

As long as the indicator lamp in the  button is flashing, you can cancel the engaging/disengaging process by pressing the  again.

i If the LOW RANGE transmission ratio (▷ page 148) is engaged, all-wheel drive cannot be disengaged.

LOW RANGE transmission ratio

General notes

The LOW RANGE transmission ratio assists you when driving on difficult terrain. If you engage LOW RANGE, the engine's performance characteristics and the automatic transmission's shifting characteristics are adjusted accordingly. The transmission ratio from the engine to the wheels is around 40% lower than in the on-road position. This increases the drive torque.

Conditions for engaging/disengaging

LOW RANGE can only be engaged or disengaged if:

- the engine is running
- the vehicle is stationary
- the brake pedal is depressed
- the selector lever of the automatic transmission is in position **P** or **N**
- all-wheel drive is engaged

Engaging and disengaging LOW RANGE



① Engages and disengages LOW RANGE

► **To engage or disengage:** press button ① or ②.

The **LOW RANGE** indicator lamp flashes in the instrument cluster for the duration of the engaging/disengaging process.

If the engaging/disengaging process is successful:

- and LOW RANGE is engaged, the **LOW RANGE** indicator lamp lights up.
- and LOW RANGE is disengaged, the **LOW RANGE** indicator lamp goes out.

As long as the **LOW RANGE** indicator lamp is flashing, you can cancel the engaging/disengaging process by pressing button ① or ② again.

If the engaging/disengaging process fails, the **LOW RANGE** indicator lamp briefly flashes three times. One of the gear change conditions was not fulfilled.

DSR (Downhill Speed Regulation)

Important safety notes

Observe the notes on braking in the section on "Driving and parking". If you fail to adapt your driving style or you are inattentive, DSR can neither reduce the risk of accident nor override the

laws of physics. DSR cannot take road, weather and traffic conditions into account. DSR is only an aid. You are responsible for the distance to the vehicle in front, for vehicle speed and for braking in good time.

General notes

DSR supports you with the LOW RANGE transmission ratio when you are driving downhill off-road and on construction sites. DSR maintains a preset speed for you on downhill gradients by applying the brakes as required. Maintaining the speed is dependent on the road surface conditions and the downhill gradient and cannot therefore be guaranteed in all situations.

You can set the speed to between 2.5 mph (4 km/h) and 11 mph (18 km/h) using the brake and accelerator pedals or the cruise control lever.

- If the vehicle is stationary, or its speed is less than 2.5 mph (4 km/h) the speed is set to 2.5 mph (4 km/h).
- If you drive faster than 11 mph (18 km/h) off-road, DSR switches to standby mode. DSR remains activated, but does not brake automatically.
- If you drive downhill slower than 11 mph (18 km/h), DSR sets the speed to the previously set speed.
- DSR switches off automatically if you drive faster than 28 mph (45 km/h).

Cruise control lever



- ① Activates DSR and stores the current or higher speed
- ② Activates DSR and stores the current speed
- ③ Activates DSR and stores the current or lower speed
- ④ Deactivates DSR

The cruise control lever is the uppermost lever on the left of the steering column. For as long as

the LOW RANGE transmission ratio is engaged, only use the cruise control lever to operate DSR. When the LOW RANGE transmission ratio is disengaged, use cruise control.

Activation conditions

In order to activate DSR, both activation conditions must be fulfilled:

- The LOW RANGE transmission ratio is engaged. The **LOW RANGE** indicator lamp in the instrument cluster lights up.
- The vehicle is stationary or you are not driving faster than 11 mph (18 km/h).

Activating DSR

You can activate DSR when the vehicle is stationary or moving.

- ▶ Brake or accelerate the vehicle to the required speed between 2.5 mph (4 km/h) and 11 mph (18 km/h).
- ▶ Briefly push the cruise control lever up ① or down ③.

or

- ▶ Briefly pull the cruise control lever towards you ②.
- ▶ Release the brake or accelerator pedal. The current speed is stored. When the vehicle is stationary, the speed is stored at 2.5 (4 km/h). DSR maintains the stored speed on the downhill gradient and brakes automatically.

When DSR is activated and the vehicle pulls away, accelerates or brakes, the speed set corresponds to the speed at which the accelerator or brake pedal is released. This is only the case if you are not driving faster than 11 mph (18 km/h).

DSR status indicator in the on-board computer

Vehicles with steering wheel buttons

LOW RANGE is engaged

- The **DSR** message is displayed in the status area of the on-board computer.
- DSR can be activated.

DSR is activated

- The **DSR** message and the set speed are displayed in the status area of the on-board computer.

DSR is activated but is not intervening

- You are driving at between 11 mph (18 km/h) and 28 mph (45 km/h).
- The **DSR** message is displayed in the status area of the on-board computer. Also, the speed 11 mph (18 km/h) flashes.

DSR is activated but is not intervening

- You are driving faster than 28 mph (45 km/h).
- The **DSR** message is displayed in the status area of the on-board computer. Also, the **---** message is displayed for 5 seconds.

DSR is activated but is not intervening

- The **DSR ---** message is displayed in the status area of the on-board computer.

There is a malfunction in the Electronic Braking System (EBS). Visit a qualified specialist workshop.

Setting the speed whilst driving downhill

You can set the speed to between 2.5 mph (4 km/h) and 11 mph (18 km/h) using the brake and accelerator pedals or the cruise control lever.

- ▶ Brake or accelerate the vehicle to the required speed on the downhill gradient.
- ▶ Release the brake or accelerator pedal. The current speed is stored.

or

- ▶ Briefly push the cruise control lever upwards ① to increase the speed or downwards ③ to reduce the speed. The last speed stored is increased or reduced incrementally.
- ▶ Release the cruise control lever. The current speed is stored.

or

- ▶ Press and hold the cruise control lever up ① or down ③ until the desired speed has been reached.
- ▶ Release the cruise control lever. The current speed is stored.

- ① It may take a moment before the vehicle brakes to the set speed. Take this delay into account when setting the speed with the cruise control lever.

Deactivating DSR

► Briefly press the cruise control lever forwards ④.

or

► Accelerate and drive faster than 28 mph (45 km/h).

DSR deactivates automatically if:

- you are driving faster than 28 mph (45 km/h).
- you disengage the LOW RANGE transmission ratio.
- there is a malfunction in the ESP® or ABS system.

PARKTRONIC

General notes

PARKTRONIC is an electronic parking aid. The system is equipped with ultrasonic sensors in the front and rear bumpers to monitor the area around your vehicle. PARKTRONIC indicates visually and audibly the distance between your vehicle and an object.

Your vehicle features two separate sound emitters with different frequencies for the warning tones. The warning ranges in front of and behind the vehicle are indicated by different warning tones.

PARKTRONIC is activated automatically when you:

- turn the key to position **2** in the ignition lock
- release the parking brake and
- move the selector lever to **D, N or R**.

PARKTRONIC is deactivated at speeds above 11 mph (18 km/h). PARKTRONIC is reactivated at speeds below 10 mph (16 km/h).

Important safety notes

PARKTRONIC is only an aid. It cannot replace your own awareness of the immediate surroundings. You are responsible for safe maneuvering, parking and pulling away. When maneuvering, parking and pulling away, make sure that there are no persons, animals or objects in the maneuvering area.

! Pay particular attention to obstacles above or below the sensors when parking, such as flower pots or trailer towbars. PARKTRONIC does not recognize such objects when they

are in the immediate vicinity of the vehicle. You could damage the vehicle or objects.

PARKTRONIC can suffer interference from:

- ultrasonic sources such as a truck's compressed-air brakes, an automatic car wash or a pneumatic drill
- attachments to the vehicle, e.g. rear mounted racks
- number plates (vehicle license plates) that are not affixed flat against the bumper
- dirty or icy sensors

Remove a detachable trailer coupling if it is no longer required. PARKTRONIC measures the minimum detection range to an obstacle from the bumper, not the ball coupling.

Range of the sensors

PARKTRONIC does not account for obstacles that are:

- beneath its detection range, e.g. persons, animals or objects
- above its detection range, e.g. overhanging loads, overhangs or truck loading ramps

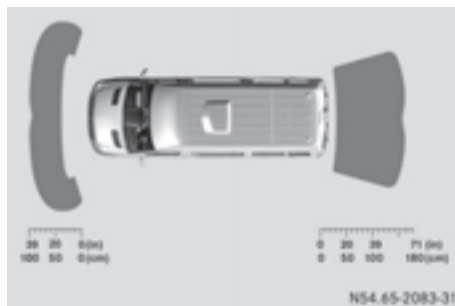

The sensors must be free of dirt, ice or slush. Otherwise, they cannot function correctly.

Clean the sensors regularly, taking care not to scratch or damage them (▷ page 236).

Front sensors

Center	Approx. 39 in (100 cm)
Corners	Approx. 26 in (65 cm)

Rear sensors

Center	Approx. 71 in (180 cm)
Corners	Approx. 39 in (100 cm)

Minimum distance

Center	Approx. 12 in (30 cm)
Front corner sensors	Approx. 10 in (25 cm)
Rear corner sensors	Approx. 12 in (30 cm)

If an obstacle is within this range, all segments of the warning displays light up and you hear a warning tone. If the distance between the vehicle and the obstacle falls below the minimum range, it is possible that the distance may no longer be displayed.

Warning displays



Warning display, front area

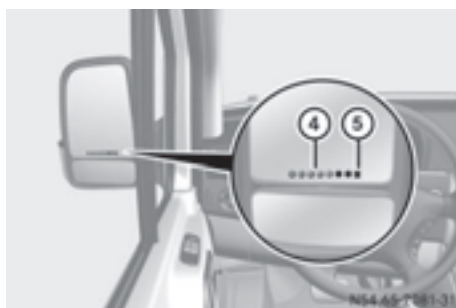

Warning display for the left-hand rear area in the left-hand exterior mirror

- ① Warning segments for the left front area
- ② Warning segments for the right front area
- ③ Operational readiness symbol for the front area
- ④ Warning display segments
- ⑤ Operational readiness symbol for the rear area

The warning displays show the distance between the sensor and the obstacle.

The warning display is divided into five yellow and two red segments for each side of the vehicle. PARKTRONIC is operational if yellow indicator segments ③ and ⑤ are lit.

There is a malfunction if only the red segments of the warning display light up .

The position of the gear lever determines whether the front and/or rear area is monitored.

Selector lever position	Monitoring
D	Front area
R or N	Front and rear area
P	No areas activated

One or more segments light up as the vehicle approaches an obstacle, depending on the vehicle's distance from the obstacle.

From the:

- sixth segment, an intermittent warning tone sounds for approximately 2 seconds.
- seventh segment, a continuous warning tone sounds. This indicates that you have now reached the minimum distance.

Roll-back warning

PARKTRONIC automatically monitors the area behind the vehicle if the vehicle begins to roll backwards without reverse gear engaged, e.g. after stopping on an uphill gradient.

If PARKTRONIC recognizes an obstacle at a distance of at most 31 in (80 cm), all the segments in the warning displays light up. A continuous warning tone also sounds as the vehicle approaches the obstacle and for a further 2 seconds after the vehicle has come to a halt.

Activating/deactivating PARKTRONIC



- Press the  button.
If PARKTRONIC is deactivated, the indicator lamp in the switch lights up.

Towing a trailer

PARKTRONIC detects a coupled trailer if your vehicle is equipped with the corresponding electrical installations for trailer towing.

PARKTRONIC is deactivated for the rear area when you establish an electrical connection between your vehicle and a trailer. If you use an adapter for the socket, remove it from the socket after detaching the trailer. Otherwise, PARKTRONIC remains deactivated for the rear area.

Remove a detachable trailer coupling if it is no longer required. PARKTRONIC measures the minimum detection range to an obstacle from the bumper, not the ball coupling.

Problems with PARKTRONIC

Problem	Possible causes/consequences and ► Solutions
<p>Only the red segments in the PARKTRONIC warning displays are lit.</p> <p>A warning tone also sounds for approximately 2 seconds.</p> <p>PARKTRONIC is deactivated after approximately 20 seconds.</p> <p>The indicator lamp of the  button lights up and the red segments in the PARKTRONIC warning display go out.</p>	<p>PARKTRONIC has malfunctioned and has switched itself off.</p> <p>► If problems persist, have PARKTRONIC checked at a qualified specialist workshop.</p>
<p>The PARKTRONIC warning displays implausible distances.</p> <p>For example, all the segments may be lit even though there is no obstacle present.</p>	<p>The PARKTRONIC sensors are dirty or iced up.</p> <p>► Clean the PARKTRONIC sensors (► page 236).</p> <p>► Turn the key to position 2 again in the ignition lock.</p> <p>The license plate or other parts attached near the sensors may not be secured correctly.</p> <p>► Check the license plate and attachment parts near the sensors for correct seating.</p> <p>An external radio or ultrasonic source may be causing interference.</p> <p>► Check PARKTRONIC functions in a different location.</p>

Rear view camera

Important safety notes

The rear view camera is only an aid. It cannot replace your own awareness of the immediate surroundings. You are responsible for safe maneuvering, parking and pulling away. When maneuvering, parking and pulling away, make sure that there are no persons, animals or objects in the maneuvering area.

The rear view camera is a visual parking aid. Information on operation can be found in the separate Audio 15 supplement.

The camera is in the middle of the roof above the high-mounted brake lamp (► page 236).

You can find information on cleaning the camera in the "Maintenance and care" section (► page 236).

Working mode

ADR (working speed governor)

General notes

When activated, ADR automatically increases the engine speed to a preset speed or a speed you have set.

i After a cold start, the idling speed of the engine is increased automatically. If the preset working speed is lower than the increased idling speed, the working speed is only reached once the engine has completed the warm-up phase.

It is only possible to activate ADR with the vehicle stationary and the parking brake applied.

The selector lever of the automatic transmission must be in position **P**.

Switching ADR on and off



► **To activate:** press upper section ① of the  switch while the engine is running. The indicator lamp in the switch comes on. The **ADR** indicator lamp in the instrument cluster lights up or the display shows the following message: **Operating speed governor active**.

► **To deactivate:** press lower section ② of the  switch while the engine is running. The indicator lamp in the switch goes out.

ADR is automatically deactivated if:

- you release the parking brake.
- the brake pedal is depressed.
- the vehicle moves.
- the control unit detects a malfunction.

Setting the working speed



► Activate ADR.

► **To increase:** press the  button.

► **To decrease:** press the  button.

Towing a trailer

Notes on trailer towing

Important safety notes

WARNING

Installing an unsuitable ball coupling may result in overloading of the trailer tow hitch and the rear axle. This applies especially if the ball coupling in question is longer or angled differently. This could seriously impair the driving characteristics and the trailer can come loose. There is a risk of an accident.

You should only ever install a ball coupling that has the permissible dimensions and that is designed to meet your trailer-towing requirements. Do not modify the ball coupling or the trailer tow hitch.

WARNING

If you use a ball coupling that is not approved for your vehicle, it may cause excessive strain on the trailer tow hitch. This can cause damage to the vehicle and the trailer may come loose during the journey. The handling may be impaired and the rear axle may be overloaded. This may lead to an accident involving serious or even fatal injury.

Therefore note the following:

- Only install a ball coupling that is approved for your vehicle.
- Before the journey, make sure that the ball coupling is correctly installed and secured. To do this, observe the operating instructions of the ball coupling manufacturer.
- Do not make any modifications to the ball coupling or the trailer tow hitch.

You must observe the operating instructions of the trailer tow hitch or ball coupling manufacturer.

WARNING

If the ball coupling is not correctly installed and secured, it could come loose while driving and endanger other road users. There is a risk of an accident and injury.

Install and secure the ball coupling as described in the ball coupling manufacturer's installation instructions. Make sure that the ball coupling is correctly installed and secured before every journey.

WARNING

When the vehicle/trailer combination begins to lurch, you could lose control of it. The vehicle/trailer combination could even rollover. There is a risk of an accident.

On no account should you attempt to straighten up the vehicle/trailer combination by increasing the speed. Reduce vehicle speed and do not countersteer. Apply the brake as necessary.

Always observe the operating instructions provided by the manufacturers of the trailer coupling and the ball coupling.

Couple and decouple the trailer carefully. When backing up the towing vehicle, make sure nobody is standing between the vehicle and the trailer.

A trailer which is incorrectly coupled to the towing vehicle could break away. A correctly coupled trailer must be positioned horizontally behind the towing vehicle.

Ensure that the following weights are not exceeded:

- the permissible noseweight
- the permissible trailer load
- the permissible rear axle load of the towing vehicle
- the permissible gross weight of both the towing vehicle and the trailer
- the permissible gross combination weight

The applicable permissible values that may not be exceeded can be found:

- in your vehicle documents
- on the type plates for the trailer tow hitch
- on the type plates for the trailer
- on the vehicle identification plate (▷ page 276).

Where the values differ, the lowest is valid.

You will find values approved by the manufacturer on the identification plates and those for the towing vehicle in the "Permissible trailer

loads and trailer drawbar noseweights" section (▷ page 159).

Your vehicle behaves differently with a trailer than without one.

The vehicle/trailer combination:

- is heavier
- is restricted in its acceleration and gradient-climbing capability
- has an increased braking distance
- is more susceptible to strong crosswinds
- requires more sensitive steering
- has a larger turning circle

This may impair the handling characteristics.

When towing a trailer, always adjust your speed to suit the road and weather conditions. Drive carefully. Maintain a safe distance.

If you require any further explanation of the information contained in the Operator's Manual, please contact an authorized Sprinter dealer.

General notes

- Observe the legally prescribed maximum speed for vehicle/trailer combinations in the relevant country, state or Canadian province. Before setting off, check the vehicle documents of the your trailer to find out the permissible maximum speed. This reduces the risk of accidents.
- Install only an approved trailer coupling on your vehicle. Only use a ball coupling that is approved for your vehicle and Sprinter trailer tow hitch. More information on the availability, mounting and installation of the trailer electrics is available at any qualified specialist workshop.
- The trailer coupling is one of the most important vehicle parts with regard to road safety. The notes on operation, care and maintenance issued by the manufacturer should be observed.
- The bumpers of your vehicle are not suitable for installing detachable trailer couplings.
- Do not attach rented trailer tow hitches or other detachable trailer tow hitches to the bumper.
- Minimize the risk of damage to the ball coupling. If you do not require the ball coupling, remove it from the ball coupling recess.

Weight information can be found in the “Permissible trailer and drawbar noseweights” section (▶ page 159).

- ❗ The height of the ball neck changes according to the load on the vehicle. If this is case, use a trailer with a height-adjustable trailer drawbar.

Driving tips

The maximum permissible speed for vehicle/trailer combination depends on the type of trailer. Before setting off, check the vehicle documents of the your trailer to find out the permissible maximum speed. Observe the legally prescribed maximum speed for vehicle/trailer combinations in the relevant country, state or Canadian province.

When towing a trailer, your vehicle's handling characteristics will be different in comparison to when driving without a trailer and it will consume more fuel.

On long, steep downhill slopes you must select shift range **3**, **2** or **1** in good time.

- ❗ This also applies if cruise control is activated.

This enables you to utilize the engine's braking effect and you do not need to brake so heavily to keep the correct speed, which protects the brake system and prevents the brakes from overheating and wearing too quickly. If you need to brake additionally, to not depress the brake pedal constantly, but periodically.

Driving tips

If the trailer begins to swing from side to side:

- ▶ Do not accelerate.
- ▶ Do not counter-steer.
- ▶ Brake if necessary.
- ❗ You can reduce the risk of the trailer swinging and rocking by retrofitting anti-roll bars or trailer stability programs. More information is available from your authorized Sprinter Dealer.

- Maintain a greater distance than you would when driving without towing a trailer.
- Avoid sudden braking. Apply the brakes gently at first to allow the trailer brake to overrun. Then, increase the brake force quickly.
- The figures for the gradient climbing capabilities from a standstill refer to sea level. When driving in mountainous areas, note that the power output of the engine, and with it its gradient climbing capability, decrease with increasing altitude.

Coupling up a trailer

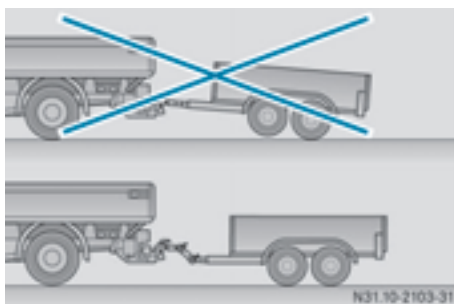

Trailer coupled ready for use

- ▶ Make sure the selector lever of the automatic transmission is in position **P**.
- ▶ Apply the vehicle's parking brake.
- ▶ Close all doors.
- ▶ Position the trailer horizontally behind your vehicle.
- ❗ The height of the ball neck changes according to the load on the vehicle. In this case, use a trailer with a height-adjustable trailer drawbar.
- ▶ Couple the trailer.
- ▶ Establish all electrical and other connections to the trailer. When doing so, hook the break-away cable of the trailer into eyelet ① on the ball coupling.
- ▶ Remove the objects that are preventing the trailer from rolling, e.g. wheel chocks.
- ▶ Release the trailer parking brake.
- ❗ The subharness of the vehicle has a cable connection to the brake lamp indicator lamp.

Observe the maximum permissible trailer dimensions (width and length).

Most federal states and all Canadian provinces require by law:

- safety chains between the towing vehicle and the trailer. The chains should be cross-wound under the trailer drawbar. They must be fastened to the vehicle's trailer coupling, not to the bumper or the axle.

Leave enough slack in the chains. This allows you to drive round tight corners.

- a separate brake system for certain types of trailer.
- a safety shut-off for braked trailers. Find out the specific requirements according to the applicable laws.

If the trailer becomes detached from the towing vehicle, the safety feature applies the trailer brakes.

Towing a trailer

There are numerous legal requirements concerning the towing of a trailer, e.g. speed restrictions. Make sure your vehicle/trailer combination complies with local laws. This not only means where you live, but also anywhere you are driving to. Information is available from the police and local authorities.

Observe the following when towing a trailer:

- Practice driving around bends, stopping and backing up at a place where there is no traffic. This enables you to gain experience and get used to the new handling characteristics.
- Before driving, check:
 - that the trailer tow hitch and ball coupling are secure
 - that the safety switch for a braked trailer is functioning properly
 - that the safety chains are secure and not damaged
 - that the electrical connections are secure
 - that the lights are working
 - that the wheels are in good order and the tire pressure is correct
- Adjust the exterior mirrors to provide an unobstructed view of the rear section of the trailer.
- If the trailer has electronically controlled brakes, pull the vehicle/trailer combination away carefully. Brake manually using the brake controller and check that the brakes are working.

- Secure the load on the trailer according to the applicable specifications and current standards on securing loads (▷ page 214).
- When driving with a trailer, check at regular intervals that the load is secured and that the brakes and lights are working.
- Bear in mind that the handling will be less stable when towing a trailer than when driving without one. Avoid sudden steering movements.
- The vehicle/trailer combination is heavier, accelerates more slowly and has a decreased gradient climbing capability and a longer braking distance.
 - It is more susceptible to crosswinds and requires cautious steering.
- If possible, do not brake suddenly, but rather moderately at first so that the trailer can activate its brakes. Then increase the force on the brake pedal.
- If the automatic transmission repeatedly shifts between gears when driving on inclines, restrict the shift range. Select shift range **4, 3, 2** or **1**.

Driving in a low gear and at a low speed reduces the risk of damaging the engine.

- When driving on a downhill gradient, shift to a low gear and take advantage of the engine's braking effect.
 - Avoid continuous brake application as this may overheat the vehicle brakes and, if installed, the trailer brakes.
- If the coolant temperature increases dramatically while the air-conditioning system is switched on, switch off the air-conditioning system.
 - Coolant heat can also be dissipated by switching the airflow and the temperature of the heater/air conditioning to the maximum level. Open the windows if necessary.
- When overtaking, pay particular attention to the extended length of your vehicle/trailer combination.
 - Due to the length of your vehicle/trailer combination you need an additional distance before you can return to your original lane.

Uncoupling a trailer

WARNING

If you uncouple a trailer with the overrun brake engaged, you could trap your hand between the vehicle and the trailer drawbar. There is a risk of injury.

Do not uncouple a trailer if the overrun brake is engaged.

- !** Do not disconnect a trailer with an engaged overrun brake. Otherwise, your vehicle could be damaged by the rebounding of the overrun brake.
- ▶ Make sure the selector lever of the automatic transmission is in position **P**.
- ▶ Apply the parking brake of the vehicle.
- ▶ Close all doors.
- ▶ Apply the parking brake of the trailer.
- ▶ In addition, secure the trailer against rolling away with a wheel chock or similar object.
- ▶ Remove the trailer cable and safety chains and decouple the trailer.

Permissible trailer loads and trailer drawbar noseweights

Weight information

! On vehicles with a permissible gross vehicle weight of 11030 lbs (5003 kg), the permissible gross combination weight is less than the total of the permissible gross vehicle weight and the permissible trailer load. Exceeding the permissible gross combination weight can lead to damage to the drivetrain, to the transmission or to the trailer tow hitch.

If the vehicle or the trailer is fully laden, the relevant value for the permissible gross vehicle weight or the permissible trailer load is therefore lower. In this case, the trailer or the vehicle may only be partially loaded.

The gross trailer weight (GTW) is calculated by adding the weight of the trailer to the weight of the load and equipment.

The maximum gross vehicle weight is vehicle-specific and equipment-dependent: 5,000 lbs (2,268 kg) or 7,500 lbs (3,402 kg).

The maximum permissible trailer drawbar noseweight on the ball coupling is 500 lbs (227 kg) or

750 lbs (340 kg). The actual noseweight may not exceed the value given on the identification plates of the trailer tow hitch or the trailer. If the values vary, the lowest value always applies.

The gross combination weight rating (GCWR) is calculated by adding the gross weight of the trailer to the gross vehicle weight including a driver's weight of approximately 150 lbs (68 kg). The permissible Gross Combination Weight Rating is vehicle-specific and depends on the equipment level.

When driving with a trailer, you should not exceed the permitted Gross Combination Weight Rating (GCWR).

The permissible values, which must not be exceeded, can be found in your vehicle documents and on the trailer tow hitch type plates for the trailer and the vehicle (▷ page 276). The basic values approved by the manufacturer can also be found in the "Technical data" section (▷ page 286). If the values vary, the lowest value always applies.

Loading a trailer

! Utilize the maximum permissible noseweight as fully as possible. Do not allow the weight to fall below the minimum permissible noseweight, otherwise the trailer may come loose.

- You must distribute the load on the vehicle and trailer so that the permitted maximum values for the gross vehicle weight (GVWR), gross trailer weight (GTW) and gross combined weight (GCWR) as well as permitted gross axle loads (GAWR) and noseweight (TWR) of your vehicle are not exceeded.
- Add the drawbar noseweight on the ball coupling (TWR) to the rear axle load. This will prevent you from exceeding the permissible gross axle weight (GAWR).
- Add the drawbar noseweight on the ball coupling (TWR) to the vehicle payload. This will prevent you from exceeding the permissible gross vehicle weight (GVWR).

Checking the vehicle and trailer weight

- Make sure the weights of the towing vehicle and the trailer comply with the maximum permissible values. Have the vehicle/trailer combination weighed on a calibrated weighbridge. The vehicle/trailer combination consists of the towing vehicle including the driver,

passengers and load, as well as the loaded trailer.

- Check the maximum permissible gross axle weight rating of the front and rear axles (GAWR), the gross trailer weight (GTW), the gross combination weight rating (GCWR) and the noseweight of the trailer drawbar (TWR).

Trailer power supply

! Incorrect wiring of the connector plug could, under certain circumstances, cause malfunctions in the vehicle's other electronic systems. We therefore recommend having the connector plug wired at a qualified specialist workshop.

! You can connect accessories with a maximum power consumption of 240 W to the permanent power supply.

You must not charge a trailer battery using the power supply.

Your vehicle may be equipped with various electrical installations for trailer towing. Depending on your trailer, you may need an adapter to connect the electrical system of the trailer with that of the vehicle.

The trailer socket of your vehicle is equipped at the factory with a permanent power supply.

The permanent power supply is on the trailer socket pin assignment 4.

Note that the permanent power supply of the trailer is not switched off when the on-board voltage is low. This can completely discharge the starter battery of your vehicle.

Further information on the electrical equipment currently installed on your vehicle and on installing trailer electrics can be obtained at any qualified specialist workshop.

Useful information

This Operator's Manual describes all models as well as standard and optional equipment of your vehicle that were available at the time of going to print. Country-specific variations are possible. Note that your vehicle may not be equipped with all of the described functions. This also applies to systems and functions relevant to safety.

Read the information on qualified specialist workshops (▷ page 26).

Important safety notes

⚠ WARNING

If you are driving and reach through the steering wheel to operate the adjustment knob, you could lose control of the vehicle. There is a risk of an accident and injury.

Only operate the adjustment knobs when the vehicle is stationary. Do not reach through the steering wheel when driving.

⚠ WARNING

If you operate information systems and communication equipment integrated in the vehicle while driving, you will be distracted from traffic conditions. You could also lose control of the vehicle. There is a risk of an accident.

Only operate the equipment when the traffic situation permits. If you are not sure that this is possible, park the vehicle paying attention to traffic conditions and operate the equipment when the vehicle is stationary.

⚠ WARNING

If the instrument cluster has failed or malfunctioned, you may not recognize function restrictions in systems relevant to safety. The operating safety of your vehicle may be impaired. There is a risk of an accident.

Drive on carefully. Have the vehicle checked at a qualified specialist workshop immediately.

You must observe the legal requirements for the country in which you are currently driving when operating the on-board computer.

The on-board computer display only shows messages and warnings from certain systems. You should therefore make sure your vehicle is operating safely at all times. If the operating safety of your vehicle is impaired, stop the vehicle as soon as possible, paying attention to road and traffic conditions. Then consult a qualified specialist workshop.

Instrument cluster

Overview



- ① Instrument cluster on vehicles without steering wheel buttons
- ② Instrument cluster in vehicles with steering-wheel buttons
- ③ Adjustment buttons (+) and (-)
- ④ Reset button (⓪)
- ⑤ Service button (Ⓜ) (engine oil level check)
- ⑥ Menu button (M)

You will find a full overview of the instrument cluster in the "At a glance" section (▷ page 32). The display in the instrument cluster is activated when you:

- open the driver's door
- turn the key to position 2 in the ignition lock
- press the (⓪) reset button
- switch on the lights

The display switches off automatically after approximately 30 seconds if:

- the key is in position **0** in the ignition lock.
- the vehicle lighting is not switched on.

Instrument lighting

When the lights are switched on, you can adjust the brightness of the instrument cluster lighting using the **+** and **-** buttons.

- ▶ **To brighten:** press the **+** button.
- ▶ **To dim:** press the **-** button.

i Vehicles with automatic headlamp mode: the instrument lighting also adapts to automatic headlamp mode.

Tachometer

! Do not drive in the overrevving range, as this could damage the engine.

Environmental note

Avoid driving at high engine speeds. This unnecessarily increases the fuel consumption of your vehicle and harms the environment as a result of increased emissions.

The red band in the tachometer indicates the engine's overrevving range.

To protect the engine, the fuel supply is interrupted when the red band is reached.

Outside temperature

You should pay special attention to road conditions when temperatures are around the freezing point.

On vehicles without steering wheel buttons (▷ page 163) and on vehicles with steering wheel buttons (▷ page 167), the outside temperature display is in the display.

Changes in the outside temperature are displayed after a short delay.

Speedometer

The speed can also be shown in the display. You can find information on the digital speedometer

for vehicles without steering wheel buttons under (▷ page 163) and for vehicles with steering wheel buttons under (▷ page 167).

i In some countries, a warning sounds when the vehicle reaches the maximum speed limit, e.g. at 75 mph (120 km/h).

Trip odometer

- ▶ **To reset:** make sure that the display is showing the trip odometer if you have a vehicle with steering wheel buttons (▷ page 167).
- ▶ Press and hold the **0** reset button until the trip odometer is reset to **0.0**.

Fuel gage

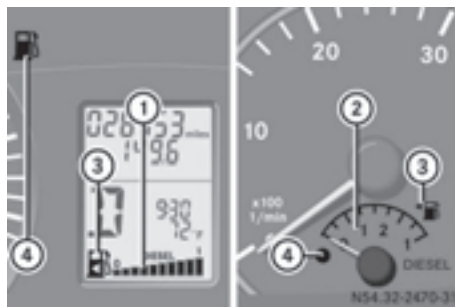



- ① Fuel gage on vehicles without steering wheel buttons
- ② Fuel gage on vehicles with steering wheel buttons
- ③ Fuel filler flap location indicator **◀**: the fuel filler flap is on the left-hand side. Fuel filler flap location indicator **▶**: the fuel filler flap is on the right-hand side
- ④ Reserve fuel warning lamp (▷ page 200)

DEF gage

Vehicles without steering wheel buttons



If the DEF supply is less than 1.5 US gal (5.5 l), the **dEF Chk** message appears in the display.

In addition, the yellow  DEF indicator lamp lights up in the instrument cluster and a warning tone sounds.

If the supply of DEF falls below the reserve range of 0.8 US gal (3.0 l), the **StArTS REXx** message appears in the display. In addition, the yellow  DEF indicator lamp lights up in the instrument cluster and three warning tones sound.

In the display, **xx** corresponds to the number of possible remaining engine starts (**16 to 0**).

When the display shows that the number of remaining starts is **0**, the **StArTS IdLE** message appears in the display and three warning tones sound.

In addition, the yellow  DEF indicator lamp and the  Check Engine indicator lamp light up in the instrument cluster and three warning tones sound.

The engine management only allows speeds of up to 5 mph (8 km/h).

Add at least 1.5 US gal (5.5 l) of DEF (▷ page 129).

The display message only disappears when the vehicle is stationary, at the latest after 20 seconds as soon as you switch on the ignition or start the engine after refueling.

Vehicles with steering wheel buttons

If the supply of DEF is less than 1.5 US gal (5.5 l), the **Check Diesel Exhaust Fluid see Operator's Manual** message appears in the display.

If the supply of DEF falls below the reserve range of 0.8 US gal (3.0 l), the **XX starts remaining** message is displayed.

Three short warning tones also sound.

In the display, **xx** corresponds to the number of possible remaining engine starts (**16 to 0**).

When the display shows that the number of remaining starts is **0**, the **StArTS IdLE** message appears in the display.

The yellow  Check Engine indicator lamp also lights up and three short warning tones sound.

The engine management only allows speeds of up to 5 mph (8 km/h).

Add at least 1.5 US gal (5.5 l) of DEF (▷ page 129).

The display message only disappears when the vehicle is stationary, at the latest after 20 seconds as soon as you switch on the ignition or start the engine after refueling.

On-board computer (vehicles without steering wheel buttons)

Operating the on-board computer

General notes

The on-board computer is activated as soon as you turn the key to position **1** in the ignition lock.

The on-board computer shows vehicle information and settings in the display.

You can control the display and the settings in the on-board computer using the adjustment buttons on the instrument cluster.

Standard display

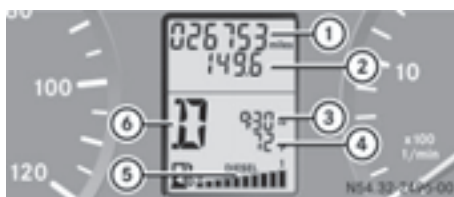

- ① Odometer
- ② Trip odometer
- ③ Clock
- ④ Outside temperature or digital speedometer
- ⑤ Fuel gage (▷ page 162)
- ⑥ Selector lever position or current shift range with automatic transmission (▷ page 124)

► **To call up the standard display:** turn the key to position **2** in the ignition lock.

► Press the  menu button for longer than 1 second.
The information shown in the display changes from the outside temperature to the digital speedometer.

Menus in the on-board computer

Overview

If you wish to exit a menu and go to the standard display:

► Press the  menu button for longer than 1 second.

or

► Do not press any button for 10 seconds.
The display accepts the changed settings.

Using the **+**, **-**, **M** or **⊖** adjustment buttons, you can select the following functions:

- Calling up the service due date (▷ page 226)
- Checking the oil level (▷ page 220)
- Checking the DEF supply (▷ page 162)
- Preselecting/setting the auxiliary heating switch-on time (▷ page 108)
- Tire pressure monitor (▷ page 253)
- Setting the time (▷ page 164)
- Activating/deactivating Highbeam Assist (▷ page 171)
- Setting the daytime running lamps (▷ page 79)

Setting the time

- ▶ Turn the key to position **2** in the ignition lock.
- ▶ Press the **M** menu button repeatedly until the hours figure flashes.
- ▶ Press the **+** or **-** button to set the hour.
- ▶ Press the **⊖** reset button. The minute display flashes.
- ▶ Press the **+** or **-** button to set the minute.

i If you keep the **+** or **-** button pressed, the value will change continuously.

Activating/deactivating Highbeam Assist

- ▶ Turn the key to position **2** in the ignition lock.
- ▶ Press the **M** menu button repeatedly until the  indicator lamp flashes and the **on** or **OFF** message appears in the display.
- ▶ Use the **+** or **-** button to switch Highbeam Assist on/off.



Switching the daytime running lamps on/off

If you switch the daytime running lamps **on**, the daytime running lamps will automatically light up when the engine is running.



For safety reasons, it is only possible to change this setting when the vehicle is stationary. The factory setting is **on** in countries in which daytime running lamp mode or daytime running lamps are mandatory.

- ▶ Turn the key to position **2** in the ignition lock.
- ▶ Press the **M** menu button repeatedly until the  indicator lamp flashes and the **on** or **OFF** message appears in the display.
- ▶ Press the **+** or **-** button to activate or deactivate the daytime running lamps.

i USA only:

If you turn the light switch to  or , the corresponding light switches on. If you turn the light switch to **AUTO**, the daytime running lamps remain switched on.

Canada only:

If you turn the light switch to , the low-beam headlamps switch on. If you turn the light switch to  or **AUTO**, the daytime running lamps remain switched on.

On-board computer (vehicles with steering wheel buttons)

Operating the on-board computer









Overview



- ▶ **To activate the on-board computer:** turn the key to position **1** in the ignition lock.





The on-board computer shows vehicle information and settings in the display.

You can control the display and the settings in the on-board computer with the buttons on the steering wheel.

①	Display
	On-board computer operation
②	 and  <ul style="list-style-type: none"> • Selects submenus • Changes values • Adjusts the volume Using the telephone  Accepts a call  Ends a call
③	Scrolls from one menu to another  Forwards  Back Scrolls within a menu  Forwards  Back

Controls

You can think of the order of the menus and of the functions within a menu as a circle:

- ▶ Press the  or  button repeatedly. The menus are displayed one after the other.
- ▶ Press the  or  button repeatedly. The functions in the menu or submenu are displayed successively.

Several functions are combined thematically in the menus.

The display changes when you press one of the buttons on the steering wheel. You can use a function to call up information or to change the settings for the vehicle.

For example, the **AUDIO** menu has functions for controlling the radio or CD player.

Unlike in other menus, you will find submenus in the **Settings** menu. For information on how to use these submenus, see the "Settings menu" section (▶ page 168).

The number of menus depends on your vehicle's equipment.

- i** Operation of the audio equipment using the steering wheel buttons and making settings using the **AUDIO** menu only function with Sprinter audio equipment. If you are using audio equipment from another manufacturer, the described functions may be restricted or not available at all.

Menu overview

Diagrams

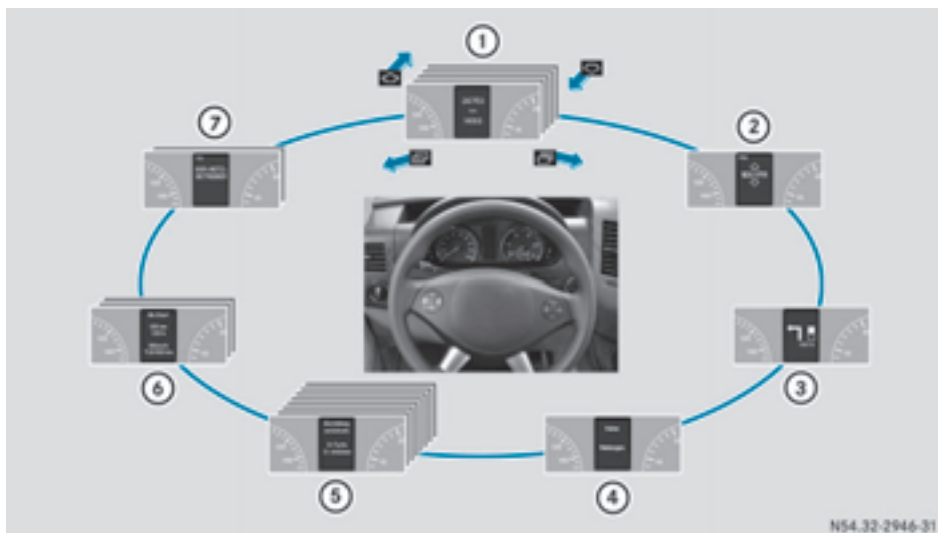

This is what the displays look like when you scroll through the menus.

Generic terms

The illustration shows the menus on a vehicle with Audio 15.

On Sound 5/Audio 20, the on-board computer always shows the **AUDIO** and **TEL** (telephone) menus in English. This is the case even if a different language is selected for the display.

	Operation
①	Operation menu (▷ page 166) <ul style="list-style-type: none"> • Standard display • Calling up the service due date (▷ page 226) • Tire pressure monitor (▷ page 253) • Checking the engine oil level (▷ page 220)
②	Audio menu (▷ page 167)
③	Message memory menu (▷ page 176)
④	Settings menu (▷ page 168)
⑤	Trip computer menu (▷ page 174)
⑥	Telephone menu (▷ page 175)

i The generic terms in the tabular overview should make orientation easier for you. However, they are not always shown on the display.

Operation menu

Overview

You can select the following functions in the **Operation** menu by pressing the or button on the steering wheel:

- Displaying the trip odometer and odometer (standard display) (▷ page 167)
- Displaying the coolant temperature (▷ page 167)
- Calling up the service due date (▷ page 226)
- Tire pressure monitor (▷ page 253)
- Checking the oil level (▷ page 220)

Standard display

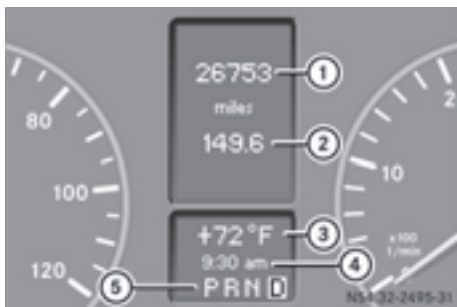

- ① Odometer
- ② Trip odometer
- ③ Outside temperature or digital speedometer
- ④ Clock
- ⑤ Selector lever position or current shift range (> page 124)

In the basic setting, the odometer and the trip odometer are shown in the upper part of the display. This is referred to as the standard display.

Using the steering wheel buttons

- ▶ Press the or button repeatedly until the standard display is shown.

Displaying the coolant temperature



Using the steering wheel buttons

- ▶ Press the or button repeatedly until the standard display is shown.
- ▶ Press the or button to select the coolant temperature.

The temperature displayed may climb to 250 °F (120 °C) when the vehicle is being driven in normal conditions and if the coolant contains the correct concentration of corrosion inhibitor and antifreeze. At high outside temperatures and when driving in mountainous terrain, the coolant temperature may rise to the end of the scale.

Audio menu

General notes

Use the functions in the **Audio** menu to operate the audio equipment when switched on.

- ① Operation of the audio equipment using the steering wheel buttons and making settings using the **AUDIO** menu only function with Sprinter audio equipment. If you are using audio equipment from another manufacturer, the described functions may be restricted or not available at all.

If no audio equipment is switched on, you will see the message **AUDIO off**.

Selecting a radio station

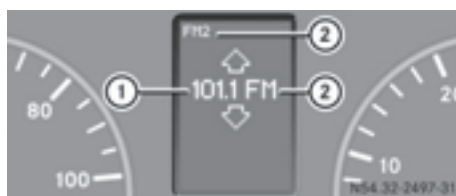

- ① Reception frequency
- ② Waveband or waveband with memory preset number

Using the steering wheel buttons

- ▶ Switch on the audio equipment (see the separate operating instructions).
- ▶ Press the or button repeatedly until the station selected appears in the display.
- ▶ Press the or button to select the desired station.

- ① You can only store new stations on the audio system itself. See the separate operating instructions.





You can also operate the audio equipment in the same way as usual.

Operating the CD player



- ① Current CD (with CD changer)
- ② Current track

Using the steering wheel buttons

- ▶ Switch on the audio equipment and select the CD player (see the separate operating instructions).
- ▶ Press the  or  button repeatedly until the settings for the current CD appear in the display.
- ▶ Press the  or  button to select a CD track.

Settings menu

Introduction

In the **Settings** menu, the following options and submenus are available:

- Resetting all settings
- Resetting the functions of a submenu
- Instrument cluster (▷ page 169)
 - Units and language settings
 - Status bar settings
- Time (▷ page 171)
- Lighting (▷ page 171)
 - Switching surround lighting on/off
 - Switching the daytime running lamps on/off
 - Setting the exterior lighting delayed switch-off
 - Activating/deactivating Highbeam Assist
- Vehicle
 - Setting the radio station selection
 - Setting the windshield wiper sensitivity
- Stationary heating or auxiliary heating (▷ page 108)
- Convenience (▷ page 173)
 - Key-dependent settings

- ❗ For safety reasons, it is not possible to reset all of the functions while the vehicle is in motion. For example, in the **Lighting** submenu, the **Daytime runn. lamps** function remains unchanged.



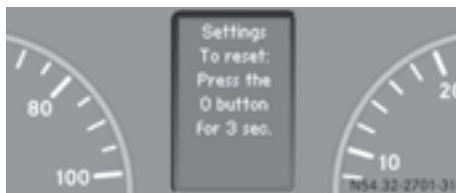

Resetting all settings



Settings menu

When the **Settings** message is displayed, you can reset all functions of the submenu to the factory settings.

Using the steering wheel buttons





- ▶ Press the  or  button repeatedly until the **Settings** menu appears in the display.
- ▶ Press and hold the  reset button for approximately 3 seconds. You will see a message in the display prompting you to press the  reset button again to confirm.
- ▶ Press the  reset button again. The functions in all submenus are reset to the factory settings.





- ❗ If you want to retain the settings, do not press the  reset button a second time. The **Settings** menu appears again after approximately 5 seconds.

Resetting the functions of a submenu

You can individually reset the functions of each submenu to the factory settings.

Using the steering wheel buttons

- ▶ Press the  or  button repeatedly until the **Settings** menu appears in the display.
- ▶ Press the  button to switch to the submenu selection.
- ▶ Press the  or  button to select a submenu.









- ▶ Press and hold the  reset button for approximately 3 seconds.
You will see a message in the display prompting you to press the  reset button again to confirm.
 - ▶ Press the  reset button again.
All functions in the submenu are reset to the factory settings.
- i** If you want to retain the settings, do not press the  reset button a second time. The **Settings** menu appears again after approximately 5 seconds.

Selecting submenus



You will see the collection of submenus. There are more submenus than can be displayed at the same time.

Using the steering wheel buttons









- ▶ Press the  or  button repeatedly until the **Settings** menu appears in the display.
- ▶ Press the  button to switch to the submenu selection.
- ▶ Press the  or  button to select a submenu.
The submenu currently selected is highlighted.
- ▶ Press the  button to select the function within a submenu.
- ▶ Change the setting by pressing the  or  button.
The changed setting is saved.

Instrument cluster submenu

Selecting the unit for temperature











Using the steering wheel buttons

- ▶ Press the  or  button repeatedly until the **Settings** menu appears in the display.
- ▶ Press the  button to switch to the submenu selection.
- ▶ Press the  or  button to select the **Inst. cluster** submenu.
- ▶ Press the  button to select the **Temperat.** function.
The selection marker is on the current setting.
- ▶ Press the  or  button to select the unit for all messages in the display: **°C** (degrees Celsius) or **°F** (degrees Fahrenheit).

Selecting the unit for the digital speedometer



Using the steering wheel buttons

- ▶ Press the  or  button repeatedly until the **Settings** menu appears in the display.
- ▶ Press the  button to switch to the submenu selection.
- ▶ Press the  or  button to select the **Inst. cluster** submenu.
- ▶ Press the  button to select the **Dig. speedo.** function.
The selection marker is on the current setting.
- ▶ Press the  or  button to select the unit for the digital speedometer: **km/h** or **mph**.

Selecting the unit for distance



Using the steering wheel buttons

- ▶ Press the or button repeatedly until the **Settings** menu appears in the display.
- ▶ Press the button to switch to the sub-menu selection.
- ▶ Press the or button to select the **Inst. cluster** submenu.
- ▶ Press the button to select the **Trip** function.
The selection marker is on the current setting.
- ▶ Press the or button to select the unit for all messages in the display: **km** (kilometers) or **miles**.

Selecting the language



The selected range of languages shown is just an example. The range of languages available is specific to each country.

Using the steering wheel buttons

- ▶ Press the or button repeatedly until the **Settings** menu appears in the display.
- ▶ Press the button to switch to the sub-menu selection.
- ▶ Press the or button to select the **Inst. cluster** submenu.
- ▶ Press the button to select the **Language** function.
The selection marker is on the current setting.
- ▶ Press the or button to set the language for all messages.

Selecting the display for the status bar



Using the steering wheel buttons

- ▶ Press the or button repeatedly until the **Settings** menu appears in the display.
- ▶ Press the button to switch to the sub-menu selection.
- ▶ Press the or button to select the **Inst. cluster** submenu.
- ▶ Press the button to select the **Select disp.** function.
The selection marker is on the current setting.
- ▶ Press the or button to select whether to display the outside temperature or the speed (digital speedometer).
The selected display is then shown permanently in the lower part of the display.

Selecting the unit for the tire pressure



Using the steering wheel buttons

- ▶ Press the or button repeatedly until the **Settings** menu appears in the display.
- ▶ Press the button to switch to the sub-menu selection.
- ▶ Press the or button to select the **Inst. cluster** submenu.
- ▶ Press the button to select the **Tire pres.** function.
The selection marker is on the current setting.
- ▶ Press the or button to select the unit for the tire pressure in the display: **bar** or **psi**.

Clock/Date submenu

Setting the time



Using the steering wheel buttons

- ▶ Press the or button repeatedly until the **Settings** menu appears in the display.
- ▶ Press the button to switch to the submenu selection.
- ▶ Press the or button to select the **Clock/Date** submenu.
- ▶ Press the button to select **Set clock Hours** or **Minutes**.
- ▶ Press the or button to set the values.

Selecting the time format



Using the steering wheel buttons

- ▶ Press the or button repeatedly until the **Settings** menu appears in the display.
- ▶ Press the button to switch to the submenu selection.
- ▶ Press the or button to select the **Clock/Date** submenu.
- ▶ Press the button to select the **12/24 h** function. The selection marker is on the current setting.
- ▶ Press the or button to select the **12 h** or **24 h** clock format.

Lighting submenu

Activating/deactivating Highbeam Assist

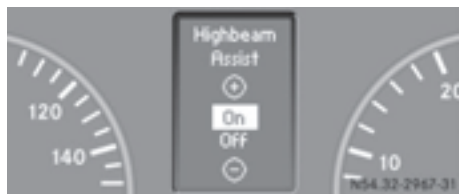

Using the steering wheel buttons

- ▶ Press the or button repeatedly until the **Settings** menu appears in the display.
- ▶ Press the button to switch to the submenu selection.
- ▶ Press the or button to select the **Lighting** submenu.
- ▶ Press the button to select the **Highbeam Assist** function. The selection marker is on the current setting.
- ▶ Press the or button to switch Highbeam Assist **On** or **Off**.

i For safety reasons, it is not possible to reset the **Highbeam Assist** function to the factory settings during a journey. You will see the following message in the display: **Setting only possible at standstill**.

For further information about Highbeam Assist, see (▶ page 83).











Switching the daytime running lamps on/off



If you switch the daytime running lamps function to **On**, the daytime running lamps will automatically light up when the engine is running.

For safety reasons, it is only possible to change this setting when the vehicle is stationary. The factory setting is **On** in countries in which daytime running lamp mode or daytime running lamps are mandatory.

Using the steering wheel buttons









- ▶ Press the  or  button repeatedly until the **Settings** menu appears in the display.
 - ▶ Press the  button to switch to the sub-menu selection.
 - ▶ Press the  or  button to select the **Lighting** submenu.
 - ▶ Press the  button to select the **Daytime runn. lamps** function.
The selection marker is on the current setting.
 - ▶ Press the  or  button to switch the daytime running lamps **On** or **Off**.
- i** If you turn the light switch to  or , the corresponding lamp switches on. If you turn the light switch to **Auto**, the daytime running lamps remain switched on.

- i** For safety reasons, it is not possible to reset the **Daytime runn. lamps** function to the factory setting while the vehicle is in motion. You will see the following message in the display: **Setting only possible at standstill.**

Switching surround lighting on or off



Using the steering wheel buttons

- ▶ Press the  or  button repeatedly until the **Settings** menu appears in the display.
- ▶ Press the  button to switch to the sub-menu selection.
- ▶ Press the  or  button to select the **Lighting** submenu.
- ▶ Press the  button to select the **Loc. lighting** function.
The selection marker is on the current setting.
- ▶ Press the  or  button to switch the surround lighting **On** or **Off**.

If you switch the surround lighting to **On**, the following lamps light up in the dark after you have unlocked the vehicle using the key:

- the parking lamps
- the tail lamps
- the license plate lamps
- the fog lamps

The surround lighting automatically switches off after 40 seconds or if you:









- open the driver's door
- insert the key into the ignition lock
- lock the vehicle using the key

Setting the exterior lighting delayed switch-off



In the **Headlamps** submenu, you can set whether and for how long you wish the exterior lighting to remain on after closing the doors.

Using the steering wheel buttons

- ▶ Press the  or  button repeatedly until the **Settings** menu appears in the display.
- ▶ Press the  button to switch to the sub-menu selection.
- ▶ Press the  or  button to select the **Lighting** submenu.
- ▶ Press the  button to select the **Headlamps** function.
The selection marker is on the current setting.
- ▶ Press the  or  button to select whether and for how long you wish the exterior lighting to remain on.

If you have set the delayed switch-off and switch off the engine, the following remain lit:

- the parking lamps
- the tail lamps
- the license plate lamps
- the fog lamps

- i** You can reactivate this function by opening a door within 10 minutes.

If, after switching off the engine, you do not open a door or you close an open door, the exterior lighting switches off after 60 seconds.

Vehicle submenu

Setting the windshield wiper sensitivity



You can use the **Wipe sensor** function to set the sensitivity of the rain/ light sensor.

Using the steering wheel buttons

- ▶ Press the or button repeatedly until the **Settings** menu appears in the display.
- ▶ Press the button to switch to the submenu selection.
- ▶ Press the or button to select the **Vehicle** submenu.
- ▶ Press the button to select the **Wipe sensor** function. The selection marker is on the current setting.
- ▶ Press the or button to adjust the sensitivity of the rain/light sensor.

The levels are graded as follows:

- **Level 1**: high sensitivity – wiping begins even in light rain
- **Level 2**: moderate sensitivity
- **Level 3**: low sensitivity – wiping only begins in heavy rain

Activating/deactivating Blind Spot Assist



Using the steering wheel buttons

- ▶ Press the or button repeatedly until the **Settings** menu appears in the display.
- ▶ Press the button to switch to the submenu selection.
- ▶ Press the or button to select the **Vehicle** submenu.

- ▶ Press the button to select the **Blind Spot Assist** function. The selection marker is on the current setting.
- ▶ Press the or button to switch Blind Spot Assist **On** or **Off**.

For further information about Blind Spot Assist; see (> page 144).

Heating submenu

Selecting the switch-on time for the auxiliary heating



Using the steering wheel buttons

- ▶ Press the or button repeatedly until the **Settings** menu appears in the display.
- ▶ Press the button to switch to the submenu selection.
- ▶ Press the or button to select the **Heating** submenu.
- ▶ Press the button to switch to the **Aux. heat.** submenu selection (> page 108). The selection marker is on the current setting.
- ▶ Press the or button to set the desired switch-on time. Use the **Timer off** setting to deactivate automatic switch-on.
- ▶ Press button . The switch-on time is selected.









Convenience submenu



The **Key** function allows you to define whether settings for some submenus are stored with a key dependence.

This function pertains to the **Inst. cluster** (instrument cluster) menu, the **Lighting** menu and the **Vehicle** menu.

Using the steering wheel buttons

- ▶ Press the  or  button repeatedly until the **Settings** menu appears in the display.
- ▶ Press the  button to switch to the submenu selection.
- ▶ Press the  or  button to select the **Convenience** submenu.
- ▶ Press the  button to select the **Key** function. The selection marker is on the current setting.
- ▶ Press the  or  button to activate or deactivate key dependency.

Trip computer menu

General notes

You can call up or reset statistical data for the vehicle in the **Trip computer** menu.

- i** When you call up the trip computer again, it displays the last function called up.

The units of the statistical information displayed are set permanently for each specific country, and are therefore independent of the units selected in the **Settings** menu.



Trip computer "After start" or "After reset"



Example: "After start" trip computer

- ① Distance
- ② Time
- ③ Average speed
- ④ Average fuel consumption

Using the steering wheel buttons

- ▶ Press the  or  button to select **After start**.

or

- ▶ Press the  or  button to select **After reset**.

The values in the **After start** submenu refer to the start of the journey. The values in the **After reset** submenu refer to the last reset of the trip computer.

The **After start** trip computer function is automatically reset if:

- the ignition has been switched off for more than 4 hours.
- 999 hours have been exceeded.
- 9,999 miles have been exceeded.



The **After reset** trip computer is automatically reset if the value exceeds 9,999 hours or 99,999 miles.

- i** If you turn the key to position **0** in the ignition lock or remove it, all the values are reset after approximately four hours.

The values will not be reset if you turn the key back to position **1** or **2** during this time.

Calling up the range

Using the steering wheel buttons

- ▶ Press the  or  button to select **After start**.

- ▶ Press the  or  button to select **Range**.

The approximate distance which can be covered with the tank's current contents and your current style of driving is shown.

- i** If there is only a small amount of fuel left in the fuel tank, the  **Please refuel** message is shown instead of the range.

Resetting the trip computer

Using the steering wheel buttons

- ▶ Press the  or  button to select **After start**.

- ▶ Press the  or  button to select the function you would like to reset.

- ▶ Press and hold the  reset button until the values are reset to "0".

Telephone menu

Introduction



WARNING

If you operate information systems and communication equipment integrated in the vehicle while driving, you will be distracted from traffic conditions. You could also lose control of the vehicle. There is a risk of an accident.

Only operate the equipment when the traffic situation permits. If you are not sure that this is possible, park the vehicle paying attention to traffic conditions and operate the equipment when the vehicle is stationary.

You must observe the legal requirements of the country in which you are currently driving when operating a mobile phone in the vehicle. If it is permitted to operate a mobile phone while the vehicle is in motion, only operate it when road and traffic conditions permit.

If you have connected a mobile phone to the Sprinter hands-free system, you can operate it using the functions in the **TEL** menu.

- ▶ Switch on the mobile phone (see the separate operating instructions).
- ▶ Switch on the audio equipment (see the separate operating instructions).
- ▶ Establish a Bluetooth® connection between the mobile phone and the audio equipment (see the separate operating instructions).
- ▶ Press the  or  button on the steering wheel to select the **TEL** menu.
- ▶ When **Please enter PIN:** appears in the display, enter the PIN using the mobile phone or audio equipment.
The mobile phone will search for a network. The display remains blank during this time. You will see the mobile phone operational readiness display once the mobile phone has found a network.

i You can obtain further information about suitable mobile phones and connecting mobile phones via Bluetooth® at any qualified specialist workshop.

i If the mobile phone operational readiness symbol goes out, your vehicle is outside of the transmission and reception range.

Accepting a call

- ▶ Press the  button on the steering wheel to accept an incoming call.
The display shows the call duration.







Rejecting or ending a call

- ▶ Press  button on the steering wheel to reject or end a call.
The caller then hears the engaged tone.
The display shows the mobile phone operational readiness symbol again.



Dialing a number from the phone book

You can enter new telephone numbers into the phone book via the mobile phone (see the separate operating instructions). If your mobile phone is able to receive calls, you can search for and dial a number from the phone book.



Using the steering wheel buttons

- ▶ Use the  or  button to select the **TEL** menu.
The display shows the mobile phone operational readiness symbol.
- ▶ Press the  or  button to switch to the phone book.
The on-board computer reads the phone book stored on the SIM card or in the mobile phone. This may take more than a minute.
When the message is no longer displayed, reading has ended.
- ▶ Press the  or  button to select the desired name.

or

- ▶ **To start rapid scrolling:** press and hold the  or  button longer than 1 second. Rapid scrolling stops when you release the button or reach the end of the list.

Using the steering wheel buttons

- ▶ **To start dialing:** press the  button.
The on-board computer dials the corresponding phone number.
When a connection is established, the name of the other person and/or the call duration appear in the display.
- ▶ **To exit the phone book:** press the  button.





Redialing

The on-board computer saves the last names or numbers dialed in the redial memory.

Using the steering wheel buttons

- ▶ Use the  or  button to select the **TEL** menu.

The display shows the mobile phone operational readiness symbol.

- ▶ Press the  button.
The display shows the most recently dialed numbers or names in the redial memory.
- ▶ Press the  or  button to select the desired name or number.
- ▶ **To start dialing:** press the  button.
The on-board computer dials the corresponding phone number.

When a connection is established, the name of the other person and/or the call duration appear in the display.

or

- ▶ **To exit the redial memory:** press the  button.

Display messages

Notes on display messages

Important safety notes

WARNING

No information will be displayed if either the instrument cluster or the display is inoperative.

As a result, you will not be able to see warning and indicator lamps or information about the driving conditions, such as speed or outside temperature. Driving characteristics may be impaired. Adjust your driving style and vehicle speed accordingly.

Contact a qualified specialist workshop immediately.

WARNING

If service work is not carried out correctly, the operating safety of your vehicle may be affected. This could cause you to lose control of your vehicle and cause an accident. More-

over, the safety systems may no longer be able to protect you or others as they are designed to do.

Always have service work carried out at a qualified specialist workshop.

- i** If you turn the key to position **2** in the ignition, a display check is performed. All warning and indicator lamps (except the turn signal indicator lamps) and the display are activated. Before starting the journey, check that the warning and indicator lamps are operating correctly.





Vehicles without steering wheel buttons

Warnings, malfunctions or additional information may also be shown in the display. The following tables show all the display messages. A warning tone sounds with certain display messages.

Vehicles with steering wheel buttons

The on-board computer shows warnings, malfunctions or additional information in the display. A warning tone sounds with certain display messages. Display messages of a high priority are shown in red.

Please respond in accordance with the display messages and follow the additional notes in this Operator's Manual.

You can hide low-priority display messages by pressing the , ,  or  button on the steering wheel or the  reset button.

You cannot hide display messages of the highest priority. These messages will continue to be shown in the display until their cause has been eliminated.







The on-board computer stores certain display messages in the message memory (> page 176).

Message memory

The on-board computer only records and shows malfunctions and warnings from certain systems. Therefore, make sure that your vehicle is safe to use. You could otherwise cause an accident by driving an unsafe vehicle.





The on-board computer stores certain display messages. In the **Message memory** menu, you can call up stored display messages.











Using the steering wheel buttons





- ▶ Press the  or  button repeatedly until the number of stored display messages, e.g. **2 messages**, appears in the display. If no malfunctions have occurred, the **No messages** message appears.
- ▶ Scroll through the stored display messages with the  or  button.
- ▶ **To exit the message memory menu:** press the  or  button.

When you switch off the ignition, all display messages are deleted from the message memory. You can only remove the key when it is in the basic position.

Display messages on vehicles without steering wheel buttons



Display messages	Possible causes/consequences and ► Solutions
	<p>The activation conditions for cruise control have not been met. You can only activate cruise control from speeds of 20 mph (30 km/h).</p> <p>or</p> <p>Cruise control has been deactivated due to a malfunction.</p> <p>► Have cruise control checked at a qualified specialist workshop.</p>
NO TPMS	<p>The NO message is displayed for 30 seconds. The TPMS message is also displayed after 30 seconds.</p> <p>The tire pressure monitor has malfunctioned.</p> <p>► Have the tire pressure monitor and the wheels checked at a qualified specialist workshop.</p>
NO TPMS	<p>The NO message is displayed for 30 seconds. The TPMS message is also displayed after 30 seconds.</p> <p>The tire pressure monitor is not receiving signals from one or more wheels because:</p> <ul style="list-style-type: none"> • a wheel has been replaced with the spare wheel without wheel electronics. • the maximum temperature on one of the wheel electronics units has been exceeded. • the wheel electronics are malfunctioning. <p>► Have wheels with suitable wheel electronics units installed at a qualified specialist workshop.</p>
-- TPMS	<p>The -- message is displayed for 30 seconds. The TPMS message is also displayed after 30 seconds.</p> <p>The pressure is insufficient in one or more tires, or the pressures of the individual tires differ significantly.</p> <p>► Check the tire pressure and correct it if necessary (▷ page 253).</p>
dEF Chk	<p>In addition, the yellow  DEF indicator lamp lights up in the instrument cluster and a warning tone sounds.</p> <p>The DEF supply has dropped below 1.5 US gal (5.5 l).</p> <p>► Add DEF supply (▷ page 129).</p> <p>The  DEF indicator lamp only disappears when the vehicle is stationary, at the latest after 20 seconds as soon as you switch on the ignition or start the engine after refueling.</p>
	<p>In addition, the yellow  Check Engine indicator lamp and the yellow  DEF indicator lamp light up in the instrument cluster and a warning tone sounds.</p> <p>The DEF reducing agent is contaminated, diluted or is not compliant with ISO 22241.</p> <p>► Have the DEF tank cleaned and refilled at a qualified specialist workshop as soon as possible.</p>







Display messages	Possible causes/consequences and ► Solutions
<p>StArtS RExx</p>	<p>In addition, the yellow  DEF indicator lamp lights up and a warning tone sequence sounds.</p> <p>The DEF supply has dropped below the 0.8 US gal (3.0 l) reserve mark. After the message appears for the first time, the remaining DEF supply will last for approximately 1200 miles (1900 km). The engine can then only be started another 16 times.</p> <p>The number of remaining engine starts XX (16 to 1) is shown in the message every time the engine is started.</p> <p>► Add at least 1.5 US gal (5.5 l) of DEF (▷ page 129). The  DEF indicator lamp disappears after no more than 20 seconds after the vehicle has stopped or you have switched on the ignition or started the engine after refueling.</p> <p>In addition, the yellow  Check Engine indicator lamp and the yellow  DEF indicator lamp light up in the instrument cluster and three short warning tones sound.</p> <p>The DEF reducing agent is contaminated, diluted or is not compliant with ISO 22241.</p> <p>The exhaust gas aftertreatment is malfunctioning or an emission relevant malfunction has occurred. This malfunction or defect can damage the exhaust gas aftertreatment.</p> <p>► Visit a qualified specialist workshop immediately.</p>
<p> StArtS IdLE</p>	<p>In addition, the yellow  DEF indicator lamp and the  Check Engine indicator lamp light up in the instrument cluster and three warning tones sound.</p> <p>If the StArtS IdLE message is displayed, you cannot drive the vehicle at a speed exceeding 5 mph (8 km/h).</p> <p>► Add at least 1.5 US gal (5.5 l) of DEF (▷ page 129). The  DEF indicator lamp disappears after no more than 20 seconds after the vehicle has stopped or you have switched on the ignition or started the engine after refueling.</p> <p>In addition, the yellow  Check Engine indicator lamp and the yellow  DEF indicator lamp light up in the instrument cluster and a warning tone sounds.</p> <p>You cannot drive the vehicle at a speed exceeding 5 mph (8 km/h).</p> <p>► Visit a qualified specialist workshop immediately.</p>







Display messages	Possible causes/consequences and ► Solutions
Err	<p>flashes for 5 seconds, in addition the  indicator lamp flashes in the instrument cluster and then lights up yellow continuously. Lane Keeping Assist is deactivated and temporarily inoperative. Possible causes are:</p> <ul style="list-style-type: none"> • There are no lane markings present. • The camera's functionality is impaired due to heavy rain, snow or fog. • The camera cannot recognize the road markings: <ul style="list-style-type: none"> - It is too dark. - The lane markings are worn or are covered, for example, by dirt or snow. • The windshield is dirty in the camera's field of vision. <p>► Stop the vehicle paying attention to road and traffic conditions. ► Secure the vehicle to prevent it from rolling away (► page 130). ► Clean the windshield (► page 235), particularly in the camera's field of vision.</p> <p>If the  indicator lamp goes out, Lane Keeping Assist is operational again.</p> <p>If the problem persists, visit a qualified specialist workshop.</p>
Err	<p>flashes for 5 seconds, the  indicator lamp also flashes and then goes out. Highbeam Assist is deactivated and temporarily not operational or Highbeam Assist is malfunctioning. Possible causes are:</p> <ul style="list-style-type: none"> • The camera's functionality is impaired due to heavy rain, snow or fog. • The windshield is dirty in the camera's field of vision. <p>► Stop the vehicle paying attention to road and traffic conditions. ► Secure the vehicle to prevent it from rolling away (► page 130). ► Clean the windshield (► page 235), particularly in the camera's field of vision.</p> <p>If the  indicator lamp goes out, Highbeam Assist is operational again.</p> <p>If the problem persists, visit a qualified specialist workshop.</p>
Blind_Err	<p>flashes for 5 seconds, the yellow indicator lamps flash in the exterior mirrors and then light up constantly. Blind Spot Assist is faulty.</p> <p>► Visit a qualified specialist workshop.</p>
Err	<p>flashes for 5 seconds, the  indicator lamp also flashes and then lights up constantly. COLLISION PREVENTION ASSIST is malfunctioning.</p> <p>► Visit a qualified specialist workshop.</p>







Display messages on vehicles with steering wheel buttons

Safety systems









Display messages	Possible causes/consequences and ► Solutions
<p>ABS Visit workshop</p>	<p>ABS has been deactivated due to a malfunction. ESP[®], ASR and BAS, as well as cruise control, have also been deactivated as a result.</p> <p> WARNING</p> <p>The brake system continues to function normally, but without the functions listed above. The wheels could therefore lock if you brake hard, for example.</p> <p>This causes steerability and braking to be greatly impaired. The braking distance can increase in emergency braking situations. The driven wheels can spin when accelerating.</p> <p>If ESP[®] is not operational, ESP[®] will not stabilize the vehicle. There is an increased risk of skidding and accidents.</p> <ul style="list-style-type: none"> ► Drive on with care. ► Visit a qualified specialist workshop immediately.
<p>ABS Unavailable</p>	<p>ABS is temporarily unavailable or is deactivated due to undervoltage. ESP[®], ASR and BAS, as well as cruise control, are also unavailable as a result.</p> <p>The battery may not be being charged.</p> <p> WARNING</p> <p>The brake system continues to function normally, but without the functions listed above. The wheels could therefore lock if you brake hard, for example.</p> <p>This causes steerability and braking to be greatly impaired. The braking distance can increase in emergency braking situations. The driven wheels can spin when accelerating.</p> <p>If ESP[®] is not operational, ESP[®] will not stabilize the vehicle. There is an increased risk of skidding and accidents.</p> <ul style="list-style-type: none"> ► Drive for a short distance at a speed of more than 13 mph (20 km/h). If the display message disappears, the functions mentioned above are available again. <p>If the display message continues to be displayed:</p> <ul style="list-style-type: none"> ► Drive on with care. ► Visit a qualified specialist workshop immediately.

Display messages	Possible causes/consequences and ► Solutions
 Visit workshop	<p>ASR has been deactivated due to a malfunction. The engine power output may be reduced.</p> <p> WARNING</p> <p>The driven wheels can spin when accelerating. There is an increased risk of skidding and accidents.</p> <ul style="list-style-type: none"> ► Drive on with care. ► Visit a qualified specialist workshop immediately.
 Visit workshop	<p>BAS has been deactivated due to a malfunction.</p> <p> WARNING</p> <p>The brake system continues to function normally, but without electronic support. The braking distance can increase in emergency braking situations. There is a risk of an accident.</p> <ul style="list-style-type: none"> ► Drive on with care. ► Visit a qualified specialist workshop immediately.
 Unavailable	<p>ASR and BAS have been deactivated due to undervoltage. The battery may not be being charged.</p> <p> WARNING</p> <p>The brake system continues to function normally, but without the functions listed above. The wheels could therefore lock if you brake hard, for example. The braking distance can increase in emergency braking situations. The driven wheels can spin when accelerating. There is an increased risk of skidding and accidents.</p> <ul style="list-style-type: none"> ► Drive on with care. ► Visit a qualified specialist workshop immediately.
 Brake wear Visit workshop	<p>The brake pads/linings have reached their wear limit.</p> <ul style="list-style-type: none"> ► Have the brake pads/linings replaced as soon as possible at a qualified specialist workshop.













Display messages	Possible causes/consequences and ► Solutions
 <p>Brake fluid Visit workshop</p>	<p>There is insufficient brake fluid in the fluid reservoir.</p> <p> WARNING</p> <p>Braking performance can be impaired. There is a risk of an accident.</p> <ul style="list-style-type: none"> ► Stop the vehicle as soon as possible, paying attention to road and traffic conditions. ► Check the brake fluid level in the brake fluid reservoir (► page 223). <p>If the brake fluid is below the MIN mark:</p> <ul style="list-style-type: none"> ► Do not continue driving under any circumstances. ► Do not add brake fluid. This does not solve the problem. ► Consult a qualified specialist workshop. <p>If the brake fluid is above the MIN mark:</p> <ul style="list-style-type: none"> ► Drive on with care. ► Visit a qualified specialist workshop immediately.
 <p>Brake force distribution</p>	<p>EBD has been deactivated due to undervoltage. The battery may not be being charged.</p> <p> WARNING</p> <p>The rear wheels could lock when you apply the brakes. The braking distance can increase in emergency braking situations. There is an increased risk of skidding and accidents.</p> <ul style="list-style-type: none"> ► Stop the vehicle as soon as possible, paying attention to road and traffic conditions. ► Do not drive on. ► Consult a qualified specialist workshop.
 <p>Brake force distribution Visit workshop</p>	<p>EBD has been deactivated due to a malfunction.</p> <p> WARNING</p> <p>The rear wheels could lock when you apply the brakes. The braking distance can increase in emergency braking situations. There is an increased risk of skidding and accidents.</p> <ul style="list-style-type: none"> ► Stop the vehicle as soon as possible, paying attention to road and traffic conditions. ► Do not drive on. ► Consult a qualified specialist workshop.

Display messages	Possible causes/consequences and ► Solutions
ESP Visit workshop	ESP® has been deactivated due to a malfunction. As a result, cruise control has also been deactivated. Engine power output may be reduced.  WARNING If ESP® is not operational, ESP® will not stabilize the vehicle. There is an increased risk of skidding and accidents. ► Drive on with care. ► Visit a qualified specialist workshop immediately.
ESP Unavailable	ESP® has been deactivated due to undervoltage. As a result, cruise control has also been deactivated. The battery may not be being charged.  WARNING If ESP® is not operational, ESP® will not stabilize the vehicle. There is an increased risk of skidding and accidents. ► Drive on with care. ► Consult a qualified specialized workshop as soon as possible.
 Parking brake Release brake	Additionally, a warning tone sounds. You are driving with the parking brake applied. ► Release the parking brake (▷ page 131).
 Seatbelt sys. Visit workshop	The belt system has malfunctioned.  WARNING In the event of an accident or a rapid deceleration, the seat belts either cannot protect you as intended. There is a risk of injury. ► Consult a qualified specialized workshop as soon as possible.
 Restraint system Visit workshop	The restraint system is faulty.  WARNING If the restraint system is malfunctioning, individual systems could be triggered inadvertently or might not be triggered at all in the event of an accident. There is an increased risk of injury and accidents. ► Drive on with care. ► Visit a qualified specialist workshop immediately.

Lights

Display messages	Possible causes/consequences and ► Solutions
 Low beam left	The left-hand low beam is faulty ³ . <ul style="list-style-type: none"> ► Halogen headlamps: replace the bulb as soon as possible (▷ page 87). ► Bi-Xenon headlamps: consult a qualified specialist workshop as soon as possible.
 Low beam right	The right-hand low-beam headlamp is faulty ³ . <ul style="list-style-type: none"> ► Halogen headlamps: replace the bulb as soon as possible (▷ page 87). ► Bi-Xenon headlamps: consult a qualified specialist workshop as soon as possible.
 Cornering lt. left	The left-hand cornering light is faulty ³ . <ul style="list-style-type: none"> ► Replace the bulb as soon as possible (▷ page 87).
 Cornering lt. right	The right-hand cornering light is faulty ³ . <ul style="list-style-type: none"> ► Replace the bulb as soon as possible (▷ page 87).
 Lights on auto- matic. Remove key	The automatic headlamp feature is active: the light switch is in the AUTO position and you have forgotten to remove the key. <ul style="list-style-type: none"> ► Remove the key from the ignition lock.
 Turn signal left	The left-hand turn signal is faulty. <ul style="list-style-type: none"> ► Change the bulb as soon as possible in the front (▷ page 88) or rear (▷ page 89) indicator lamp.
 Turn signal right	The right-hand turn signal is faulty. <ul style="list-style-type: none"> ► Change the bulb as soon as possible in the front (▷ page 88) or rear (▷ page 89) indicator lamp.
 Brake lamp left	The left brake lamp is faulty ³ . <ul style="list-style-type: none"> ► Replace the bulb as soon as possible (▷ page 89).
 Brake lamp right	The right brake lamp is faulty ³ . <ul style="list-style-type: none"> ► Replace the bulb as soon as possible (▷ page 89).
 Third brake lamp	The high-mounted brake lamp is faulty ³ . This display message will only appear if all LEDs have failed. <ul style="list-style-type: none"> ► Consult a qualified specialized workshop as soon as possible.
 High beam left	The left high-beam headlamp is faulty ³ . <ul style="list-style-type: none"> ► Replace the bulb as soon as possible (▷ page 87).

³ Depending on the equipment, the bulb-failure indicator may not be featured for any lamps other than the turn signals.









Display messages	Possible causes/consequences and ► Solutions
 High beam right	The right high beam headlamp is faulty ³ . ► Replace the bulb as soon as possible (▷ page 87).
 License plate lamp	A license plate lamp is faulty ³ . ► Replace the bulb as soon as possible (▷ page 90).
 Switch off lights	You have forgotten to switch off the lights when leaving the vehicle. ► Turn the light switch to <input type="text" value="0"/> .
 Foglamp front left	The left-hand front fog lamp is faulty ³ . ► Have the bulb replaced as soon as possible at a qualified specialist workshop.
 Foglamp front right	The right-hand front fog lamp is faulty ³ . ► Have the bulb replaced as soon as possible at a qualified specialist workshop.
 Rear foglamp	The rear fog lamp is faulty ³ . ► Replace the bulb as soon as possible (▷ page 89).
 Parking lamp front left	The front left parking lamp/standing lamp is faulty ³ . ► Replace the bulb as soon as possible (▷ page 87).
 Parking lamp front right	The front right parking lamp/standing lamp is faulty ³ . ► Replace the bulb as soon as possible (▷ page 87).
 Reverse lamp	A backup lamp is faulty ³ . ► Replace the bulb as soon as possible (▷ page 89).
 Tail lamp left	The left-hand tail lamp is faulty ³ . ► Replace the bulb as soon as possible (▷ page 89).
 Tail lamp right	The right-hand tail lamp is faulty ³ . ► Replace the bulb as soon as possible (▷ page 89).
 Marker lamp	A perimeter lamp is faulty ³ . ► Replace the bulb as soon as possible (▷ page 91).







³ Depending on the equipment, the bulb-failure indicator may not be featured for any lamps other than the turn signals.



Display messages	Possible causes/consequences and ► Solutions
Highbeam Assist inoperative	Highbeam Assist is faulty. ► Visit a qualified specialist workshop.
Highbeam Assist temporarily unavailable	Highbeam Assist is deactivated and temporarily inoperative. Possible causes are: <ul style="list-style-type: none"> • The camera's functionality is impaired due to heavy rain, snow or fog. • The windshield is dirty in the camera's field of vision. ► Stop the vehicle paying attention to road and traffic conditions. ► Secure the vehicle to prevent it from rolling away (▷ page 130). ► Clean the windshield (▷ page 235), particularly in the camera's field of vision. If the malfunction has been rectified, the Highbeam Assist available again message appears.

Engine



Display messages	Possible causes/consequences and ► Solutions
Exhaust Filter: Drive at high engine speed. See Oper. Manual	The automatic regeneration of the diesel particle filter is not sufficient or has malfunctioned. ► Drive at an engine speed of above 2000 rpm until the display message disappears. If the display message does not go out after approximately 20 minutes, have the malfunction rectified immediately at a qualified specialist workshop.
Check Diesel Exhaust Fluid See Operator's Manual	The DEF supply has dropped below 1.5 US gal (5.5 l). ► Add DEF supply (▷ page 129). The display message only disappears when the vehicle is stationary, at the latest after 20 seconds as soon as you switch on the ignition or start the engine after refueling.
 XX starts remaining	Three short warning tones also sound. After the message appears for the first time, the remaining DEF supply will last for approximately 1200 miles (1900 km). The engine can then only be started another 16 times. The number of remaining engine starts xx (16 to 0) is shown in the message every time the engine is started. ► Add at least 1.5 US gal (5.5 l) of DEF (▷ page 129).

Display messages	Possible causes/consequences and ► Solutions
 <p>Idle Mode</p>	<p>The yellow  Check Engine indicator lamp also lights up and three short warning tones sound.</p> <p>You cannot drive the vehicle at a speed exceeding 5 mph (8 km/h).</p> <p>► Add at least 1.5 US gal (5.5 l) of DEF (► page 129).</p> <p>The display message and the yellow  Check Engine indicator lamp only disappear when the vehicle is stationary, at the latest after 20 seconds as soon as you switch on the ignition or start the engine after refueling.</p>
<p>Check Diesel Exhaust Fluid See Operator's Manual</p>	<p>In addition, the yellow  DEF indicator lamp lights up and a warning tone sounds.</p> <p>The DEF reducing agent is contaminated, diluted or is not compliant with ISO 22241.</p> <p>► Have the DEF tank cleaned and refilled at a qualified specialist workshop as soon as possible.</p>
 <p>XX starts remaining</p>	<p>The yellow  Check Engine indicator lamp also lights up and three short warning tones sound.</p> <p>After the message appears for the first time, the remaining DEF supply will last for approximately 1200 miles (1900 km). The engine can then only be started another 16 times.</p> <p>The number of remaining engine starts xx (16 to 0) is shown in the message every time the engine is started.</p> <p>The DEF reducing agent is contaminated, diluted or is not compliant with ISO 22241.</p> <p>The exhaust gas aftertreatment is malfunctioning or an emission relevant malfunction has occurred. This malfunction or defect can damage the exhaust gas aftertreatment.</p> <p>► Visit a qualified specialist workshop immediately.</p>
 <p>Idle Mode</p>	<p>The yellow  DEF indicator lamp also lights up and three short warning tones sound.</p> <p>The vehicle cannot be driven at a speed exceeding 5 mph (8 km/h).</p> <p>► Visit a qualified specialist workshop immediately.</p>
 <p>Coolant Stop, turn engine off</p>	<p>The coolant temperature is too high.</p> <p>If the vehicle is stopped after being subjected to extreme loads, the coolant warning lamp may come on when the ignition is switched on or the engine is restarted. Such loads can be, for example, driving in mountainous terrain or driving with a trailer.</p> <p>► Run the engine for approximately 1 minute at idling speed.</p> <p>► Consult a qualified specialist workshop if the display message continues to be shown.</p>

Display messages	Possible causes/consequences and ► Solutions
 <p data-bbox="116 220 344 245">Coolant Check Level</p>	<p data-bbox="371 172 642 197">The coolant level is too low.</p> <p data-bbox="371 201 1034 252">Never run the engine if the coolant level is too low. The engine could overheat and be damaged.</p> <ul style="list-style-type: none"> <li data-bbox="371 261 1034 312">► Stop the vehicle as soon as possible, paying attention to road and traffic conditions. <li data-bbox="371 319 801 344">► Switch off the engine and let it cool down. <li data-bbox="371 351 920 402">► Add coolant and be sure to observe the warning notes (► page 283). <li data-bbox="371 408 1034 459">► If you need to add coolant frequently, have the engine cooling system checked at a qualified specialist workshop.
 <p data-bbox="116 526 336 577">Reserve fuel Drive to a gas station</p>	<p data-bbox="371 478 822 504">The fuel level has fallen into the reserve range.</p> <ul style="list-style-type: none"> <li data-bbox="371 510 848 536">► Refuel at the nearest gas station (► page 127).
 <p data-bbox="116 646 344 697">Water in fuel Visit workshop</p>	<p data-bbox="371 598 1034 649">The water that has collected in the water separator has reached the maximum level.</p> <ul style="list-style-type: none"> <li data-bbox="371 655 781 681">► Drain the water separator (► page 224).
 <p data-bbox="116 766 322 817">Fuel filter Visit workshop</p>	<p data-bbox="371 718 577 743">The fuel filter is dirty.</p> <ul style="list-style-type: none"> <li data-bbox="371 750 1034 801">► Have the fuel filter element replaced as soon as possible at a qualified specialist workshop.
 <p data-bbox="116 885 336 959">Engine oil Add 1.0 quart(Canada: 1.0 liter)</p>	<p data-bbox="371 837 591 863">The oil level is too low.</p> <ul style="list-style-type: none"> <li data-bbox="371 869 1034 920">► Check the oil level the next time you refuel (► page 220), and add oil.
 <p data-bbox="116 1021 336 1104">Engine oil level Not when eng. running</p>	<p data-bbox="371 973 1034 1024">You want to check the engine oil level even though the engine is still running.</p> <ul style="list-style-type: none"> <li data-bbox="371 1031 607 1056">► Switch off the engine. <li data-bbox="371 1062 712 1088">► Check the oil level (► page 220).
 <p data-bbox="116 1165 309 1216">Engine oil level Reduce oil level</p>	<p data-bbox="371 1117 1034 1168">You have added too much engine oil. There is a risk of damaging the engine or catalytic converter.</p> <ul style="list-style-type: none"> <li data-bbox="371 1174 712 1200">► Check the oil level (► page 220). <li data-bbox="371 1206 1034 1257">► If the oil level is too high: have the engine oil extracted at the next qualified specialist workshop. <li data-bbox="371 1264 1034 1315">► If the oil level is correct: have the malfunction rectified at the next qualified specialist workshop.

Display messages	Possible causes/consequences and ► Solutions
 <p>Engine oil level Stop, turn engine off</p>	<p>There is not enough or no oil in the engine. There is a danger of engine damage.</p> <ul style="list-style-type: none"> ► Stop the vehicle as soon as possible, paying attention to road and traffic conditions. ► Check the oil level with the oil dipstick (▷ page 221). ► If the engine oil level is correct: have the malfunction rectified immediately at a qualified specialist workshop. ► If the engine oil level is too low: have the vehicle towed to a qualified specialist workshop.
 <p>Oil sensor Visit workshop</p>	<p>There is a malfunction in the engine oil level display.</p> <ul style="list-style-type: none"> ► Have the vehicle checked immediately at a qualified specialist workshop.



Driving systems

Display messages	Possible causes/consequences and ► Solutions
<p>--- Cruise control</p>	<p>The activation conditions for cruise control have not been met. You can only activate cruise control from speeds of 20 mph (30 km/h).</p>
<p>Cruise control Visit workshop</p>	<p>Cruise control has been deactivated due to a malfunction.</p> <ul style="list-style-type: none"> ► Have cruise control checked at a qualified specialist workshop.
<p>Lane Keep. Assist Temporarily Unavailable</p>	<p>and the  indicator lamp lights up yellow. Lane Keeping Assist is deactivated and temporarily inoperative. Possible causes are:</p> <ul style="list-style-type: none"> • There are no lane markings present. • The camera's functionality is impaired due to heavy rain, snow or fog. • The camera cannot recognize the road markings: <ul style="list-style-type: none"> - It is too dark. - The lane markings are worn or are covered, for example, by dirt or snow. • The windshield is dirty in the camera's field of vision. <p>► Stop the vehicle paying attention to road and traffic conditions. ► Secure the vehicle to prevent it from rolling away (▷ page 130). ► Clean the windshield (▷ page 235), particularly in the camera's field of vision. If the  indicator lamp goes out, Lane Keeping Assist is operational again.</p>
<p>Lane Keep. Assist Inoperative</p>	<p>Lane Keeping Assist is faulty.</p> <ul style="list-style-type: none"> ► Have Lane Keeping Assist checked at a qualified specialist workshop.





Display messages	Possible causes/consequences and ► Solutions
Blind Spot Assist Inoperative	Blind Spot Assist is faulty. ► Have Blind Spot Assist checked at a qualified specialist workshop.
Collision Prevention Assist Inoperative	COLLISION PREVENTION ASSIST is faulty. ► Have COLLISION PREVENTION ASSIST checked at a qualified specialist workshop. Recognition by the radar sensor system can be impaired in the case of: <ul style="list-style-type: none"> • dirt on the sensors or anything else covering the sensors • snow or heavy rain • interference from other radar sources • there are strong radar reflections, for example in parking garages • a narrow vehicle traveling in front, e.g. a motorbike • a vehicle traveling in front on a different line ► Clean the radar sensor system area.
Intervention Crosswind Assist	The  indicator lamp also flashes in the instrument cluster. Crosswind Assist has intervened perceptibly.



Tires

Display messages	Possible causes/consequences and ► Solutions
Tire pres. Adjust pres. 	The pressure is insufficient in one or more tires, or the pressures of the individual tires differ significantly. ► Check the tire pressure at the next opportunity and correct it if necessary (> page 253).
Tire pres. monitor inoperative	The tire pressure monitor has malfunctioned. ► Have the tire pressure monitor and the wheels checked at a qualified specialist workshop.
Tire pres. monitor currently unavailable	The tire pressure monitor function is temporarily unavailable due to radio interference or undervoltage. ► Once the causes have been remedied, the tire pressure monitor is automatically activated.
Tire pres.-monitor inoperative No wheel sensors	The tire pressure monitor is not receiving signals from one or more wheels because: <ul style="list-style-type: none"> • a wheel has been replaced with the spare wheel without wheel electronics. • the maximum temperature on one of the wheel electronics units has been exceeded. • the wheel electronics are malfunctioning. ► Have the tire pressure monitor and the wheels checked at a qualified specialist workshop.

Display messages	Possible causes/consequences and ► Solutions
<p>Check tire(s)</p> 	<p>The pressure of one or more tires has dropped significantly. If the tire pressure monitor has detected the affected wheel, the wheel position is also displayed.</p> <ul style="list-style-type: none"> ► Stop the vehicle as soon as possible, paying attention to road and traffic conditions. ► Check the tires. ► Repair or change the wheel if necessary (▷ page 266). ► Check the tire pressure and correct it if necessary (▷ page 253). The display message disappears automatically after driving for a few minutes with the corrected tire pressure.
<p>Warning Tire defect</p> 	<p>One or more tires is losing air rapidly. If the tire pressure monitor has detected the affected wheel, the wheel position is also displayed.</p> <ul style="list-style-type: none"> ► Stop the vehicle without making any sudden steering or braking maneuvers, paying attention to the traffic conditions as you do so. ► Repair or change the wheel (▷ page 266).

Vehicle

Display messages	Possible causes/consequences and ► Solutions
 <p>Steering Assistance Failure</p>	<p>The power assistance for the steering has malfunctioned. You need to steer more forcefully.</p> <ul style="list-style-type: none"> ► Carefully continue to a qualified specialist workshop and have the steering checked immediately.
 <p>Battery/Alternator Visit workshop</p>	<p>The battery is not being charged. Possible causes are a defective alternator or a torn poly-V-belt.</p> <ul style="list-style-type: none"> ► Stop the vehicle as soon as possible, paying attention to road and traffic conditions. ► Check the poly-V-belt. ► If the poly-V-belt is torn: do not continue driving. Consult a qualified specialist workshop. ► If the poly-V-belt is not damaged: have the vehicle checked as soon as possible by a qualified specialist workshop.
 <p>Electrically operated step</p>	<p>The electrical step has retracted or extended only partially or not at all.</p> <ul style="list-style-type: none"> ► Make sure there is sufficient free space for the electrical step. ► Open or close the sliding door again. ► If the electrical step still does not extend or retract fully, push the step in manually (▷ page 67). Before stepping out, remind the passengers that the step is missing.
 <p>Hood open</p>	<p>You are already driving at walking pace, even though the hood is not closed.</p> <ul style="list-style-type: none"> ► Close the hood.



Display messages	Possible causes/consequences and ► Solutions
 Please enter PIN:	You have not yet entered your PIN in the mobile phone. ► Enter the PIN for the SIM card.
 Doors open	You are already driving at walking pace, even though not all the doors are closed. ► Close the doors.
 Washer fluid Check level	The washer fluid level is too low. ► Add washer fluid (> page 224).









Key







Display messages	Possible causes/consequences and ► Solutions
 Replace key Visit workshop	The key is no longer working. ► Visit a qualified specialist workshop.







Indicator and warning lamps in the instrument cluster





When switching on the ignition, some systems carry out a self-test. Some indicator and warning lamps may temporarily turn on or start to flash. This is not an indication of any problem. Only when these indicator and warning lights turn on or start flashing after the engine has started or during the journey has a malfunction occurred.







Problem	Possible causes/consequences and ► Solutions
 The red distance warning lamp lights up while the vehicle is in motion.	The distance to the vehicle in front is too small for the speed selected. Increase the distance.
 The red distance warning lamp flashes while the vehicle is in motion. Additionally, an intermittent warning tone sounds.	You are approaching a vehicle ahead at too high a speed. ► Be prepared to brake immediately. ► Pay particular attention to the traffic situation. You may have to brake or take evasive action.
 The yellow Lane Keeping Assist indicator lamp lights up while you are driving.	Lane Keeping Assist is deactivated. ► Activate Lane Keeping Assist if necessary (> page 147).





Problem	Possible causes/consequences and ► Solutions
 The green Lane Keeping Assist indicator lamp lights up while you are driving.	Lane Keeping Assist is operational.
 The red Lane Keeping Assist indicator lamp lights up while you are driving. Additionally, an intermittent warning tone sounds.	You are driving with the front wheel on a lane marking.
 The yellow ASR/ESP® warning lamp flashes while the vehicle is in motion.	<p> WARNING</p> <p>ESP® or ASR is intervening because at least one of the wheels has reached its tire grip limit. Cruise control is deactivated for the duration of the intervention.</p> <ul style="list-style-type: none"> ► Adapt your driving style to suit the road and traffic conditions. Do not use too much throttle. ► Drive slowly.
 The yellow ASR/ESP® warning lamp is lit while the engine is running.	<p>The all-wheel drive is activated/deactivated. When changing gear, ASR and ESP® are deactivated. After changing gear, ASR and ESP® are automatically reactivated. Engage/disengage the all-wheel drive (▷ page 148).</p>
 The yellow ASR/ESP® warning lamp flashes slowly while the vehicle is in motion.	<p>In vehicles with all-wheel drive the brake system is overheated.</p> <p> WARNING</p> <p>The performance of 4ETS is reduced. The braking power output may be lower. There is a risk of an accident.</p> <ul style="list-style-type: none"> ► Drive on carefully and adapt your driving style to suit the road and traffic conditions. ► When the message is no longer displayed, 4ETS and normal braking power are available again.
 The yellow ASR/ESP® warning lamp is lit while the engine is running.	<p>ASR is deactivated.</p> <p> WARNING</p> <p>The driven wheels can spin when accelerating. There is an increased risk of skidding and accidents.</p> <ul style="list-style-type: none"> ► Activate ASR again. Exceptions (▷ page 53).





Problem	Possible causes/consequences and ► Solutions
 <p>The yellow ESP[®], ABS and ASR/BAS indicator lamps and the red brake system indicator lamp are lit while the engine is running.</p>	<p>EBD is malfunctioning or deactivated due to undervoltage or malfunction.</p> <p>The battery may not be being charged.</p> <p> WARNING</p> <p>The rear wheels could lock sooner than expected when you apply the brakes. The braking distance can increase in emergency braking situations.</p> <p>There is an increased risk of skidding and accidents.</p> <ul style="list-style-type: none"> ► Vehicles with steering wheel buttons: also observe the messages in the display (► page 176). ► Stop the vehicle as soon as possible, paying attention to road and traffic conditions. ► Do not drive on. ► Consult a qualified specialist workshop.
 <p>The red brake system indicator lamp is lit while the engine is running.</p>	<p>There is insufficient brake fluid in the expansion tank.</p> <p> WARNING</p> <p>Braking performance can be impaired.</p> <p>There is a risk of an accident.</p> <ul style="list-style-type: none"> ► Vehicles with steering wheel buttons: also observe the messages in the display (► page 176). ► Stop the vehicle as soon as possible, paying attention to road and traffic conditions. ► Check the brake fluid level in the expansion tank (► page 223). ► If the brake fluid is below the MIN mark: do not drive on! ► Do not add brake fluid. This does not solve the problem. ► Consult a qualified specialist workshop.
 <p>When towing a trailer: the red brake system indicator lamp is lit while the engine is running. Additionally, a warning tone sounds.</p>	<p> WARNING</p> <p>The brake force booster in the trailer is faulty.</p> <p>The driving and braking characteristics of your vehicle could change. There is a risk of the trailer overbraking and of you losing control over the truck/trailer combination.</p> <p>There is a risk of an accident.</p> <ul style="list-style-type: none"> ► Vehicles with steering wheel buttons: also observe the messages in the display (► page 176). ► Stop the vehicle as soon as possible, paying attention to road and traffic conditions. ► Do not drive on. ► Consult a qualified specialist workshop.





Problem	Possible causes/consequences and ► Solutions
 The yellow ASR/BAS indicator lamp is lit while the engine is running.	<p>ASR has been deactivated due to a malfunction. The engine power output may be reduced.</p> <p> WARNING</p> <p>The driven wheels can spin when accelerating. There is an increased risk of skidding and accidents.</p> <ul style="list-style-type: none"> ► Drive on with care. ► Consult a qualified specialist workshop as soon as possible.
 The yellow ASR/BAS indicator lamp is lit while the engine is running.	<p>BAS has been deactivated due to a malfunction.</p> <p> WARNING</p> <p>The brake system continues to function normally, but without electronic support. The braking distance can increase in emergency braking situations. There is a risk of an accident.</p> <ul style="list-style-type: none"> ► Drive on with care. ► Visit a qualified specialist workshop immediately.
 The yellow ASR/BAS indicator lamp is lit while the engine is running.	<p>ASR and BAS have been deactivated due to undervoltage. The battery may not be being charged.</p> <p> WARNING</p> <p>The brake system is still available with the normal braking effect. The driven wheels can spin when accelerating. The braking distance can increase in emergency braking situations. There is an increased risk of skidding and accidents.</p> <ul style="list-style-type: none"> ► Drive on with care. ► Visit a qualified specialist workshop immediately.







Problem	Possible causes/consequences and ► Solutions
 The yellow ABS indicator lamp is lit while the engine is running.	<p>ABS is deactivated due to a malfunction or is temporarily unavailable. ESP[®], ASR and BAS, as well as cruise control, are also unavailable as a result.</p> <p>Self-diagnosis may not be complete, or the battery may not be charging.</p> <p> WARNING</p> <p>The brake system continues to function normally, but without the functions listed above. The wheels could therefore lock, e.g. if the brakes are applied with maximum force.</p> <p>This causes steerability and braking to be greatly impaired.</p> <p>The braking distance can increase in emergency braking situations.</p> <p>The driven wheels can spin when accelerating.</p> <p>If ESP[®] is not operational, ESP[®] will not stabilize the vehicle.</p> <p>There is an increased risk of skidding and accidents.</p> <p>► Drive a short distance at a speed above 13 mph (20 km/h). The functions mentioned above are available again when the indicator lamp goes out.</p> <p>If the indicator lamp does not go out:</p> <p>► Drive on with care.</p> <p>► Visit a qualified specialist workshop immediately.</p>
 The yellow DEF indicator lamp is lit while the engine is running.	<p>The exhaust gas aftertreatment is malfunctioning or the current Diesel Exhaust Fluid (DEF) supply is limiting the vehicle range.</p> <p>► Observe the messages in the display.</p>
 The yellow ESP [®] indicator lamp is lit while the engine is running.	<p>ESP[®] is deactivated due to undervoltage or a malfunction. As a result, cruise control has also been deactivated.</p> <p>Engine power output may be reduced.</p> <p>The battery may not be being charged.</p> <p> WARNING</p> <p>If ESP[®] is not operational, ESP[®] will not stabilize the vehicle.</p> <p>There is an increased risk of skidding and accidents.</p> <p>► Vehicles with steering wheel buttons: also observe the messages in the display (► page 176).</p> <p>► Drive on with care.</p> <p>► Visit a qualified specialist workshop immediately.</p>





Problem	Possible causes/consequences and ► Solutions
 The red warning lamp does not go out approximately 4 seconds after the ignition is switched on, or it lights up again.	<p>The restraint systems have malfunctioned.</p> <p> WARNING</p> <p>If the restraint systems are malfunctioning, individual systems could be triggered inadvertently or might not be triggered at all in the event of an accident.</p> <p>There is an increased risk of injury and accidents.</p> <ul style="list-style-type: none"> ► Drive on with care. ► Visit a qualified specialist workshop immediately.
 The red battery indicator lamp is lit while the engine is running.	<p>The battery is not being charged. Possible causes are a defective alternator or a torn poly-V-belt.</p> <ul style="list-style-type: none"> ► Stop the vehicle as soon as possible, paying attention to road and traffic conditions. ► Check the poly-V-belt. ► If the poly-V-belt is torn: do not continue driving. Consult the nearest qualified specialist workshop. ► If the poly-V-belt is not damaged: have the vehicle checked as soon as possible by a qualified specialist workshop.
 The red battery indicator lamp is lit while the engine is running.	<p>The battery is faulty.</p> <ul style="list-style-type: none"> ► Stop the vehicle as soon as possible, paying attention to road and traffic conditions. ► Do not continue driving under any circumstances. ► Consult a qualified specialist workshop.
 The yellow brake pad wear indicator lamp is lit after the engine is started or while the vehicle is in motion.	<p>The brake pads/linings have reached their wear limit.</p> <p> WARNING</p> <p>Braking performance can be impaired.</p> <p>There is a risk of an accident.</p> <ul style="list-style-type: none"> ► Have the brake pads/linings replaced as soon as possible at a qualified specialist workshop.
 The yellow engine oil level warning lamp is lit after the engine is started or while the vehicle is in motion.	<p>The oil level has dropped to the minimum level.</p> <ul style="list-style-type: none"> ► Check the engine for oil loss. ► If oil loss is detected: consult a qualified specialist workshop immediately. ► If no oil loss is detected: check the oil level and add engine oil (► page 221).

Problem	Possible causes/consequences and ► Solutions
 <p>The yellow engine oil level warning lamp flashes and the warning buzzer sounds after the engine is started or while the vehicle is in motion.</p>	<p>On vehicles with a diesel engine, the oil level display additionally appears in the display, e.g. - 2.0 qts (Canada: - 2.0 ltr). There is not enough or no oil in the engine. There is a danger of engine damage.</p> <ul style="list-style-type: none"> ► Stop the vehicle as soon as possible, paying attention to road and traffic conditions. ► Check the oil level with the oil dipstick (► page 221). ► If the engine oil level is correct: have the malfunction rectified immediately at a qualified specialist workshop. ► If the engine oil level is too low: have the vehicle towed to a qualified specialist workshop.
 <p>The yellow engine oil level warning lamp lights up and the warning buzzer sounds after the engine is started or while the vehicle is in motion.</p>	<p>The engine oil level is above the maximum level. There is a risk of damaging the engine or catalytic converter.</p> <ul style="list-style-type: none"> ► Check the oil level with the oil dipstick (► page 221). ► If the oil level is too high: have the engine oil extracted as soon as possible at a qualified specialist workshop. ► If the oil level is correct: have the malfunction rectified as soon as possible at a qualified specialist workshop.
 <p>On vehicles with a diesel engine, the yellow engine oil level warning lamp lights up repeatedly during the journey.</p>	<p>There is a malfunction in the engine oil level display.</p> <ul style="list-style-type: none"> ► Have the vehicle checked immediately at a qualified specialist workshop.
 <p>The yellow coolant level warning lamp lights up while the engine is running.</p>	<p>The coolant level is too low. Never run the engine if the coolant level is too low. The engine could overheat and be damaged.</p> <ul style="list-style-type: none"> ► Stop the vehicle as soon as possible, paying attention to road and traffic conditions. ► Switch off the engine and let it cool down. ► Add coolant and be sure to observe the warning notes (► page 222). ► If you need to add coolant frequently, have the engine cooling system checked at a qualified specialist workshop.
 <p>The red coolant warning lamp is lit while the engine is running.</p>	<p>The coolant temperature is too high.</p> <ul style="list-style-type: none"> ► Stop the vehicle as soon as possible, paying attention to road and traffic conditions. ► Consult a qualified specialist workshop.

Problem	Possible causes/consequences and ► Solutions
 The red coolant warning lamp is lit while the engine is running.	<p>The coolant temperature is too high.</p> <p>If the vehicle is stopped after being subjected to extreme loads, the coolant warning lamp may come on when the ignition is switched on or the engine is restarted. Such loads can be, for example, driving in mountainous terrain or driving with a trailer.</p> <ul style="list-style-type: none"> ► Run the engine for approximately 1 minute at idling speed. ► Consult a qualified specialist workshop if the display message continues to be shown.
 The yellow reserve fuel warning lamp is on. At the same time, 0 appears in the fuel tank content display while the engine is running, although there is fuel in the fuel tank.	<p>The fuel filler cap is not closed.</p> <ul style="list-style-type: none"> ► Close the fuel filler cap. You will hear a click when the fuel filler cap is closed fully. ► If the malfunction continues to be displayed, have it rectified immediately at a qualified specialist workshop.
 The yellow Check Engine indicator lamp is lit up or flashes while the engine is running.	<p>You have used up all fuel in the tank. The engine is running in emergency mode.</p> <ul style="list-style-type: none"> ► Refuel at the nearest gas station (▷ page 127). ► Bleed the fuel system (▷ page 123). ► Start the engine three to four times in succession after refueling. Emergency running mode will be canceled. The vehicle does not need to be checked.
 The yellow Check Engine indicator lamp is lit up or flashes while the engine is running.	<p>The injection control is malfunctioning. The engine is running in emergency mode. Engine power output may be reduced.</p> <ul style="list-style-type: none"> ► Have the vehicle checked at a qualified specialist workshop as soon as possible. <p>In some states it is legally prescribed that after the check engine indicator lamp lights up you must contact a qualified specialist workshop immediately. Observe the legal requirements.</p>

Problem	Possible causes/consequences and ► Solutions
 The yellow Check Engine indicator lamp is lit while the engine is running.	<p>The exhaust gas aftertreatment is malfunctioning or an emission relevant malfunction has occurred. This malfunction or defect can damage the exhaust gas aftertreatment.</p> <p>After the first message and under normal operating conditions, you can drive on for up to approximately 500 mi (800 km). Then a warning tone sequence sounds and the engine can only be started another 16 times.</p> <ul style="list-style-type: none"> ► Observe the messages in the display. ► Have the exhaust gas aftertreatment checked immediately at a qualified specialist workshop. <p>In some states it is legally prescribed that after the check engine indicator lamp lights up you must contact a qualified specialist workshop immediately. Observe the legal requirements.</p>
 If you turn the key to position 2 in the ignition lock, the yellow preglow indicator lamp remains lit for approximately 1 minute. Or the yellow preglow indicator lamp lights up for approximately 1 minute while the engine is running.	<p>At extremely low temperatures, the engine may not start. There is a malfunction in the preglow system.</p> <ul style="list-style-type: none"> ► Have any malfunction rectified at a qualified specialist workshop.
 The yellow diesel particle filter indicator lamp is lit while the engine is running.	<p>The automatic regeneration of the diesel particle filter is not sufficient or has malfunctioned.</p> <ul style="list-style-type: none"> ► Drive at an engine speed above 2000 rpm until the diesel particle filter indicator lamp goes out. ► If the diesel particle filter indicator lamp does not go out after approximately 20 minutes: have the malfunction rectified immediately at a qualified specialist workshop.
 The yellow air filter indicator lamp is lit while the engine is running.	<p>The service limit for the air filter has been reached. The air filter is dirty.</p> <ul style="list-style-type: none"> ► Have the air filter element replaced as soon as possible at a qualified specialist workshop.

Problem	Possible causes/consequences and ► Solutions
 The yellow tire pressure monitor warning lamp comes on.	 WARNING The tire pressure monitor indicates a rapid or severe loss of pressure in at least one tire. <ul style="list-style-type: none"> ► Stop the vehicle without making any extreme steering maneuvers or braking suddenly. Pay attention to the traffic conditions while doing so. ► Check the tires and correct the tire pressure. If a tire continues to lose pressure, it must be replaced. Replace damaged tires immediately. The warning light will go out after the flat tire has been rectified and you have been driving for a few minutes. ► Vehicles with steering wheel buttons: also observe the messages in the display (► page 176).
 US vehicles only: The yellow tire pressure monitor warning lamp flashes for 60 seconds and then remains lit.	The tire pressure monitor has malfunctioned. <ul style="list-style-type: none"> ► Have the tire pressure monitor and the wheels checked at a qualified specialist workshop.
 The yellow water separator indicator lamp is lit when the ignition is switched on.	The water that has collected in the water separator of the fuel filter has reached the maximum level. <ul style="list-style-type: none"> ► Drain the water separator (► page 224).
 The yellow water separator indicator lamp is lit when the ignition is switched on.	The fuel filter is dirty. <ul style="list-style-type: none"> ► Have the fuel filter element replaced as soon as possible at a qualified specialist workshop.
 The yellow washer fluid level indicator lamp for the windshield washer/headlamp cleaning system is lit after the engine is started or while the vehicle is in motion.	The water level is too low. <ul style="list-style-type: none"> ► Add washer fluid (► page 224).

Problem	Possible causes/consequences and ► Solutions
 The red seat belt warning lamp lights up continuously or flashes. A warning tone may also sound.	The warning lamp is to remind you to fasten your seat belt. ► Fasten seat belt (▷ page 42).
 When the key is turned to position 2 in the ignition lock, the yellow bulb warning lamp lights up.	One of the exterior lighting bulbs is faulty, with the exception of the perimeter lamps and the trailer lighting. i Depending on the equipment, the bulb failure indicator can fail for all lamps with the exception of the turn signal lamps. ► Replace the faulty bulb as soon as possible (▷ page 86).
 The yellow "door open" indicator lamp is lit while driving.	The vehicle is moving without all doors or the hood being closed. ► Close the doors or hood.
 The yellow "door open" indicator lamp is lit.	The electrical step has retracted or extended only partially or not at all. ► Make sure there is sufficient free space for the electrical step. ► Open or close the sliding door again. ► If the electrical step still does not extend or retract fully, push the step in manually (▷ page 67). Before stepping out, remind the passengers that the step is missing.
 The indicator lamp for the steering is lit when the ignition is switched on.	The power assistance for the steering has malfunctioned. You need to steer more forcefully. ► Carefully continue to a qualified specialist workshop and have the steering checked immediately.

Useful information

This Operator's Manual describes all models as well as standard and optional equipment of your vehicle that were available at the time of going to print. Country-specific variations are possible. Note that your vehicle may not be equipped with all of the described functions. This also applies to systems and functions relevant to safety.

Read the information on qualified specialist workshops (▷ page 26).

Stowage spaces and stowage compartments

Important safety notes

WARNING

If you do not correctly store objects in the vehicle interior, they can slip or be flung around, thus striking vehicle occupants. There is a risk of injury, especially when braking or abruptly changing directions.

- Always store objects so that they cannot be flung around in these or in similar situations.
- Always make sure that objects do not protrude from stowage compartments, parcel nets or stowage nets.
- Close lockable stowage compartments while driving.
- Stow and secure objects that are heavy, hard, pointy, sharp-edged, fragile or too large in the trunk.

In addition, observe the information in the "Loading guidelines" section (▷ page 212).

Glove box

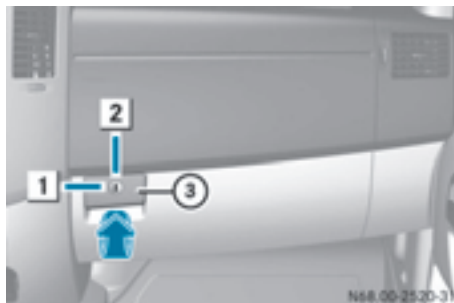

Glove box (example: glove box with a lockable lid)

- 1 Unlocked
- 2 Locked
- 3 Glove box handle

You can lock and unlock the glove box using the mechanical or folding key.

- ▶ **To open:** unlock the glove box lid if necessary.
- ▶ Pull glove box handle 3 in the direction of the arrow.

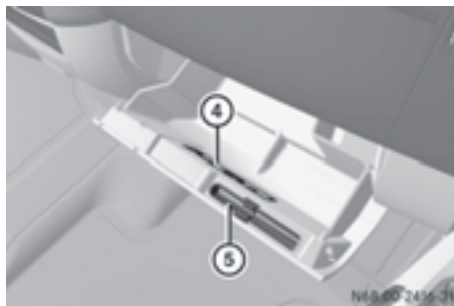

- 4 Card holder
- 5 Pen holder

- ▶ **To close:** fold the glove box up and press it until it engages.

Eyeglasses compartment in the overhead control panel



- ▶ **To open:** briefly press cover ①.
The eyeglasses compartment opens downwards.
- ▶ **To close:** press the eyeglasses compartment into the overhead control panel until it engages.

Make sure that the eyeglasses compartment is always closed while the vehicle is in motion.

Dashboard stowage compartments

WARNING

Objects protruding from the stowage compartment above the front passenger front air bag could obstruct or even prevent deployment of the front passenger front air bag. The front passenger front air bag may then fail to provide the intended protection. There is an increased risk of injury.

Do not place any protruding objects in the stowage compartment above the front passenger front air bag.

- ❗ The right and left storage spaces may be loaded with a maximum of 11 lb (5 kg) each.



Stowage space (example: front passenger side)



Stowage compartment equipped with smartphone connections

- ③ USB port
- ④ 3.5 mm audio jack
- ❗ Depending on the vehicle equipment, a USB port and an AUX-in connection is installed in the stowage compartment. A Media Interface is a universal interface for portable audio equipment, e.g. for an iPod® or MP3 player (see the separate audio system operating instructions).

Stowage compartment in the center console



Stowage compartment on the dashboard above the center console (example with lid)

The stowage compartments on and in the center console can be used to store small, light objects.

- ▶ **To open:** pull release handle ②.
- Lid ① swings up.
- ▶ **To close:** close lid ① and engage it.

The lid of the stowage compartment must remain closed while the vehicle is in motion to ensure that stowed objects are contained safely.

Stowage space above the headliner

❗ The entire stowage space may be loaded with a maximum of 66 lb (30 kg).

Do not place high, bulky loads in the stowage space. You could otherwise damage the headliner in the event of sharp braking.



On vehicles with a partition, stowage space ① can only be loaded from the cargo compartment.

Stowage space above the windshield

❗ The right and left stowage spaces may be loaded with a maximum of 5.5 lb (2.5 kg) each.



Stowage compartment (example: driver's side)

① Stowage compartment

Stowage compartment under the twin front-passenger seat



Twin front-passenger seat (example: Cargo Van)

You can stow various articles in the stowage compartment under the twin front-passenger seat.

- ▶ **To fold a seat cushion forwards:** lift the seat cushion out of front anchorage ①.
- ▶ Pull the seat cushion forwards slightly and out of rear anchorage ②.
- ▶ Fold the rear edge of the seat cushion up.
- ▶ **To fold the seat cushion back:** fold down the seat cushion by the rear edge.
- ▶ Slide the seat cushion under the seat backrest into rear anchorage ②.
- ▶ Push down on the seat cushion at the front until it engages in front anchorage ①.

Stowage compartment under the rear bench seat

WARNING

Always secure the folded-up seat cushion with the retainer loop. The seat cushion could otherwise drop down unexpectedly and thereby cause injury to yourself or others.

WARNING

When folding down the seat cushion, make sure that nobody can become trapped.

! The retainer loop is neither a grab handle for people to use nor a securing point for loads. It may tear if used incorrectly.



For vehicles with a crewcab, you can use the stowage compartment under the rear bench seat to safely store tools and other small items.

► **To fold up the rear bench seat:** lift seat cushion ① out of the front anchorage and fold it upwards in the direction of the arrow.

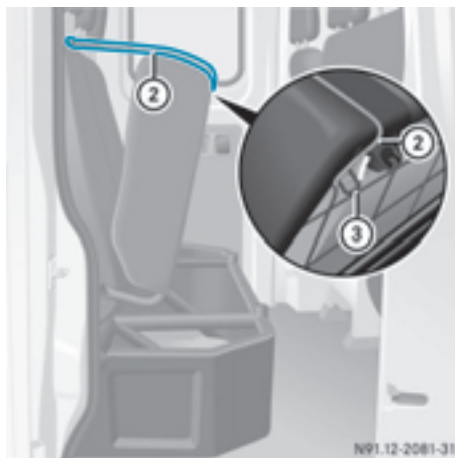

Retainer loops ② are secured to the outer head restraints.

- Attach retainer loop ② to hook ③ underneath folded-up seat cushion ①.
- **To fold down the seat cushion:** hold seat cushion ① and detach retainer loop ② from hook ③.
- Fold down seat cushion ①. The seat cushion engages automatically.

Paper holder



► **To open:** press the top of paper holder ①.

Cup holder

Important safety notes

WARNING

The cup holder cannot hold a container secure whilst traveling. If you use a cup holder whilst traveling, the container may be flung around and liquid may be spilled. The vehicle occupants may come into contact with the liquid and if it is hot, they may be scalded. You may be distracted from the traffic conditions and you could lose control of the vehicle. There is a risk of an accident and injury.

Only use the cup holder when the vehicle is stationary. Only use the cup holder for containers of the right size. Always close the container, particularly if the liquid is hot.

! Do not use the cup holder recesses as ashtrays. This could damage the cup holders.

Cup holders in the dashboard

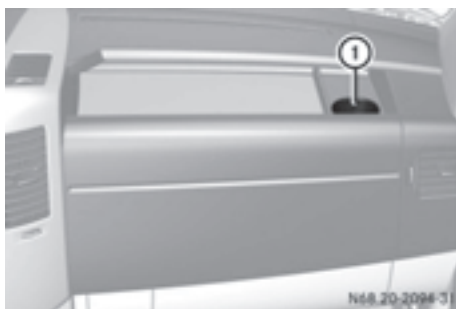

Cup holder in dashboard stowage compartment (example: right-hand side of vehicle)

① Cup holder

Cup holders in the center console

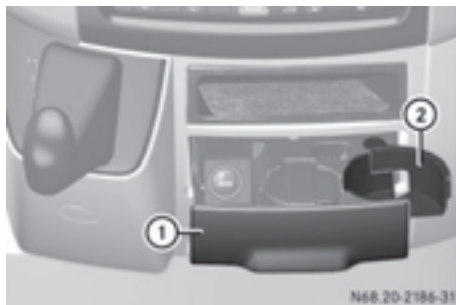

Cup holders in the center console

- ▶ **To open:** pull out ashtray compartment ① by the recess.
Clamping arm ② of the cup holder opens out fully.
- i** Vehicles with the non-smoking package have an additional cup holder instead of the ashtray.
- ▶ Place the beverage container into the cup holder and push clamping arm ② against the container.
- ▶ **To close:** push ashtray compartment ① into the center console until it engages.

Bottle holder



Bottle holders ① in the front doors (example: co-driver's door)

Ashtray

Ashtray in the center console

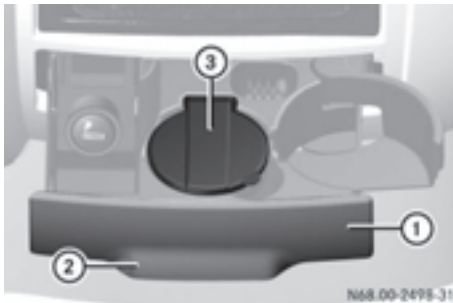

Ashtray in the center console

- ▶ Pull ashtray compartment ① out by recess ②.
- ▶ **To open:** fold cover ③ upwards.
- ▶ **To remove the insert:** hold the ashtray by the recesses on the left and right and pull the insert out to empty it.
- ▶ **To replace the insert:** press it down into the holder as shown. Make sure that the insert is inserted correctly. Otherwise you will not be able to close ashtray compartment ①.

Ashtrays in the passenger compartment



Ashtrays on the left and right in the side trim panels

- ▶ **To open:** fold out the ashtray.
- ▶ **To remove the insert:** press retaining clip ① down and remove the ashtray from the trim.
- ▶ **To replace the insert:** insert the ashtray down into the trim and close it.

Cigarette lighter

⚠ WARNING

You can burn yourself if you touch the hot heating element or the socket of the cigarette lighter.

In addition, flammable materials can ignite if:

- the hot cigarette lighter falls
- a child holds the hot cigarette lighter to objects, for example

There is a risk of fire and injury.

Always hold the cigarette lighter by the knob. Always make sure that the cigarette lighter is out of reach of children. Never leave children unsupervised in the vehicle.

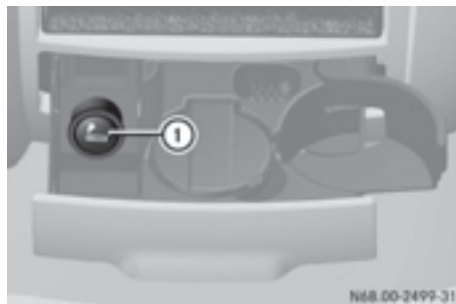

- ▶ **To use the cigarette lighter:** turn the key to position 1 in the ignition lock.
- ▶ Press in cigarette lighter ①. The cigarette lighter will pop out automatically when the heating element is red-hot.
- ▶ Pull the cigarette lighter out of the socket by its handle.

12 V socket



Socket on the lower section of the center console

① 12 V socket (25 A)

The 12 V sockets for accessories are:

- on the lower section of the center console (12 V, 25 A)
- on the inside of the driver's seat frame (12 V, 15 A)
- in the respective corner trim next to the rear doors in the passenger compartment (12 V, 15 A)
- in the cargo compartment next to the left rear door (12 V, 15 A)

You can use the 12 V sockets (15 A) for accessories with a maximum power consumption of 180 W. You can connect accessories with a maximum power consumption of 300 W to the 12 V socket (25 A) on the lower section of the center console.

- ⓘ The sockets are supplied with power even when the key is removed from the ignition lock. If accessories, e.g. a coolbox, remain connected while the engine is not running, the battery will discharge.

Mobile phone

Important safety notes

WARNING

If you operate information systems and communication equipment integrated in the vehicle while driving, you will be distracted from traffic conditions. You could also lose control of the vehicle. There is a risk of an accident.

Only operate the equipment when the traffic situation permits. If you are not sure that this is possible, park the vehicle paying attention to traffic conditions and operate the equipment when the vehicle is stationary.

You must observe the legal requirements for the country in which you are currently driving when operating mobile phones.

Bear in mind that at a speed of just 30 mph (approximately 50 km/h), your vehicle is covering a distance of 44 feet (approximately 14 m) every second.

You and others can suffer health-related damage through electromagnetic radiation. By using an exterior antenna, a possible health risk caused by electromagnetic fields, as discussed in scientific circles, is taken into account. Only have the exterior antenna installed by a qualified specialist workshop.

We recommend the use of an approved exterior antenna for operating the mobile phone. Only in this way can optimal mobile phone reception quality in the vehicle be ensured and mutual interference between the vehicle electronics and mobile phones minimized.

Observe the legal requirements for each individual country.

Mobile phone pre-installation

The mobile phone pre-installation includes a hands-free system integrated into the vehicle. The microphone for the hands-free system is installed in the overhead control panel or in the overhead stowage compartment together with the front interior light.

In order to use the hands-free system, you will need a special bracket. The Sprinter accessories include brackets for various mobile phone models.

- ⓘ Mobile phone brackets which are available from various manufacturers on the open market are not compatible with the Sprinter telephone system. You can recognize suitable holders for your mobile phone by the imprinted star and the B6 spare part number on the back of the bracket.

Detailed instructions for use can be found in the operating instructions for the mobile phone

bracket and in the separate operating instructions for the mobile phone pre-installation.

- i** The mobile phone battery is charged depending on the condition of charge and the position of the key in the ignition lock. The mobile phone display indicates the charging process.

Additional communications equipment

Important safety notes

WARNING

If you operate mobile communication equipment while driving, you will be distracted from traffic conditions. You could also lose control of the vehicle. There is a risk of an accident.

Only operate this equipment when the vehicle is stationary.

You must observe the legal requirements for the country in which you are currently driving when operating mobile communication equipment.

Please remember, a navigation system does not supply information on the load-bearing capacity of bridges or the overhead clearance of underpasses. The driver remains responsible for safety at all times.

You and others can suffer health-related damage through electromagnetic radiation. By using an exterior antenna, a possible health risk caused by electromagnetic fields, as discussed in scientific circles, is taken into account. Only have the exterior antenna installed by a qualified specialist workshop.

You will find information on installing electrical or electronic equipment in the "Vehicle electronics" section (▷ page 275).

Installation for PND mobile navigation devices

You can secure a personal navigation device (Personal Navigation Device PND) using a commercially available adapter.



PND connector (on the side behind the instrument cluster)

- ③ USB port
- ④ 3.5 mm audio jack for the PND audio signal (voice announcements)

► **Connecting the PND:** connect the PND ports to the appropriate jacks in the vehicle.

- i** You can also use USB port ③ and 3.5 mm audio jack ④ for external audio sources.

The voice announcements are heard through the radio speakers when you start navigation. The audio source played until this point is then muted for the duration of the voice announcements.

- i** If you use audio devices or personal navigation devices which have been recommended by Mercedes-Benz, you can use all of the functions available, such as the mute function.

You can obtain further information from any authorized Mercedes-Benz Center.

Useful information

This Operator's Manual describes all models as well as standard and optional equipment of your vehicle that were available at the time of going to print. Country-specific variations are possible. Note that your vehicle may not be equipped with all of the described functions. This also applies to systems and functions relevant to safety.

Read the information on qualified specialist workshops (▷ page 26).

Loading guidelines

Important safety notes

WARNING

As a result of improperly placed or unevenly distributed loads, the center of gravity of the load being transported may be too high or too far back. This can significantly impair handling as well as steering and braking characteristics. There is a risk of an accident.

Always make sure that the center of gravity of the load is:

- between the axles and
- as low as possible, near the rear axle.

WARNING

When objects are unsecured or inadequately secured, they can slip, turn over or be thrown about, striking vehicle occupants. This also applies to:

- luggage or loads
- a rear bench seat which has been removed and is being transported in the vehicle in an exceptional case.

There is a risk of injury, particularly in the event of braking maneuvers or abrupt changes in direction.

Always stow objects in such a way that they cannot be tossed about. Before traveling, secure objects, luggage or loads to prevent them slipping or tipping over. If you remove a

rear bench seat, it is advisable to store it outside the vehicle.

WARNING

When the permissible wheel loads, axle loads and/or the maximum permissible gross vehicle weight are exceeded, driving safety is compromised. The handling as well as steering and braking characteristics may be significantly impaired. Overloaded tires may overheat, causing them to burst. There is a risk of an accident.

When transporting a load, always observe the permissible wheel loads, axle loads and the maximum permissible gross vehicle weight for the vehicle (including occupants).

WARNING

When you load the roof, the center of gravity of the vehicle rises and the driving characteristics change. If you exceed the maximum roof load, the driving characteristics, as well as steering and braking, will be greatly impaired. There is a risk of an accident.

Never exceed the maximum roof load and adjust your driving style.

 If you are using a roof carrier, observe the maximum roof load and maximum roof carrier load.

You will find information about the maximum roof load in the "Technical data" section (▷ page 286) and information about roof carriers in the "Carrier systems" section (▷ page 216).

- Do not stack luggage or loads higher than the backrests.
- Stow objects preferably in the cargo compartment.
- When transporting luggage, always use the cargo tie-down rings and a parcel net, if present.
- Use cargo tie-down rings and fasteners which are suitable for the weight and size of the load.

Always observe the operating instructions of the respective manufacturer when using suitable load securing aids or tie downs. In particular, the information on service life.

Load securing aids and tie downs may not be used, for example, if:

- identification marks are missing or illegible
- there are yarn breakages, damage to bearing seams or other signs of tearing
- there are signs of shearing, deformation, pinching or other damage
- there is damage to clamping or connecting elements

Such load securing aids and tie downs are worn; they should not be used and must be replaced. If you use load securing aids or tie downs which are worn, the load may not be sufficiently secured and could cause damage to property.

After an accident, the following must be checked at a specialist workshop:

- Cargo compartment floor
- Load surface
- Cargo tie-down rings
- Tie downs

Otherwise, the load may not be correctly secured the next time anything is stowed.

Even if you follow all loading guidelines, the load increases the risk of injury in the event of an accident. Observe the tips in the "Securing luggage/loads" (▷ page 214) and "Load distribution" (▷ page 214) sections.

Before loading

! The anti-slip mats cannot be used for securing goods and must be replaced when they show signs of:

- Permanent deformation and crushing
- Crack formation
- Cuts

► **Tire pressure:** check the tire pressure and correct if necessary (▷ page 250).

► **Cargo compartment floor:** clean the cargo compartment floor.

The cargo compartment floor must be free from oil and dust, dry and swept clean to prevent the load from slipping.

► Place non-slip mats (anti-slip mats) on the cargo compartment floor if necessary.

During loading

! On passenger van versions with maximum seating layout, the permissible rear axle load would be exceeded if the full payload were to be loaded in the cargo compartment.

► Observe the gross axle weight rating and permissible gross vehicle weight for your vehicle. Take into account that your vehicle's curb weight is increased if accessories or optional equipment are installed. The maximum payload is thus reduced.

► Observe the notes on load distribution (▷ page 214).

The overall center of gravity of the load should always be as low as possible, centered and between the axles near the rear axle.

► Secure the load (▷ page 214). Observe the legal requirements of the country in which you are currently driving.

Checks after loading

WARNING

Combustion engines emit poisonous exhaust gases, such as carbon monoxide. If the sliding door or rear door is open when the engine is running, exhaust gases can enter the vehicle interior, especially during the journey. There is a risk of poisoning.

Always switch off the engine before opening the sliding door or rear door. Never drive the vehicle when the sliding door or rear door is open.

► **Securing loads:** check that the load is secure before every journey and at regular intervals during a long journey, and correct if necessary.

► **Doors:** close the sliding doors and rear doors.

► **Tire pressure:** adjust the tire pressures according to the vehicle load (▷ page 250).

► **Driving style:** adapt your driving style according to the vehicle load.

Load distribution

General notes

! Excessive loads on individual points of the cargo floor or on the load surface impair vehicle handling characteristics and could cause damage to the floor covering.

The overall center of gravity of the load should always be as low as possible, centered and between the axles near the rear axle.

On Cargo Vans and Passenger Vans:

- ▶ Always transport loads in the cargo compartment.
- ▶ Always place the load against the backrests of the rear bench seat.
- ▶ Move large and heavy loads as far towards the front of the vehicle as possible against the rear bench seat. Stow the load flush with the rear bench seat.
- ▶ Always additionally secure the load with suitable load-securing aids or tie downs.

Observe the following notes:

- Do not stack loads higher than the upper edge of the backrests.
- Transport loads behind seats that are not occupied.
- If the rear bench seat is not occupied, insert the seat belts crosswise into the buckle of the opposite seat belt.

Securing loads

Important safety notes

WARNING

If you attach the tie-down incorrectly when securing the load, the following may occur in the event of abrupt changes in direction, braking maneuvers or an accident:

- the cargo tie-down rings may become detached or the tie-down may tear if the permissible load is exceeded
- the load may not be restrained.

This may cause the load to slip, tip over or be tossed about, striking vehicle occupants.

There is a risk of an accident and injury.

Always tension the tie-downs in the proper manner and only between the described cargo tie-down rings. Always use tie-downs designed specifically for the loads.

WARNING

You may not transport anyone in the cargo compartment or on the load surface. Never let more people ride in the vehicle than there are seat belts available. Make sure everyone riding in the vehicle is correctly restrained with a separate seat belt. Never use a seat belt for more than one person at a time.

! Observe the information on the maximum loading capacity of the individual cargo tie-down points.

If you use several cargo tie-down points to secure a load, you must always take the maximum loading capacity of the weakest cargo tie-down point into account.

If you brake hard, for example, the forces acting could be up to several times the weight force of the load. Always use multiple cargo tie-down points in order to distribute the force absorption. Load the anchorages evenly.

Spread the load evenly between the cargo tie-down points or tie-down rings.

Please also refer to the notes about qualified specialist workshops (▷ page 26).

Always observe the operating instructions or the notes of the lashing strap manufacturer for the operation of the lashing strap.

Information about the maximum loading capacity of the cargo tie-down points can be found in the "Technical data" section (▷ page 285).

As the driver, you are responsible for ensuring that:

- The load is secured against slipping, tipping, rolling or falling off. This applies both in normal traffic conditions and if the vehicle must swerve to avoid an obstacle, in the event of full brake application and on poor road surfaces.
- The applicable requirements and guidelines relating to load-securing practices must be met.

If this is not the case, this may constitute a punishable offense, depending on local legislation and any ensuing consequences.

You should therefore observe the respective legal requirements for the relevant country.

Make sure that the load is secure before every journey and at regular intervals during a long journey. Correct an incorrectly or inadequately secured load if necessary.

You can obtain information about securing the load correctly from the manufacturer of the load securing aids or tie down for securing the load.

- ▶ Fill spaces between the load and the cargo compartment walls or wheel housings (form-locking). Use rigid load securing aids, such as wedges, wooden fixings or padding.
- ▶ Attach secured and stabilized loads in all directions. Use the cargo tie-down points or cargo tie-down rings and the loading rails in the cargo compartment or on the cargo area. Only use tie downs, such as lashing rods or lashing nets and lashing straps, that have been tested in accordance with current standards (e.g. DIN EN).

Always use the cargo tie-down rings closest to the load to secure it and pad sharp edges for protection.

Loads, and heavy loads in particular, should preferably be secured using the cargo tie-down rings.

- i** Tie downs tested in accordance with current standards (e.g. DIN EN) are available at any qualified specialist workshop.

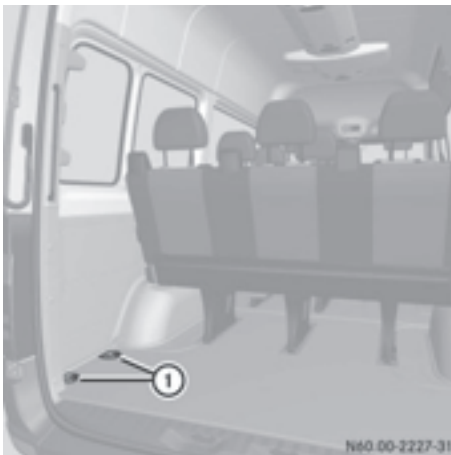

Cargo tie-down points (example: Passenger Van)

- ① Cargo tie-down rings

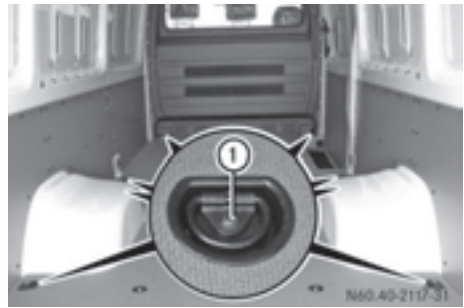

Cargo tie-down point (example: Cargo Van without loading rails)

- ① Cargo tie-down rings

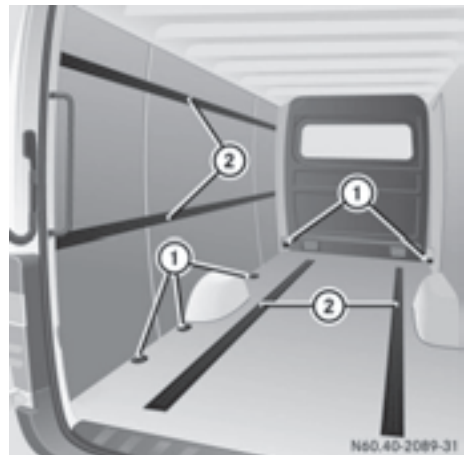

Cargo tie-down points (example: Cargo Van with loading rails)

- ① Cargo tie-down rings
- ② Load rails

Secure loose loads with a tested lashing net or a tarpaulin.

- ▶ Always fasten the lashing net or tarpaulin to all available cargo tie-down points. Make sure that the retaining hooks are secured against accidental opening.

If your vehicle is equipped with loading rails ② in the floor, you can place lashing rods directly in front of and behind the load. The lashing rods directly absorb the potential shifting forces.

Securing loads on the cargo compartment floor by lashing them down is only recommended for lightweight loads. Place non-slip mats (anti-slip mats) under the load to increase load security.

Installing/removing cargo tie-down rings for the load rails

WARNING

If the cargo tie-down ring is not properly installed, it may slip or become detached in the event of abrupt changes in direction, braking maneuvers or an accident. This may cause objects, luggage or the load to slip, tip over or be tossed about, striking vehicle occupants. There is a risk of injury.

Before using the cargo tie-down rings, always make sure they are properly installed and cannot be moved.

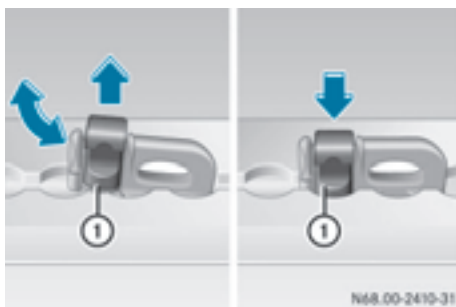

► **To install:** slide the cargo tie-down ring through a recess in the loading rail close to the load until locking mechanism ① engages in the recess.

i When you pull locking mechanism ① up and out of the recess, the cargo tie-down ring is able to move within the loading rail. Make sure that locking mechanism ① is always engaged in a recess.

► Check the cargo tie-down ring for firm seating.

► **To remove:** pull locking mechanism ① up and pull the cargo tie-down ring towards the locking mechanism and out of the loading rail through a recess.

Carrier systems

Roof carrier

WARNING

When you load the roof, the center of gravity of the vehicle rises and the driving characteristics change. If you exceed the maximum roof load, the driving characteristics, as well as steering and braking, will be greatly impaired. There is a risk of an accident.

Never exceed the maximum roof load and adjust your driving style.

You can find information about the maximum roof load in the "Technical data" section (> page 286).

! Make sure that:

- the screws for the roof carrier are tightened in the sliding blocks to a torque of 6.0 – 7.4 lb-ft (8 – 10 Nm)
- the bolts, when tightened, do not touch the rails.
- the slot nuts are not located in the area of the plastic caps.
- the slot nuts have the right cross-section.
- the mounting rails in the interior are free of dirt.
- the screws are retightened evenly after approximately 300 miles (500 km).

We recommend that you only use roof racks tested and approved by Sprinter. These help avoid vehicle damage.

! If you want to retrofit securing rails, have it done at a qualified specialist workshop. You could otherwise damage the vehicle.



① Securing rails

It is possible to install a roof carrier if your vehicle is equipped with securing rails on the roof. Special mounting elements (grooved plates) are available as accessories.

These mounting elements are available at any authorized Sprinter Dealer.

Ladder carrier



Example: ladder rack on Chassis Cab

- ① Front ladder rack
- ② Rear ladder rack

Pay attention to the important safety notes in the "Loading guidelines" section (▷ page 212).

You can find information about the maximum ladder rack load in the "Technical data" section (▷ page 216).

You will find information about cleaning and care in the "Notes on care" (▷ page 233) and "Power washers" (▷ page 234) sections.

Useful information

This Operator's Manual describes all models as well as standard and optional equipment of your vehicle that were available at the time of going to print. Country-specific variations are possible. Note that your vehicle may not be equipped with all of the described functions. This also applies to systems and functions relevant to safety.

Read the information on qualified specialist workshops (▷ page 26).

Engine compartment

Hood

Important safety notes

WARNING

If the hood is unlatched, it may open up when the vehicle is in motion and block your view. There is a risk of an accident.

Never unlatch the hood while driving.

WARNING

Opening the hood when the engine is overheated or when there is a fire in the engine compartment could expose you to hot gases or other service products. There is a risk of injury.

Let an overheated engine cool down before opening the hood. If there is a fire in the engine compartment, keep the hood closed and contact the fire department.

WARNING

The engine compartment contains moving components. Certain components, such as the radiator fan, may continue to run or start again suddenly when the ignition is off. There is a risk of injury.

If you need to do any work inside the engine compartment:

- switch off the ignition
- never reach into the area where there is a risk of danger from moving components, such as the fan rotation area
- remove jewelry and watches
- keep items of clothing and hair, for example, away from moving parts

WARNING

The fuel injection system operates with a high voltage. If you touch the live components, you could receive an electric shock. There is a risk of injury.

Never touch components of the fuel injection system when the ignition is switched on.

The live components of the fuel injection system are, for example, the injectors.

WARNING

Certain components in the engine compartment, such as the engine, radiator and parts of the exhaust system, can become very hot. Working in the engine compartment poses a risk of injury.

Where possible, let the engine cool down and touch only the components described in the following.

If you have to carry out work in the engine compartment, only touch the following components:

- Hood
- Oil dipstick
- Engine oil filler neck cap
- Washer fluid reservoir cap
- Coolant expansion tank cap

Opening the hood

-  Make sure that the windshield wipers are not folded away from the windshield. You could otherwise damage the windshield wipers or the hood.



Release handle for the hood

Observe the safety notes when you open the hood.

- ▶ Stop your vehicle as far away from traffic as possible on level ground.
- ▶ Switch off the engine.
- ▶ Secure the vehicle to prevent it from rolling away.
- ▶ Pull release handle ① on the hood. The hood is released.

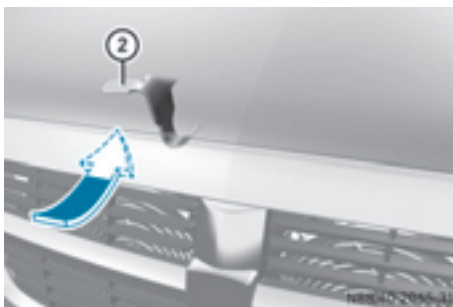

- ▶ Reach into the gap and push lever ② on the hood catch up.

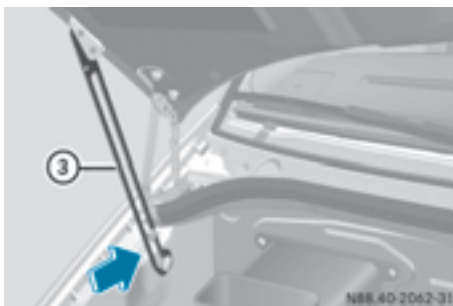

- ▶ Swing the hood upwards until support strut ③ engages and the hood is supported.

Closing the hood

WARNING

If the hood is unlatched, it could tip forward during rapid deceleration of the vehicle and hit persons or objects within its path. There is a risk of an accident and injury.

Therefore, always make sure that the hood is closed and locked completely before driving off.

If the hood is not locked and you are already driving at walking pace:

- the yellow indicator lamp in the instrument cluster goes on for vehicles without steering-wheel buttons.
- the **Hood open** display appears for vehicles with steering-wheel buttons.

! When you press the support strut back, make sure that you do not press it against the detent position and cause it to bend.

! Do not use your hands to push the hood down. You could damage it otherwise.

- ▶ Lift the hood slightly.
- ▶ Press support strut ③ towards the back.
- ▶ Lower the hood and allow it to fall with momentum from a height of approximately 1 ft (30 cm).

The hood locks audibly.

- ▶ Check that the hood is correctly locked. If the hood can be raised slightly, it is not properly engaged. If the hood is not correctly engaged, open the hood again. Let the hood fall with a little more momentum.

Overview of the engine compartment

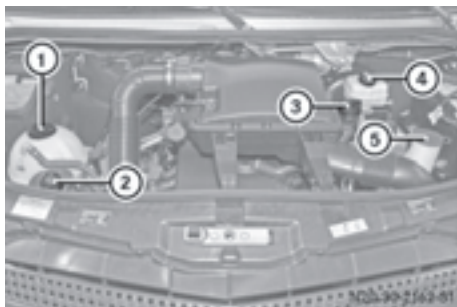

Example: engine

- ① Coolant expansion tank cap (> page 222)
- ② DEF filler neck cap (> page 129)
- ③ Engine oil filler neck cap (> page 220)
- ④ Brake fluid expansion tank cap (> page 223)
- ⑤ Washer fluid reservoir cap (> page 224)

Regularly check the fluid level and the assembly for leaks. If you detect fluid loss, e.g. oil flecks on the vehicle parking space, consult a qualified specialist workshop immediately.

Engine oil

General notes

! Engine oil gets dirty in the course of operation and its quality and volume are gradually diminished. Regularly check the oil level, and top up or have it replaced as needed.

Observe the information on engine oils and oil consumption in the "Technical data" section (> page 280).



You can check the oil level in the engine:

- on the display of the on-board computer
- with the oil dipstick

Checking the oil level shown in the display

If at extremely low temperatures no engine oil level is displayed after 5 minutes, repeat the engine oil level check after another 5 minutes. If an oil level reading is still not displayed, check the engine oil level with the dipstick (> page 22.1). Have the engine oil level checked at a qualified specialist workshop.

Only check the oil level when the engine is at normal operating temperature.

- ▶ Park the vehicle on a level surface.
- ▶ Switch off the engine.
- ▶ Wait 5 minutes.
- ▶ Turn the key to position **2** in the ignition lock. The display is activated.
- ▶ **Vehicles without steering wheel buttons:** press the **(M)** menu button on the instrument cluster (> page 32) repeatedly until the display shows the  symbol. The **--:--** display message appears in the display while the engine oil level measurement is running.
- ▶ **Vehicles with steering wheel buttons:** press the **(S)** service button on the instrument cluster (> page 32). The ** Engine oil level Measuring in progress** display message appears in the display while the engine oil level measurement is in progress.

Display message for vehicles without steering-wheel buttons: the display may show the following messages after the engine oil level measurement.

	Action
OK	▶ Do not add oil.
- 1.0 qts	▶ Add the amount of oil shown (> page 222).
- 1.5 qts	▶ Check the engine oil level again after a few minutes.
- 2.0 qts	
HI	The oil level is too high. ▶ Have excess oil removed.

Measurement units in the display:

- **qts** USA only
- **ltr** Canada only

Display message for vehicles with steering-wheel buttons: the display may show the following messages after the engine oil level measurement.

	Action
Engine oil level OK	▶ Do not add oil.

Engine oil Add 1.0 quart	<ul style="list-style-type: none"> ▶ Add the amount of oil shown (▷ page 222). ▶ Check the engine oil level again after a few minutes.
Engine oil Add 1.5 quarts	
Engine oil Add 2.0 quarts	
Engine oil level Reduce oil level	<p>The oil level is too high.</p> <ul style="list-style-type: none"> ▶ Have excess oil removed.
Eng. oil lev. Turn ignition on for level	<ul style="list-style-type: none"> ▶ Turn the key to position 2 in the ignition lock.
Observe wait. period	<ul style="list-style-type: none"> ▶ Repeat the engine oil measurement after about 5 minutes if the engine is at normal operating temperature. ▶ Repeat the engine oil measurement after about 30 minutes if the engine is not at normal operating temperature.
Engine oil level Not when eng. running	<ul style="list-style-type: none"> ▶ Switch off the engine when it is at normal operating temperature and wait approximately 5 minutes before measuring the engine oil level.

Measurement units in the display:

- **qts** USA only
- **ltr** Canada only

Checking the oil level using the oil dipstick



Example: 4-cylinder diesel engine

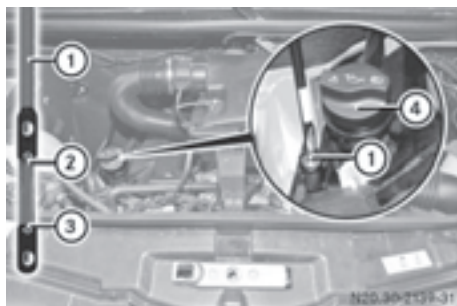

Example: 6-cylinder diesel engine

For vehicles with a red oil dipstick, only check the oil level when the engine is at normal operating temperature:

- ▶ Stop your vehicle as far away from traffic as possible on level ground.
- ▶ Secure the vehicle to prevent it from rolling away.
- ▶ Switch off the engine.
- ▶ Wait 5 minutes.

For vehicles with a yellow oil dipstick, only check the oil level when the engine is cold.

- ▶ Stop your vehicle as far away from traffic as possible on level ground.
- ▶ Secure the vehicle to prevent it from rolling away.
- ▶ Open the hood (▷ page 218).
- ▶ Pull out oil dipstick ①.
- ▶ Wipe oil dipstick ① using a lint-free cloth.

- ▶ Insert oil dipstick ① back into the guide tube as far as it will go and remove it again. If the level is between minimum mark ③ and maximum mark ②, the oil level is correct.
- ▶ If the oil level has dropped to or below minimum mark ③, open cap ④ and add engine oil (▷ page 222). The difference in quantity between marks ② and ③ is approximately 2 qt (2 l).
- ▶ Insert the oil dipstick into the guide tube as far as it will go.
- ▶ Close the hood (▷ page 219).

OM651 4-cylinder diesel engine:

At outside temperatures between 32 °F (-0 °C) and 86 °F (30 °C), the oil level can be checked when the engine is cold.

Measuring the engine oil when the engine is cold is less precise than measuring when the engine is at normal operating temperature.

When the appropriate warning is shown in the display

- ▶ Add engine oil (▷ page 222)
- or
- ▶ Have engine oil siphoned off.

Adding engine oil

WARNING

If engine oil comes into contact with hot components in the engine compartment, it may ignite. There is a risk of fire and injury.

Make sure that engine oil is not spilled next to the filler neck. Let the engine cool down and thoroughly clean the engine oil off the components before starting the engine.

- ❗ The alternator is located below the engine oil filler neck. If engine oil spills onto the alternator, there is a danger of alternator damage. Be very careful when adding engine oil.

Environmental note

When adding oil, take care not to spill any. If oil enters the soil or waterways, it is harmful to the environment.

- ❗ Do not add too much oil. Adding too much engine oil can result in damage to the engine or to the catalytic converter. Have excess engine oil siphoned off.

- ❗ Do not use any additives in the engine oil. This could damage the engine.
- ▶ Open the hood (▷ page 218).
- ▶ Unscrew and remove cap ④.
- ▶ Add engine oil.
- ▶ Replace cap ④ on the filler neck and tighten. When doing so, make sure that the cap engages correctly.
- ▶ Check the oil level with the oil dipstick (▷ page 221) or on the display (▷ page 220).
- ▶ Close the hood.

Coolant

WARNING

The engine cooling system is pressurized, particularly when the engine is warm. When opening the cap, you could be scalded by hot coolant spraying out. There is a risk of injury.

Let the engine cool down before opening the cap. Wear eye and hand protection when opening the cap. Open the cap slowly half a turn to allow pressure to escape.

Only check the coolant level and/or fill the coolant if the vehicle is on a level surface and the engine has cooled down. The coolant temperature must be below 122 °F (50 °C).

- ❗ Check the engine cooling and heating system regularly for leaks.

If a large quantity of coolant is lost, have the cause traced and rectified at a qualified specialist workshop.

WARNING

If antifreeze comes into contact with hot components in the engine compartment, it may ignite. There is a risk of fire and injury.

Let the engine cool down before you add antifreeze. Make sure that antifreeze is not spilled next to the filler neck. Thoroughly clean the antifreeze from components before starting the engine.

- ❗ Take care not to spill any coolant on painted surfaces. You could otherwise damage the paintwork.



Example: cap and coolant expansion tank

Checking the coolant level

- ▶ Stop your vehicle as far away from traffic as possible on level ground.
- ▶ Switch off the engine.
- ▶ Secure the vehicle to prevent it from rolling away.
- ▶ Open the hood (▷ page 218).
- ▶ Slowly turn cap ① half a turn counter-clockwise to allow excess pressure to escape.
- ▶ Turn cap ① further and remove it.
- ▶ Check the coolant level.
If the coolant reaches the maximum mark on coolant expansion tank ②, there is enough coolant in coolant expansion tank ②.

Adding coolant

- ▶ If the coolant drops under the minimum mark on coolant expansion tank ②, add coolant to the maximum mark.
Observe the information on coolant mixture ratio and water quality in the "Technical data" section (▷ page 283). To prevent damage to the engine cooling system, use only approved corrosion inhibitor and antifreeze that complies with the Mercedes-Benz Specifications for Service Products.
- ▶ Replace cap ① and turn it clockwise to tighten.
- ▶ Start the engine.
- ▶ After approximately 5 minutes, switch off the engine and allow it to cool down.
- ▶ Check the coolant level again and add coolant if necessary.
- ▶ Close the hood.

Brake fluid

⚠ WARNING

Service products may be poisonous and hazardous to health. There is a risk of injury.

Comply with instructions on the use, storage and disposal of service products on the labels of the respective original containers. Always store service products sealed in their original containers. Always keep service products out of the reach of children.

Brake fluid is hazardous to health. Also observe the safety notes in the "Service products and capacities" section (▷ page 277).

⚠ WARNING

The brake fluid constantly absorbs moisture from the air. This lowers the boiling point of the brake fluid. If the boiling point of the brake fluid is too low, vapor pockets may form in the brake system when the brakes are applied hard. This would impair braking efficiency. There is a risk of an accident.

You should have the brake fluid renewed at the specified intervals.

❗ Brake fluid corrodes paint, plastic and rubber. If paint, plastic or rubber has come into contact with brake fluid, rinse with water immediately.

Have the brake fluid renewed every 2 years at a qualified specialist workshop. Observe the information on brake fluid in the "Technical data" section (▷ page 283).

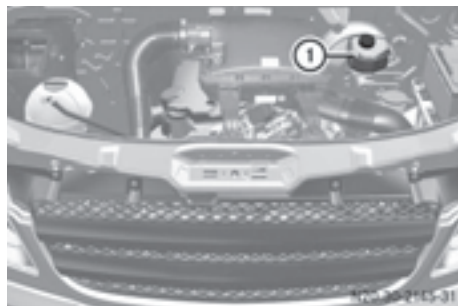

Check the brake fluid level regularly, e.g. weekly or when refueling.

Checking the brake fluid level

- ▶ Stop your vehicle as far away from traffic as possible on level ground.
- ▶ Switch off the engine.
- ▶ Secure the vehicle to prevent it from rolling away.
- ▶ Open the hood (▷ page 218).
- ▶ Check the brake fluid level.
The brake fluid level is correct if the level is between the MIN mark and MAX mark on brake fluid reservoir ①.
- ▶ Close the hood.

! If the brake fluid level in the brake fluid reservoir has fallen to the MIN mark or below, check the brake system immediately for leaks. Also check the thickness of the brake linings. Visit a qualified specialist workshop immediately.

Do not add brake fluid. This does not correct the malfunction.

Washer fluid

WARNING

Windshield washer concentrate could ignite if it comes into contact with hot engine components or the exhaust system. There is a risk of fire and injury.

Make sure that no windshield washer concentrate is spilled next to the filler neck.

! Only use washer fluid that is suitable for plastic lamp lenses, e.g. MB SummerFit or MB WinterFit. Unsuitable washer fluid could damage the plastic lenses of the headlamps.

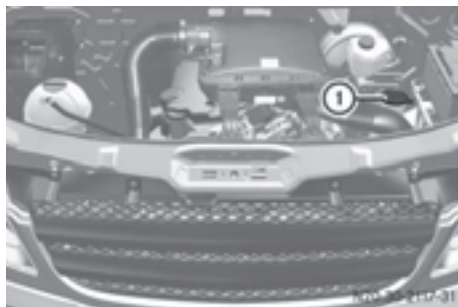

Example: washer fluid reservoir

Add windshield washer concentrate to the washer fluid all year round. Observe the information on washer fluid in the "Technical data" section (▷ page 284).

Adding washer fluid

- ▶ Mix the washer fluid to the appropriate mixing ratio in a container beforehand.
- ▶ Open the hood (▷ page 218).
- ▶ Pull cap ① on the washer fluid reservoir upwards at the tab.
- ▶ Add the premixed washer fluid.
- ▶ Press cap ① onto the filler neck until it engages audibly.
- ▶ Close the hood.

Fuel system

Draining the fuel filter

WARNING

Fuel is highly flammable. Improper handling of fuel creates a risk of fire and explosion.

Avoid fire, open flames, smoking and creating sparks under all circumstances. Switch off the ignition and auxiliary heating before carrying out work to the fuel system. Always wear protective gloves.

Environmental note

Dispose of the water-fuel mixture in an environmentally responsible manner.

! When the  indicator lamp lights up, drain the fuel filter with water separator immediately. Otherwise, the engine may be damaged.

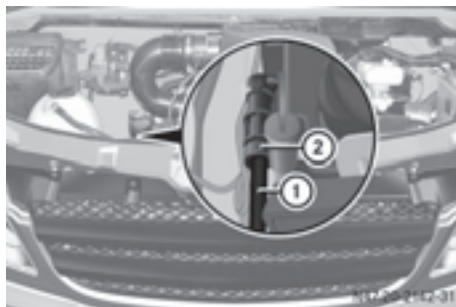

If the  indicator lamp in the instrument cluster goes on, drain fuel filter with water separator ③ immediately.

i We recommend that you have this maintenance work carried out at a qualified specialist workshop.

- ▶ Park the vehicle safely and secure it from rolling away.
- ▶ Switch off the auxiliary heating system .
- ▶ Switch off the engine.
- ▶ Open the hood (▷ page 218).
- ▶ Place a suitable receptacle under drain hose ①.
- ▶ Turn the key to position **2** in the ignition lock.
- ▶ Open drain plug ② immediately until the water/fuel mixture flows out of drain hose ①.
- ▶ Screw in drain plug ② as soon as approximately 0.2 qt (0.2 l) of the water/fuel mixture has been collected.
The electrical fuel pump automatically halts the flow of the water/fuel mixture after 30 seconds.
- ▶ After draining, turn the key back to position **0** in the ignition lock.
- ▶ Dispose of the collected water/fuel mixture in an environmentally responsible manner, e.g. at a qualified specialist workshop.
- ▶ Check drain plug ②. The drain plug must be closed.
When the engine is running and drain hose ② is open, fuel is lost through drain hose ①.
- ▶ Close the hood (▷ page 219).

If the  indicator lamp does not go out after draining:

- ▶ Drain the fuel filter again.
- ▶ If the  indicator lamp does not go out after draining for the second time, have the cause checked immediately at a qualified specialist workshop.

Vehicle interior

Air filter for the rear-compartment air conditioning

- I** Regularly check the air filters for visible dirt. Clean or replace a dirty filter mat. The dirt may otherwise lead to damage to the air-conditioning system.



Filter magazine, located on the roof in the rear compartment

An increased amount of sand or dust may collect in the air filter of the rear-compartment air conditioning when you drive on dusty or sandy roads.

- ▶ **To remove the filter mat:** carefully pry cover ① out of recesses ② and remove.
- ▶ Remove the filter mat from the air duct.
- ▶ **To clean the filter mat:** wash the dirty filter mat with clear water.
- ▶ Leave the filter mat to dry.
- i** The filter mat must not be cleaned or dried in a machine.
- ▶ **To install the filter mat:** insert the filter mat into the air duct.
- ▶ Replace and engage cover ①.

Maintenance

General notes

Environmental note

Observe measures to protect the environment when working on the vehicle. You must observe the legal requirements when disposing of service products, e.g. engine oil. This also includes all components, e.g. filters, which have come into contact with service products. Any qualified specialist workshop can provide information about this.

Dispose of empty containers, cleaning cloths and care products in an environmentally responsible manner. Comply with the instructions for use of the care products.

Do not run the engine for longer than necessary when the vehicle is stationary.

Before having maintenance and repairs performed, it is essential to read the materials related to the maintenance and repairs:

- the applicable sections of the technical documentation, e.g. the Operator's Manual and workshop information.
- regulations such as industrial safety regulations and accident prevention regulations.

While working under the vehicle, you must secure the vehicle on jack stands with sufficient load capacity.

Never use the jack as a substitute. The vehicle's jack is intended only to raise the vehicle for a short time when changing a wheel. It is not suited for performing maintenance work under the vehicle.

Please also refer to the notes about qualified specialist workshops (> page 26).

The scope and regularity of the inspection and maintenance work primarily depend on the often diverse operating conditions. Specialist knowledge beyond the scope of this Operator's Manual is required when carrying out testing and maintenance work. This work should only be carried out by trained staff.

The vehicle Maintenance Booklet describes the scope and frequency of maintenance work and contains additional notes on the New Vehicle Limited Warranty and on service products.

Maintenance services must be carried out in accordance with the provisions and recommendations in the Maintenance Booklet. Not doing so could void the warranty claim and lead to refusal of goodwill gestures after the manufacturer has submitted a damage report.

-  Observe the notes on genuine Sprinter parts (> page 28).

Service interval display

General notes

A service that is due is displayed in the service interval display about 1 month in advance. A message is then displayed while the vehicle is in motion or when the ignition is switched on.

-  The service interval display does not provide information about the engine oil level. The

service interval display should therefore not be confused with the  engine oil level display.

The service due date is displayed in days or miles (kilometers), depending on the total distance driven.



The symbols or letters on the service display show the type of service that is due.

 or **A** for a minor service



 or **B** for a major service

Service due date display

Vehicles with steering wheel buttons: the following messages may be displayed.

-  Service A due in ... days
-  Service A due in ... mi (km)
-  Service A Carry out now



Vehicles without steering wheel buttons: the following messages may be displayed.



-  for service A
-  for Service B

Additionally, you will see the remaining distance in miles (**mi**) or kilometers (**km**) or the remaining time in days (**d**).

Service due date has been exceeded

Vehicles with steering wheel buttons: if you have missed the service due date, one of the following messages appears in the display and warning tone also sounds.



-  Service A overdue by ... days
-  Service A overdue by ... km (km)

Vehicles without steering wheel buttons: if you have missed the service due date, the  or  symbol for the service flashes for 10 seconds after the ignition is switched on. A minus sign also appears in front of the service due date.

Calling up the service due date







- ▶ Turn the key to position **2** in the ignition lock. The display is activated.

Vehicles without steering wheel buttons

- ▶ Press the  menu button on the instrument cluster repeatedly until the  or  symbol for the service appears in the display.

Additionally, you will see the remaining distance in miles (mi) or kilometers (km) or the remaining time in days (d).

Vehicles with steering wheel buttons

- ▶ Press the  or  button on the steering wheel until the standard display (> page 167) appears in the display.
- ▶ Press the  or  button on the steering wheel repeatedly until the service message appears in the display, for example:
 -  Service A in ... days
 -  Service A in ... mi (km)

Battery

Important safety notes

Work on the battery, e.g. removing or installing, requires specialist knowledge and the use of special tools. Therefore, always have work on the battery carried out at a qualified specialist workshop.

 **WARNING**

Work carried out incorrectly on the battery can lead, for example, to a short circuit and thus damage the vehicle electronics. This can lead to function restrictions applying to safety-relevant systems, e.g. the lighting system, ABS (anti-lock braking system) or ESP® (Electronic Stability Program). The operating safety of your vehicle may be restricted. You could lose control of the vehicle, for example:

- braking
- in the event of abrupt steering maneuver and/or when the vehicle's speed is not adapted to the road conditions

There is a risk of an accident.

In the event of a short circuit or a similar incident, contact a qualified specialist workshop immediately. Do not drive any further. You should have all work involving the battery carried out at a qualified specialist workshop.

Further information can be found under "ABS" (> page 53) and under "ESP®" (> page 54).

 **WARNING**

Electrostatic build-up can lead to the creation of sparks, which could ignite the highly explosive gases of a battery. There is a risk of an explosion.

Before handling the battery, touch the vehicle body to remove any existing electrostatic build-up.

The flammable gas mix is produced when the battery is charged or when the vehicle is jump-started.

Always make sure that neither you nor the battery are electrostatically charged. Electrostatic charging results, for example, from:

- wearing synthetic clothing
- friction between clothing and the seat
- dragging or pushing the battery across carpet flooring or any other synthetic materials
- rubbing the battery with cloths or towels.

Comply with the following safety precautions and take protective measures when handling batteries.



Risk of explosion. Explosive oxyhydrogen is produced when batteries are being charged. Only charge batteries in well-ventilated areas.



Fire, open flames and smoking are therefore prohibited when working on the battery. Avoid creating sparks.



Battery acid is caustic. Avoid contact with the skin, eyes or clothing. Wear acid-proof protective gloves. If skin or clothes are splashed with acid, neutralize the splashes immediately with soapy water or an acid neutralizer, and then clean the affected areas with water. Consult a doctor if necessary.



Wear eye protection. When mixing water and acid, the liquid can splash into your eyes. Rinse acid splashes to the eyes immediately with clean water and contact a doctor immediately.



Keep children at a safe distance. Children are not able to assess the

dangers posed by batteries and acid.



When handling batteries, observe the safety precautions and special protective measures contained in this Operator's Manual.

Environmental note



Batteries contain dangerous substances. It is against the law to dispose of them with the household rubbish. They must be collected separately and recycled to protect the environment.



Dispose of batteries in an environmentally friendly manner. Take discharged batteries to a qualified specialist workshop or a special collection point for used batteries.

Observe the following notes:

- Recharge the battery more frequently, if you:
 - predominantly drive short distances
 - predominantly drive at low outside temperatures
 - park the vehicle longer than three weeks

In order for the batteries to achieve their maximum possible service life, they must always be sufficiently charged.

- When you park the vehicle, remove the key if you do not require any electrical consumers. The vehicle will then use very little energy, thus conserving battery power.
- When replacing a battery, only use batteries that are recommended for use in Sprinter vehicles.
- Have the battery removed at a qualified specialist workshop.
- If you leave your vehicle parked your vehicle longer than three weeks:
 - consult a qualified specialist workshop or
 - switch off the power supply using the battery main switch (> page 118) or
 - disconnect the batteries (> page 229).

Otherwise, you need to check the battery's condition of charge every three weeks, since

standby power consumption can drain the battery. If the battery voltage is lower than 12.2 V, the battery must be charged. Otherwise, the battery may be damaged by exhaustive discharging.

Be sure to observe the notes on charging the batteries (> page 232).

Installation locations

Your vehicle may be equipped with three batteries, depending on the equipment version:

- Starter battery in the battery case in the left footwell
- Additional battery in the engine compartment
- Auxiliary battery under the left-hand front seat

Have the auxiliary battery removed at a qualified specialist workshop.

Installing/removing the floor covering (starter battery)

WARNING

Objects in the driver's footwell can restrict the pedal travel or obstruct a depressed pedal. The operating and road safety of the vehicle is jeopardized. There is a risk of an accident.

Make sure that all objects in the vehicle are stowed correctly, and that they cannot enter the driver's footwell. Install the floor mats securely and as specified in order to ensure sufficient clearance for the pedals. Do not use loose floor mats and do not place floor mats on top of one another.

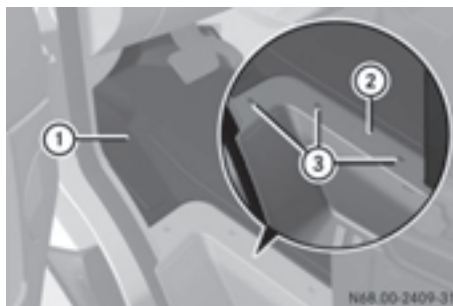

N6R 00-2409-31

- ▶ Switch off all electrical consumers.
- ▶ **To remove:** remove screws ③ and take off trim ②.
- ▶ Remove floor covering ①.
- ▶ **To install:** insert floor covering ① and align with the driver's seat base and the doorway.
- ▶ Put trim ② in place and screw screws ③ back in.

Disconnecting/connecting the starter battery

Important safety notes

WARNING

During the charging process, a battery produces hydrogen gas. If a short circuit occurs or sparks are created, the hydrogen gas can ignite. There is a risk of an explosion.

- Make sure that the positive terminal of a connected battery does not come into contact with vehicle parts.
- Never place metal objects or tools on a battery.
- It is important that you observe the described order of the battery terminals when connecting and disconnecting a battery.
- When jump-starting, make sure that the battery poles with identical polarity are connected.
- It is particularly important to observe the described order when connecting and disconnecting the jumper cables.
- Never connect or disconnect the battery terminals while the engine is running.

Disconnecting the starter battery

- ▶ **!** Switch off the engine and remove the key from the ignition lock. Firstly remove the battery terminals. Otherwise, you could destroy electronic components such as the alternator.

Always disconnect the starter battery in the battery case in the left-hand side footwell first.

- ▶ **!** Always disconnect the battery in the order described below. Never swap the terminal clamps. You may otherwise damage the vehicle electronics.

If the vehicle is expected to be out of use for over 3 weeks, disconnect the batteries. This will prevent battery discharge caused by off-load current consumption.

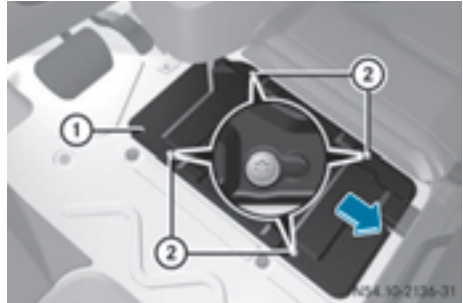

Battery cover in the left footwell

- ▶ Switch off all electrical consumers.
- ▶ Switch off the engine and remove the key from the ignition lock.
- ▶ Remove the floor covering (▷ page 228).
- ▶ Loosen screws ② and slide battery cover ① in the direction of the arrow. The screws must protrude beyond the larger recesses.
- ▶ Remove battery cover ① upwards.

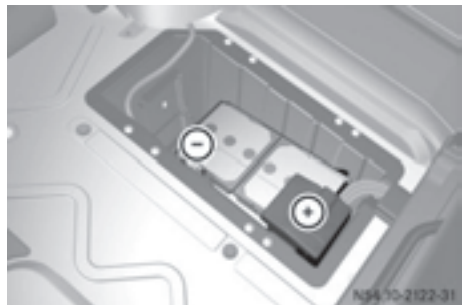

Starter battery in the left footwell

- ▶ First loosen and remove the negative terminal clamp so that it is no longer in contact with the terminal.
- ▶ Remove the cover from the positive terminal.
- ▶ Loosen the positive terminal clamp and fold it up to the side together with the pre-fuse box.

Reconnecting the starter battery

! Always connect the battery in the order described below. Never swap the terminal clamps. You may otherwise damage the vehicle electronics.

- ▶ Fold the positive terminal clamp with the pre-fuse box down to the terminal.
- ▶ Connect the positive terminal clamp.
- ▶ Attach the cover to the positive terminal.
- ▶ Connect the negative terminal clamp.
- ▶ Position battery cover ① so that screws ② are positioned over the large recesses.
- ▶ Slide battery cover ① in the direction of travel into the smaller recesses.
- ▶ Tighten screws ②.
- ▶ Install the floor covering (▷ page 228).

Carry out the following work after connecting the battery:

- ▶ Reset the side windows (▷ page 71).

Removing/installing the starter battery

Removing the starter battery



- ▶ Disconnect the battery (▷ page 229).
- ▶ Pull breather hose with connector bracket ② from connection ① on the degassing cover.

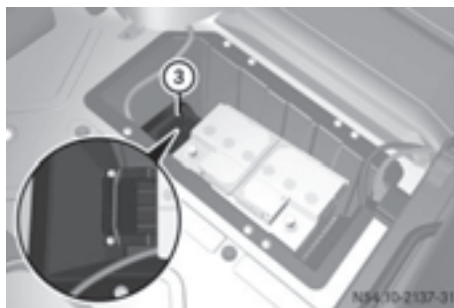

- ▶ Loosen the bolts holding retainer ③, which prevents the battery from moving around.

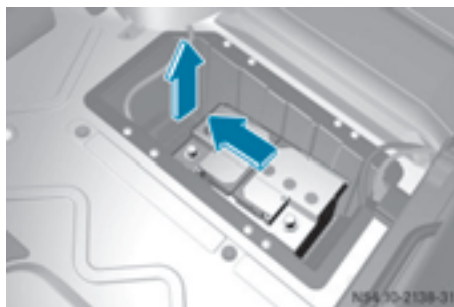

- ▶ Pull retainer ③ upwards.
- ▶ Slide the battery from its anchorage in the direction of travel.
- ▶ Fold the bar of the battery upwards and remove the battery from the battery case.

Installing the starter battery

- ▶ Insert the battery into the battery case.
- ▶ Fold down the bar of the battery.
- ▶ Slide the battery into its anchorage in the opposite direction to the direction of travel.
- ▶ Insert retainer ③.
- ▶ Tighten the bolts on retainer ③ which holds the battery in place.
- ▶ Attach breather hose with connector bracket ② to connection ① of the ventilation cover.
- ▶ Connect the battery (▷ page 229).

Disconnecting and connecting the additional battery (engine compartment)

Important safety notes

WARNING

During the charging process, a battery produces hydrogen gas. If a short circuit occurs or sparks are created, the hydrogen gas can ignite. There is a risk of an explosion.

- ▶ Make sure that the positive terminal of a connected battery does not come into contact with vehicle parts.
- ▶ Never place metal objects or tools on a battery.
- ▶ It is important that you observe the described order of the battery terminals when connecting and disconnecting a battery.
- ▶ When jump-starting, make sure that the battery poles with identical polarity are connected.
- ▶ It is particularly important to observe the described order when connecting and disconnecting the jumper cables.
- ▶ Never connect or disconnect the battery terminals while the engine is running.

Disconnecting the additional battery

 Switch off the engine and remove the key from the ignition lock. Firstly remove the battery terminals. Otherwise, you could destroy electronic components such as the alternator.

Always disconnect the starter battery in the battery case in the left-hand side footwell first.

 Always disconnect the battery in the order described below. Never swap the terminal clamps. You may otherwise damage the vehicle electronics.

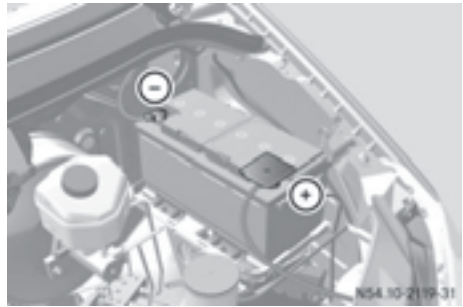

Additional battery in the engine compartment

- ▶ Switch off all electrical consumers.
- ▶ Switch off the engine and remove the key from the ignition lock.
- ▶ Open the hood (▷ page 2 18).
- ▶ First loosen and remove the negative terminal clamp so that it is no longer in contact with the terminal.
- ▶ Remove the cover from the positive terminal.
- ▶ Loosen and remove the positive terminal clamp.

Connecting the additional battery

 Always connect the battery in the order described below. Never swap the terminal clamps. You may otherwise damage the vehicle electronics.

- ▶ Connect the positive terminal clamp.
- ▶ Attach the cover to the positive terminal.
- ▶ Connect the negative terminal clamp.
- ▶ Close the hood.

Carry out the following work after connecting the battery:

- ▶ Reset the side windows (▷ page 71).

Installing and removing the additional battery (engine compartment)

Removing the additional battery

- ▶ Disconnect the battery (▷ page 231).
- ▶ Loosen the bolts holding the retainer that prevents the battery from moving around.
- ▶ Remove the battery holder and take out the battery.

Installing the additional battery

- ▶ Insert the battery into the battery case.
- ▶ Insert the battery holder.
- ▶ Tighten the bolts holding the retainer that prevents the battery in the engine compartment from moving around.
- ▶ Connect the battery (▶ page 231).

Charging

WARNING

A discharged battery can freeze at temperatures below freezing point. When jump-starting the vehicle or charging the battery, gases can escape from the battery. There is a risk of an explosion.

Allow the frozen battery to thaw out before charging it or jump-starting.

If the indicator/warning lamps do not light up in the instrument cluster when temperatures are low, it is probably because the discharged battery has frozen. Should this be the case, do not jump-start the vehicle or charge the battery. The service life of a thawed battery may be shorter. Start-up behavior may deteriorate, in particular at low temperatures. Have the thawed battery checked at a qualified specialist workshop.

WARNING

During charging and jump-starting, explosive gases can escape from the battery. There is a risk of an explosion.

Particularly avoid fire, open flames, creating sparks and smoking. Ensure there is sufficient ventilation while charging and jump-starting. Do not lean over a battery.

WARNING

Battery acid is caustic. There is a risk of injury. Avoid contact with skin, eyes or clothing. Do not inhale any battery gases. Do not lean over the battery. Keep children away from batteries. Wash away battery acid immediately with plenty of clean water and seek medical attention.

-  Only charge the installed battery with a battery charger that has been tested and approved by the distributor named on the inside of the front cover. This device allows the battery to be charged when it is installed in the vehicle. The vehicle's electronics may otherwise be damaged.

A battery charger unit specially adapted for Mercedes-Benz vehicles and tested and approved by Mercedes-Benz is available as an accessory. Only this device permits the charging of the battery in its installed position. Only charge the installed battery with a battery charger that has been tested and approved by Mercedes-Benz, using the jump-start connection point in the engine compartment. Contact an authorized Mercedes-Benz Center for information and availability. Read the operating instructions for your charger before charging the battery.



The additional battery cannot be charged from the jump-starting connection point.

Recharge the battery more frequently if you use the vehicle mainly for short trips and/or drive at low outside temperatures.

- ▶ Charge the battery. Observe the notes in the operating instructions for your battery charger.
- ▶ If necessary, install battery. Observe the notes on reconnecting the battery.

-  Recharge uninstalled, out of service batteries every three months. This will counter self-discharging and prevent battery damage.

Care

-  Dirty battery clamps and battery surfaces cause leak currents which lead to the batteries discharging.
-  Do not use cleaning agents containing fuel. Cleaning agents containing fuel corrode the battery housing.
-  If dirt gets into the battery cell, battery self-discharge will increase and the battery may be damaged.

The following points on battery care must be observed:

- ▶ Regularly check the battery terminals and the fastening of the negative cable to the chassis to ensure that they are firmly seated.
- ▶ Always keep the battery terminals and battery surfaces clean and dry.
- ▶ Lightly grease the undersides of the battery terminals with acid-resistant grease.
- ▶ Only clean the battery casing with a commercially available cleaning product.

Care

Notes on care

WARNING

If you use openings in the bodywork or detachable parts as steps, you could:

- slip and/or fall
- damage the vehicle and cause yourself to fall.

There is a risk of injury.

Always use secure climbing aids, e.g. a suitable ladder.

! For cleaning your vehicle, do not use any of the following:

- dry, rough or hard cloths
- abrasive cleaning agents
- solvents
- cleaning agents containing solvents

Do not scrub.

Do not touch the surfaces or protective films with hard objects, e.g. a ring or ice scraper. You could otherwise scratch or damage the surfaces and protective film.

! Do not park the vehicle for an extended period straight after cleaning it, particularly after having cleaned the wheels with wheel cleaner. Wheel cleaners could cause increased corrosion of the brake discs and brake pads/linings. For this reason, you should drive for a few minutes after cleaning. Braking heats the brake discs and the brake pads/linings, thus drying them. The vehicle can then be parked.

Environmental note

Only clean your vehicle at specially designed wash bays. Dispose of empty containers and used cleaning products in an environmentally responsible manner.

Environmental note

Dispose of empty packaging and cleaning cloths in an environmentally responsible manner.

Regular care of your vehicle is a condition for retaining the quality in the long term.

Use care products and cleaning agents recommended and approved by Mercedes-Benz.

Use care products and cleaning agents recommended and approved for Sprinter vehicles.

Washing the vehicle and cleaning the paintwork

Automatic car wash

WARNING

Braking efficiency is reduced after washing the vehicle. There is a risk of an accident.

After the vehicle has been washed, brake carefully while paying attention to the traffic conditions until full braking power is restored.

! Never clean your vehicle in a Touchless Automatic Car Wash as these use special cleaning agents. These cleaning agents can damage the paintwork or plastic parts.

! Make sure that the automatic car wash is suitable for the size of the vehicle.

Before washing the vehicle in an automatic car wash, fold in the exterior mirrors and remove any additional antennas. Otherwise, the exterior mirror, antenna or the vehicle itself could be damaged.

Make sure that the exterior mirrors are fully folded out again and that any additional antennas are re-installed when you leave the automatic car wash.

! Make sure that:

- the side windows and the roof are completely closed
- the climate control blower is switched off
- the windshield wiper switch is at position **0**

The vehicle could otherwise be damaged.

You can wash the vehicle in an automatic car wash from the very start.

Wash off excess dirt before cleaning the vehicle in an automatic car wash.

After putting the vehicle through an automatic car wash, wipe off wax from:

- the rear view camera lens (▷ page 236)
- the windshield
- the windshield wiper blades

This will prevent smears and reduce wiping noises caused by residue on the windshield.

Washing by hand

In some countries, washing by hand is only allowed at specially equipped washing bays. Observe the legal requirements of the country you are currently in when washing by hand.

- ▶ Do not use hot water and do not wash the vehicle in direct sunlight.
- ▶ Use a soft car sponge.
- ▶ Use a mild cleaning agent, e.g. a car shampoo approved for use with Sprinter vehicles.
- ▶ Thoroughly hose down the vehicle with a gentle jet of water.
- ▶ Do not point the water jet directly towards the air inlets.
- ▶ Use plenty of water and rinse out the sponge frequently.
- ▶ Rinse the vehicle with clean water and dry thoroughly with a chamois.
- ▶ Do not let the cleaning agents dry on the paintwork.

When using the vehicle in winter, remove all traces of road salt deposits carefully and as soon as possible.

Power washers

WARNING

The water jet from a circular jet nozzle (dirt blasters) can cause invisible exterior damage to the tires or chassis components. Compo-

nents damaged in this way may fail unexpectedly. There is a risk of an accident.

Do not use power washers with circular jet nozzles to clean the vehicle. Have damaged tires or chassis components replaced immediately.

! Under no circumstances use power washers in the vehicle interior. The pressurized water and associated spray produced by the power washer could cause extensive damage to the vehicle.

! Observe the minimum distance to be maintained between the nozzle of the power washer and object to be cleaned, as outlined below:

- approximately 2.2 ft (70 cm) when using round-jet nozzles
- approximately 1 ft (30 cm) when using 25° flat-spray jets and dirt blasters

Keep the water jet moving while cleaning. To avoid causing damage, do not point the water jet directly at:

- door joints
 - brake hoses
 - electrical components
 - electrical connections
 - seals
 - drive train, especially not at the intermediate bearing of the propeller shaft
 - rear view camera (camera lens and microphone opening on the bottom)
- Keep a minimum distance of 1.6 ft (50 cm).

Cleaning the engine

! Water must not enter intake or ventilation openings. When cleaning with high pressure water or steam cleaners, the spray must not be aimed directly at electrical components or the terminals of electrical lines.

Preserve the engine after the engine has been cleaned. Protect the belt drive system from exposure to the preservative agent.

Also observe the information under "Power washers" (▷ page 234).

Cleaning the paintwork

! Do not affix:

- stickers
 - films
 - magnetic plates or similar items
- to painted surfaces. You could otherwise damage the paintwork.

Scratches, corrosive deposits, areas affected by corrosion and damage caused by inadequate care cannot always be completely repaired. In such cases, visit a qualified specialist workshop.

- ▶ Remove impurities immediately, where possible, whilst avoiding rubbing too hard.
- ▶ Soak insect remains with insect remover and rinse off the treated areas afterwards.
- ▶ Soak bird droppings with water and rinse off the treated areas afterwards.
- ▶ Remove coolant, brake fluid, tree resin, oils, fuels and greases by rubbing gently with a cloth soaked in petroleum ether or lighter fluid.
- ▶ Use tar remover to remove tar stains.
- ▶ Use silicone remover to remove wax.

Cleaning the windows

WARNING

You could become trapped by the windshield wipers if they start moving while cleaning the windshield or wiper blades. There is a risk of injury.

Always switch off the windshield wipers and the ignition before cleaning the windshield or wiper blades.

- ! Do not fold the windshield wipers away from the windshield unless the hood is closed. Otherwise, you could damage the hood.
- ! Hold the wiper arm securely when folding back. The windshield could be damaged if the wiper arm smacks against it suddenly.
- ! Do not use dry cloths, abrasive products, solvents or cleaning agents containing solvents to clean the inside of the windows. Do not touch the insides of the windows with hard objects, e.g. an ice scraper or ring. There is otherwise a risk of damaging the windows.

Before cleaning the windshield

- ▶ Turn the key to position **0** in the ignition lock or remove it.
- ▶ Fold the windshield wiper arms away from the windshield until you feel them engage. Before switching the ignition on again, fold the windshield wipers back into position.

Cleaning the windows

- ▶ Clean the inside and outside of the windows with a damp cloth and a cleaning agent that is recommended and approved for Sprinter vehicles.

Exterior

Cleaning the wheels

! Do not use any acidic or alkaline cleaning agents. They can cause corrosion on the wheel bolts (wheel nuts) or the retainer springs for the wheel-balancing weights.

! Do not park the vehicle for an extended period straight after cleaning it, particularly after having cleaned the wheels with wheel cleaner. Wheel cleaners could cause increased corrosion of the brake discs and brake pads/linings. For this reason, you should drive for a few minutes after cleaning. Braking heats the brake discs and the brake pads/linings, thus drying them. The vehicle can then be parked.

If you clean the wheels with a power washer, observe the safety notes for the power washer (▷ page 234). You could otherwise damage the tires.

Cleaning the wiper blades

WARNING

You could become trapped by the windshield wipers if they start moving while cleaning the windshield or wiper blades. There is a risk of injury.

Always switch off the windshield wipers and the ignition before cleaning the windshield or wiper blades.

- ❗ Do not fold the windshield wipers away from the windshield unless the hood is closed. Otherwise, you could damage the hood.
- ❗ Do not pull the wiper blade. Otherwise, the wiper blade could be damaged.
- ❗ Do not clean wiper blades too often and do not rub them too hard. Otherwise, the graphite coating could be damaged. This could cause wiper noise.
- ❗ Hold the wiper arm securely when folding back. The windshield could be damaged if the wiper arm smacks against it suddenly.
- ▶ Turn the key to position **0** in the ignition lock or remove it.
- ▶ Fold the windshield wiper arms away from the windshield until you feel them engage.
- ▶ Carefully clean the wiper blades with a damp cloth.
- ▶ Fold back the wiper arms before switching on the ignition.

Cleaning the exterior lighting

- ❗ Only use cleaning agents or cleaning cloths which are suitable for plastic light lenses. Unsuitable cleaning agents or cleaning cloths could scratch or damage the plastic light lenses.
- ▶ Clean the plastic covers of the exterior lighting with a damp sponge and a mild cleaning agent, e.g. car shampoo for Sprinter vehicles, or with cleaning cloths.

Cleaning the mirror turn signal

- ❗ Only use cleaning agents or cleaning cloths that are suitable for plastic lenses. Unsuitable cleaning agents or cleaning cloths could scratch or damage the plastic lenses of the mirror turn signals.
- ▶ Clean the plastic lenses of the mirror turn signals in the exterior mirror housing using a wet sponge and mild cleaning agent, e.g. car shampoo or cleaning cloths.

Cleaning the sensors

- ❗ Do not use dry, coarse or hard cloths and do not scrub. You will otherwise scratch or damage the sensors.

If you clean the sensors with a power washer or steam cleaner, observe the information provided by the manufacturer regarding the distance to be maintained between the vehicle and the nozzle of the power washer.



PARKTRONIC sensors (example: front bumper, left side of vehicle)

- ▶ Clean all sensors ① in the front and rear bumpers with water, shampoo and a soft cloth.

Cleaning the rear view camera

- ❗ Do not use dry, coarse or hard cloths and do not scrub. Otherwise, you will scratch or damage the lens of the rear-view camera.

If you clean the vehicle with a high-pressure or steam cleaner, maintain a distance of at least 1.650 cm from the rear-view camera. Do not aim directly at the rear-view camera or at the microphone opening on the underside of the rear-view camera. You could otherwise damage the rear-view camera.

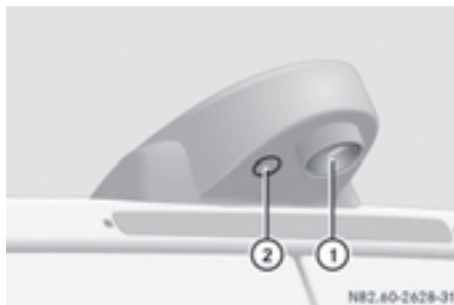

Rear view camera in the middle of the roof above the high-mounted brake lamp

- ① Camera lens
- ② Microphone openings

- ▶ Clean camera lens ① with clean water and a soft cloth.

Make sure that you do not apply any wax to camera lens ① when waxing the vehicle. If necessary, remove the wax using water, shampoo and a soft cloth.

Cleaning the sliding door

- ▶ Remove foreign objects from the vicinity of the contact surfaces and contact pins of the sliding door.
- ▶ Clean the contact surfaces and contact pins with a mild cleaning agent and a soft cloth.

Do not oil or grease the contact plates and contact pins.

Steps

Cleaning the electrical step

Clean the electrical step at least once a month. Make sure that no dirt accumulates in the housing or on the step.

- ▶ Extend the electrical step (▷ page 66).
- ▶ Close the sliding door until the door lock engages.
The electrical step remains extended for cleaning.
- ▶ Clean the electrical step and the housing with a power washer.
- ▶ After cleaning, spray the step guides on each side with silicone spray when the housing and electrical step are dry.
Do not use oil or grease as a lubricant.
- ▶ Retract the electrical step.

Access step in the bumper



Example: access step in the bumper

Pay attention to the important safety notes in the "Notes on care" (▷ page 233) and "Power washers" (▷ page 234) sections.

Keep step in the bumper ① free from dirt, such as:

- mud
 - clay
 - snow
 - ice
- ▶ Clean access step in the bumper ① with a power washer.

Cleaning the trailer tow hitch

❗ Do not clean the ball coupling with a power washer. Do not use solvents.

❗ Observe the notes on care in the Operator's Manual for the trailer tow hitch and the ball coupling manufacturer.

You can also have the maintenance work on the ball coupling and the trailer tow hitch carried out by a qualified specialist workshop.

Interior

Cleaning the interior

❗ When using liquids to clean the vehicle interior, observe the following points:

- Under no circumstances use power washers.
- Make sure that no fluids enter or remain in gaps and cavities.
- Ensure sufficient ventilation when cleaning.
- Make sure that the vehicle interior is completely dry after cleaning.

Cleaning the display

❗ For cleaning, do not use any of the following:

- alcohol-based thinner or gasoline
- abrasive cleaning agents
- commercially-available household cleaning agents

These may damage the display surface. Do not put pressure on the display surface when cleaning. This could lead to irreparable damage to the display.

- ▶ Switch off the audio equipment and let the display cool down.
- ▶ Clean the display surface with a commercially available microfiber cloth and cleaner for TFT/LCD displays.
- ▶ Dry the display surface using a dry microfiber cloth.

Cleaning the plastic trim

WARNING

Care products and cleaning agents containing solvents cause surfaces in the cockpit to become porous. As a result, plastic parts may come loose in the event of air bag deployment. There is a risk of injury.

Do not use any care products and cleaning agents to clean the cockpit.

Do not affix the following to plastic surfaces:

- stickers
- films
- scented oil bottles or similar items

You can otherwise damage the plastic.

Do not allow cosmetics, insect repellent or sunscreen to come into contact with the plastic trim. This maintains the high-quality look of the surfaces.

- ▶ Wipe the plastic trim and the cockpit with a damp, lint-free cloth, e.g. a microfiber cloth.
- ▶ **Heavy soiling:** use a mild detergent or care products and cleaning agents recommended and approved by Mercedes-Benz.

Cleaning the steering wheel and selector lever

- ▶ Thoroughly wipe with a damp cloth.

Cleaning the trim elements

-  Do not use solvent-based cleaning agents such as tar remover, wheel cleaners, polishes or waxes. There is otherwise a risk of damaging the surface.

- ▶ Wipe the trim elements with a damp, lint-free cloth, e.g. a microfiber cloth.
- ▶ **Heavy soiling:** use care products and cleaning agents recommended and approved for Sprinter vehicles.

Cleaning the seat covers

-  Do not use microfiber cloths to clean artificial leather covers. If used often, a microfiber cloth can damage the cover.

Clean:

- artificial leather covers with a cloth moistened with a solution containing 1% detergent, e.g. dish washing liquid.
- cloth covers with a microfiber cloth moistened with a solution containing 1% detergent, e.g. dish washing liquid. Wipe entire seat sections carefully to avoid leaving visible lines. Leave the seat to dry afterwards. Cleaning results depend on the type of dirt and how long it has been there.

Cleaning the seat belts

WARNING

Seat belts can become severely weakened if bleached or dyed. This could cause the seat belts to tear or fail, for instance, in the event of an accident. This poses an increased risk of injury or fatal injury.

Never bleach or dye the seat belts.

-  Do not clean the seat belts using chemical cleaning agents. Do not dry the seat belts by heating at temperatures above 176 °F (80 °C) or in direct sunlight.

Remove any stains or dirt immediately. This will avoid residue or damage.

- ▶ Use clean, lukewarm water and soap solution.

Cleaning the headliner

- ▶ Use a soft brush or dry shampoo to remove heavy soiling.

Cleaning the curtains

- ❗ The curtains must not be washed. Washing could cause the curtains to shrink and lose their fire-retardant properties. Always have the curtains dry-cleaned.

Useful information

This Operator's Manual describes all models as well as standard and optional equipment of your vehicle that were available at the time of going to print. Country-specific variations are possible. Note that your vehicle may not be equipped with all of the described functions. This also applies to systems and functions relevant to safety.

Read the information on qualified specialist workshops (▷ page 26).

Where will I find...?

Vehicle tool kit

General notes

The vehicle tool kit is in the stowage compartment in the footwell on the front-passenger side.

The vehicle tool kit consists of:

- a towing eye
- a screwdriver with Torx, Phillips and slotted bits

If your vehicle is equipped with a spare wheel bracket and a jack, the vehicle tool kit additionally contains:

- a wheel wrench
- a spanner
- a pump lever rod

i The maximum payload of the jack can be found on the sticker on the jack itself.

The jack is maintenance-free. In the event of a malfunction, please contact a qualified specialist workshop.

Stowage compartment in the front-passenger footwell



Unlocking and removing the cover

- ▶ Turn quick-release fastener (1) counter-clockwise or clockwise (2).
- ▶ Slightly raise and pull out the cover.

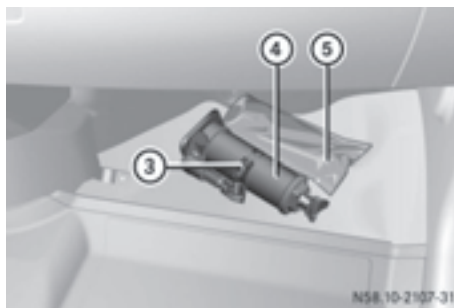

Removing the vehicle tool kit and the jack

- ▶ Remove vehicle tool kit (5).
- ▶ Pull up quick-release lever (3) and unhook the retaining strap of jack (4).
- ▶ Lift jack (4) upwards out of the holder.

i When stowing away the jack, place it in the holder as shown in the illustration. Make sure that the retaining strap of the jack is hooked in and tensioned.

Inserting and engaging the cover

- ▶ Slide in the cover and fold it down.
- ▶ Press down quick-release fastener (1) until it engages.

Warning triangle and warning lamp

Removing the warning lamp

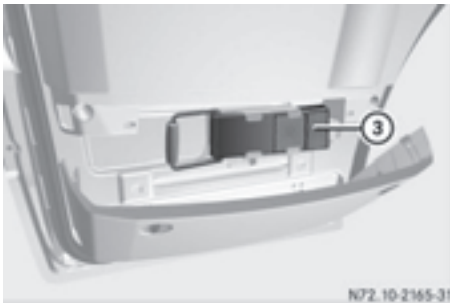
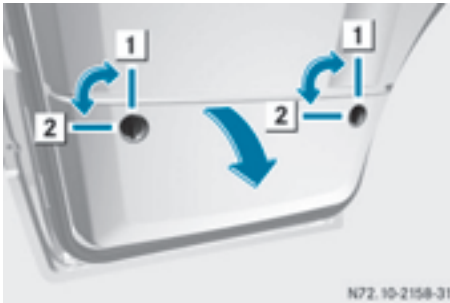

- ▶ Turn the quick-release fasteners to position **2**.
The cover is unlocked.
- ▶ Lift up the cover.
- ▶ Take warning lamp **3** out of the retainer.
- ▶ Fold the cover up and turn the quick-release fasteners to position **1**.
The cover is locked.

Removing the warning triangle

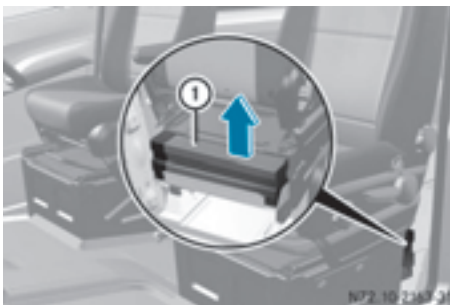

Warning triangles at the back of the driver's seat base

- ▶ Lift warning triangle **1** up and out of the bracket.

First-aid kit

Removing the first-aid kit

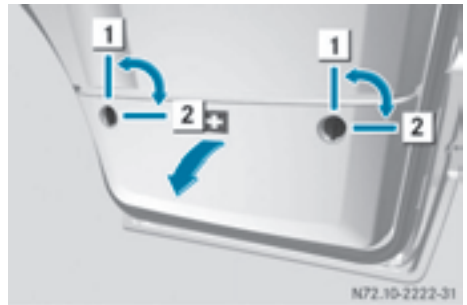

- ▶ Turn the quick-release fasteners to position **2**.
The cover is unlocked.
 - ▶ Lift up the cover.
 - ▶ Take first-aid kit **3** out of the retainer.
 - ▶ Fold the cover up and turn the quick-release fasteners to position **1**.
The cover is locked.
- i** Check the expiration date on the first-aid kit at least once a year. Replace any expired or missing contents.

Fire extinguisher

Removing the fire extinguisher

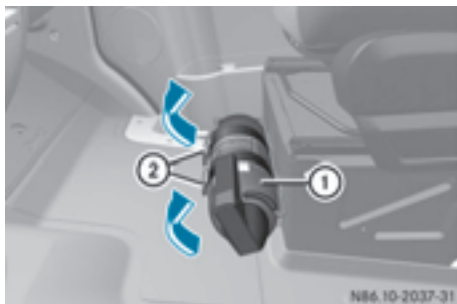

Fire extinguisher at the front of the base of the co-driver's seat

- ▶ Pull tabs ② upwards.
- ▶ Take fire extinguisher ① out of its holder.

Please read the instructions on fire extinguisher ① carefully and familiarize yourself with its operation. Have fire extinguisher ① refilled after each use and checked every one or two years. It may otherwise fail in an emergency. Observe the legal requirements for each individual country.

Flat tire

Information on breakdown assistance in the case of a flat tire can be found in the chapter "Wheels and tires" (▷ page 266).

Jump-starting

Important safety notes

⚠ WARNING

During charging and jump-starting, explosive gases can escape from the battery. There is a risk of an explosion.

Particularly avoid fire, open flames, creating sparks and smoking. Ensure there is sufficient ventilation while charging and jump-starting. Do not lean over a battery.

⚠ WARNING

Battery acid is caustic. There is a risk of injury. Avoid contact with the skin, eyes or clothing. Do not inhale any battery gases. Do not lean over the battery. Keep children away from batteries. Wash battery acid immediately with water and seek medical attention.

Do not use a rapid charging device to start the vehicle. If your vehicle's battery is discharged, the engine can be jump-started from another vehicle or from a donor battery using jumper cables. For this purpose, the vehicle has a jump-starting connection point in the engine compartment.

The additional battery in the engine compartment is not suitable for jump-starting operations. If your vehicle requires jump-starting, or if you use it to jump-start another vehicle, use the jump-starting connection point in the engine compartment.

When jump-starting, observe the following points:

- The battery is not accessible in all vehicles. If the other vehicle's battery is not accessible, jump-start the vehicle using a donor battery or a jump-starting device.
- Do not start the engine if the battery is frozen. Let the battery thaw first.
- Jump-starting may only be performed from batteries with a nominal voltage of 12 V.
- Only use jumper cables that have a sufficient cross-section and insulated terminal clamps.
- If the battery is fully discharged, attach the battery of another vehicle for a few minutes before attempting to start. This charges the empty battery a little.
- Make sure that the two vehicles do not touch.

Make sure that:

- the jumper cables are not damaged.
- bare parts of the terminal clamps do not come into contact with other metal parts while the jumper cables are connected to the battery.
- the jumper cables cannot come into contact with parts such as the V-belt pulley or the fan. These parts move when the engine is started and while it is running.

i Jumper cables and further information regarding jump starting can be obtained at any qualified specialist workshop.

Before connecting the jumper cables

On vehicles with a battery main switch, check whether the battery main switch is switched on (▷ page 118).

- ▶ Apply the parking brake.
- ▶ Move the selector lever of the automatic transmission to position **P**.
- ▶ Switch off all electrical consumers, e.g. audio equipment, blower.
- ▶ Turn the key to position **0** in the ignition lock and remove it (▷ page 119).
- ▶ Open the hood (▷ page 218).

Tow-starting and towing away**Important safety notes** **WARNING**

Functions relevant to safety are restricted or no longer available if:

- the engine is not running.
- the brake system or the power steering is malfunctioning.
- there is a malfunction in the voltage supply or the vehicle's electrical system.

If your vehicle is being towed, much more force may be necessary to steer or brake. There is a risk of an accident.

In such cases, use a tow bar. Before towing, make sure that the steering moves freely.

 **WARNING**

You can no longer steer the vehicle if the steering wheel lock has been engaged. There is a risk of an accident.

Always switch off the ignition when towing the vehicle with a tow cable or a tow bar.

 **WARNING**

When towing or tow-starting another vehicle and its weight is greater than the permissible gross weight of your vehicle, the:

- the towing eye could detach itself
- the vehicle/trailer combination could roll-over.

There is a risk of an accident.

When towing or tow-starting another vehicle, its weight should not be greater than the permissible gross weight of your vehicle.

Information on the gross vehicle weight can be found on the vehicle identification plate (▷ page 276).

 Only secure the tow rope or tow bar at the towing eyes. Otherwise, the vehicle could be damaged.

 Observe the following points when towing with a tow rope:

- Secure the tow rope on the same side on both vehicles.
- Ensure that the tow cable is not longer than legally permitted. Mark the tow cable in the middle, e.g. with a white cloth (30 x 30 cm). This will make other road users aware that the vehicle is being towed.
- Only secure the tow cable to the towing eye.
- Observe the brake lamps of the towing vehicle while driving. Always maintain a distance so that the tow rope does not sag.
- Do not use steel cables or chains to tow your vehicle. You could otherwise damage the vehicle.

 Do not use the towing eye for recovery, this could damage the vehicle. In if doubt, recover the vehicle with a crane.

 When towing, pull away slowly and smoothly. If the tractive power is too high, the vehicles could be damaged.

When towing away, you must observe the legal requirements for the country in which you are currently driving.

It is preferable to have the vehicle transported on a transporter or trailer instead of towing it.

The automatic transmission selector lever must be in the **N** position when towing the vehicle.

The battery must be connected and charged. Otherwise, you:

- cannot turn the key in the ignition lock to position **2**
- cannot move the selector lever to position **N** on vehicles with automatic transmission

Before the vehicle is towed, switch off the automatic locking feature (▷ page 64). You could otherwise lock yourself out of the vehicle when pushing or towing away the vehicle.

Installing/removing the towing eye



The fixture for the front towing eye is located in the bumper.



Rear towing eye under the bumper, attached to the chassis

Your vehicle may be equipped with rear towing eye ②. If you tow or tow-start a vehicle, attach the towing device to rear towing eye ②.

If your vehicle is equipped with a trailer tow hitch, attach the towing device to the trailer tow hitch (▷ page 155).

Installing the front towing eye

- ▶ Take the towing eye and screwdriver from the vehicle tool kit (▷ page 240).
- ▶ Press cover ① and remove cover ① from the opening.
You will see the fixture for the towing eye.
- ▶ Screw in the towing eye clockwise to the stop.
- ▶ Insert screwdriver into the towing eye and tighten it.

Removing the front towing eye

- ▶ Remove the screwdriver from the vehicle tool kit.
- ▶ Insert the screwdriver into the towing eye and turn the screwdriver counter-clockwise.
- ▶ Unscrew the towing eye.
- ▶ Insert cover ① with the lug at the bottom and press it in at the top until it engages.
- ▶ Place the towing eye and screwdriver back in the vehicle tool kit.

Towing away in the event of malfunctions

Front or rear axle damage on all-wheel-drive vehicles

- ⚠ For vehicles with all-wheel drive, all four wheels must be raised for towing away. Otherwise, you may damage the transfer case.
If the vehicle can only be raised by the front axle, you must remove the propeller shaft between the rear axle and the transfer case. Always use new bolts when installing the propeller shaft.

If the vehicle has front or rear axle damage, have it transported on a transporter or trailer.

With transmission damage

- ⚠ Always use new bolts when installing the propeller shafts.
- i Only have the propeller shafts fitted or removed by qualified, skilled personnel.

If the vehicle has transmission damage, have the propeller shaft removed before towing away.

Towing with the front or rear axle raised

General notes

! The ignition must be switched off if the vehicle is being towed with the front or rear axle raised. Otherwise, ESP® may intervene and damage the brake system.

! Always use new bolts when installing the propeller shafts.

i Only have the propeller shafts installed and removed by qualified, skilled personnel.

Observe the following before towing a vehicle with a raised front or rear axle:

- the information on towing in the event of malfunctions (▷ page 244) and
- the important safety notes (▷ page 243).

If the front axle is damaged, raise the vehicle at the front axle and if the rear axle is damaged, raise the vehicle at the rear axle.

Towing

If the front axle is raised, the vehicle may be towed a maximum of 30 miles (50 km). For a towing distance of over 30 miles (50 km), the propeller shafts to the driven axles must be removed.

- ▶ Turn the key to position **2** in the ignition lock.
- ▶ Depress the brake pedal and keep it depressed.
- ▶ Shift the automatic transmission to position **N**.
- ▶ Turn the key to position **1** in the ignition lock and leave it in this position.
- ▶ Switch on the hazard warning lamps (▷ page 82).
- ▶ Release the brake pedal.
- ▶ Release the parking brake.
- ▶ If the front axle is raised, do not exceed the towing speed of 30 mph (50 km/h) and the towing distance of 30 miles (50 km).

Towing the vehicle with both axles on the ground

Important safety notes

WARNING

You can no longer steer the vehicle if the steering wheel lock has been engaged. There is a risk of an accident.

Always switch off the ignition when towing the vehicle with a tow cable or a tow bar.

! Do not exceed a towing speed of 31 mph (50 km/h). You could otherwise damage the transmission.

i Only have the propeller shafts fitted and removed by qualified, skilled personnel.

Before towing the vehicle, observe the following:

- the information on towing in the event of malfunctions (▷ page 244) and
- the important safety notes (▷ page 243).

Towing

You may only tow the vehicle a maximum distance of 30 miles (50 km). For a towing distance of over 30 miles (50 km), the propeller shafts to the driven axles must be removed.

- ▶ Turn the key to position **2** in the ignition lock.
- ▶ Depress the brake pedal and keep it depressed.
- ▶ Shift the automatic transmission to position **N**.
- ▶ Release the brake pedal.
- ▶ Release the parking brake.
- ▶ Leave the key in position **2** in the ignition lock.
- ▶ Switch on the hazard warning lamps (▷ page 82).
- ▶ Do not exceed the towing speed of 30 mph (50 km/h) and the towing distance of 30 miles (50 km).

Recovering a vehicle that is stuck

! When recovering a vehicle that has become stuck, pull it as smoothly and evenly as possible. Excessive tractive power could damage the vehicles.

If the drive wheels get trapped on loose or muddy ground, recover the vehicle with the utmost care. This is especially the case if the vehicle is laden.

Never attempt to recover a vehicle with a trailer attached.

Pull out the vehicle backwards, if possible, using the tracks it made when it became stuck.

Transporting the vehicle

- ❗ You may only secure the vehicle by the wheels, not by parts of the vehicle such as axle or steering components. Otherwise, the vehicle could be damaged.

Tow-starting (emergency engine starting)

Vehicles with automatic transmission

- ❗ Vehicles with automatic transmission must not be tow-started. You could otherwise damage the automatic transmission.

You can find information on jump-starting under "Jump-starting" (▷ page 242).

Electrical fuses

The fuse allocation chart and further information on the electric fuses and relays can be found in the "Fuse allocation chart" supplement.

Useful information

This Operator's Manual describes all models as well as standard and optional equipment of your vehicle that were available at the time of going to print. Country-specific variations are possible. Note that your vehicle may not be equipped with all of the described functions. This also applies to systems and functions relevant to safety.

Read the information on qualified specialist workshops (▷ page 26).

Important safety notes

Warning

A flat tire severely impairs the driving, steering and braking characteristics of the vehicle. There is a risk of an accident.

do not drive with a flat tire. Immediately replace the flat tire with your spare wheel, or consult a qualified specialist workshop.

WARNING

If wheels and tires of the wrong size are used, the wheel brakes or suspension components may be damaged. There is a risk of an accident.

Always replace wheels and tires with those that fulfill the specifications of the original part.

When replacing wheels, make sure to use the correct:

- designation
- model

When replacing tires, make sure to use the correct:

- designation
- manufacturer
- model

Accessories that are not approved for your vehicle by Mercedes-Benz or are not being used correctly can impair operating safety.

Before purchasing and using non-approved accessories, visit a qualified specialist workshop and inquire about:

- suitability
- legal stipulations
- factory recommendations

Contact an authorized Sprinter dealer if you require information on tested and recommended wheels and tires for summer and winter driving. Advice on purchasing and caring for tires is also available there.

Information on tire and wheel dimensions and types as well as the recommended tire pressure for your vehicle can be found in the "Tire pressure" section (▷ page 257).

This data can also be found on the Tire and Loading Information placard on the B-pillar.

Modifications to the brake system or wheels are not permitted. The use of wheel spacers or brake dust shields is not permitted. This invalidates the general operating permit for the vehicle.

-  Further information on wheels and tires can be obtained at any qualified specialist workshop.

Operation

Information for a journey

If the vehicle is heavily laden, check the tire pressures, and correct them, if necessary (▷ page 250).

While driving, pay attention to vibrations, noises and unusual handling characteristics, e.g. pulling to one side. This may indicate that the wheels or tires are damaged. If you suspect that a tire is defective, reduce your speed immediately. Stop the vehicle as soon as possible to check the wheels and tires for damage. Hidden tire damage could also be causing the unusual handling characteristics. If you find no signs of damage, have the tires and wheels checked at a qualified specialist workshop.

When parking your vehicle, make sure that the tires do not get deformed by the curb or other obstacles. If it is necessary to drive over curbs, speed humps or similar elevations, try to do so slowly and not at a sharp angle. Otherwise, the tires, particularly the sidewalls, can get damaged.

Regular wheel and tire checks

WARNING

Damaged tires can cause tire inflation pressure loss. As a result, you could lose control of your vehicle. There is a risk of accident.

Check the tires regularly for signs of damage and replace any damaged tires immediately.

Check the wheels and tires of your vehicle for damage regularly, i.e. at least every two weeks, as well as after driving off-road or on rough roads. Damaged wheels can cause a loss of tire pressure. Pay particular attention to damage such as:

- cuts in the tires
- punctures
- tears in the tires
- bulges on tires
- deformation or severe corrosion on wheels

Regularly check the tire tread depth and the condition of the tread across the whole width of the tire (> page 248). If necessary, turn the front wheels to full lock in order to inspect the inner side of the tire surface.

All wheels must have a valve cap to protect the valve against dirt and moisture. Do not install anything onto the valve other than the standard valve cap or other valve caps approved for your vehicle by dealers listed on the inside of the front cover. Do not install any other valve caps or systems, e.g. tire pressure monitor systems.

Regularly check the pressure of all the tires, particularly prior to long trips. Adjust the tire pressure if necessary (> page 250).

The service life of tires depends on various factors, including the following:

- driving style
- tire pressure
- mileage

Tire tread

WARNING

Insufficient tire tread will reduce tire traction. The tire is no longer able to dissipate water. This means that on wet road surfaces, the risk of hydroplaning increases, in particular where

speed is not adapted to suit the driving conditions. There is a risk of accident.

If the tire pressure is too high or too low, tires may exhibit different levels of wear at different locations on the tire tread. Thus, you should regularly check the tread depth and the condition of the tread across the entire width of all tires.

Minimum tire tread depth for:

- Summer tires: $\frac{1}{8}$ in (3 mm)
- M+S tires: $\frac{1}{6}$ in (4 mm)

For safety reasons, replace the tires before the legally prescribed limit for the minimum tire tread depth is reached.

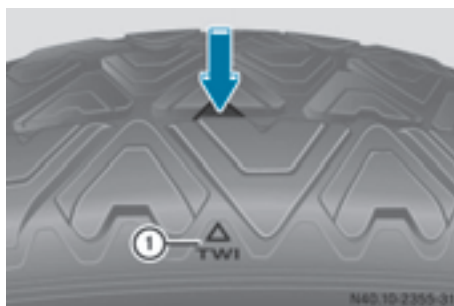

Bar marking ① for tread wear is integrated into the tire tread.

Tread wear indicators (TWIs) are required by law. Six indicators are positioned over the tire tread. They are visible once the tread depth is approximately $\frac{1}{16}$ in (1.6 mm). If this is the case, the tire is so worn that it must be replaced.

Selecting, mounting and renewing tires

- Only mount tires and wheels of the same type and make.
- Only mount tires of the correct size onto the wheels.
- Break in new tires at moderate speeds for the first 65 miles (100 km).

- Do not drive with tires which have too little tread depth, as this significantly reduces the traction on wet roads (hydroplaning).
- Replace the tires after 6 years at the latest, regardless of wear. This also applies to the spare wheel.

Operation in winter

General notes

Have your vehicle winterproofed at a qualified specialist workshop at the onset of winter.

Prior to the onset of winter, ensure that snow chains are stowed in the vehicle (▷ page 249).

Also observe the notes in the "Changing a wheel" section (▷ page 266).

Driving with summer tires

At temperatures below 45 °F (+7 °C), summer tires lose elasticity and therefore traction and braking power. Change the tires on your vehicle to M+S tire. Using summer tires at very cold temperatures could cause tears to form, thereby damaging the tires permanently. We cannot accept responsibility for this type of damage.

M+S tires

WARNING

Wheel and tire dimensions as well as the type of tire can vary between the spare wheel and the wheel to be replaced. When the spare wheel is mounted, driving characteristics may be severely affected. There is a risk of an accident.

In order to reduce risks:

- you should therefore adapt your driving style and drive carefully.
- never mount more than one spare wheel that differs from the wheel to be replaced.
- only use a spare wheel that differs from the wheel to be replaced for a short time.

- do not deactivate ESP®.
- have a spare wheel that differs from the wheel that has been changed replaced at the nearest qualified specialist workshop. You must observe the correct wheel and tire dimensions as well as the wheel type.

WARNING

M+S tires with a tire tread depth of less than 1/8 in (4 mm) are not suitable for use in winter and do not provide sufficient traction. There is a risk of an accident.

M+S tires with a tread depth of less than 1/8 in (4 mm) must be replaced immediately.

Use winter tires or all-season tires at temperatures below 45 °F (+7 °C). Both types of tire are identified by the M+S marking.

Only winter tires bearing the  snowflake symbol in addition to the M+S marking provide the best possible grip in wintry road conditions. Only these tires will allow driving safety systems such as ABS and ESP® to function optimally in winter. These tires have been developed specifically for driving in snow.

For safe driving, use M+S tires of the same make and tread pattern on all wheels.

Always observe the maximum permissible speed specified for the M+S tires you have mounted.

If you mount M+S tires that have a lower maximum permissible speed than that of the vehicle, affix a corresponding warning label in the driver's field of vision. You can obtain this at a qualified specialist workshop.

Once you have mounted the winter tires:

- ▶ Check the tire pressure (▷ page 250).
- ▶ Reactivate the tire pressure monitor* (▷ page 255).

Snow chains

WARNING

If you drive too fast with snow chains mounted, they may snap. As a result, you could injure others and damage the vehicle. There is a risk of an accident.

Observe the maximum permissible speed for operation with snow chains.

When driving with snow chains installed, do not exceed the maximum permissible speed of 30 mph (50 km/h). Observe the country-specific laws and regulations for operation with snow chains.

! Check the snow chains for damage before mounting them. Damaged or worn snow chains may snap and damage the following components:

- wheel
- wheel housing
- wheel suspension

For this reason, you must use only snow chains that are free of defects. Observe the manufacturer's mounting instructions.

! **Vehicles with steel wheels:** if you mount snow chains on steel wheels, you may damage the hub caps. Remove the hub caps from the relevant wheels before mounting the snow chains.

Snow chains increase traction on roads in wintry conditions.

For reasons of safety we only recommend using snow chains or traction aids that are approved for the Sprinter. The snow chains or traction aids must be of class U or meet the SAE type U specification. Information on snow chains is available at any qualified specialist workshop.

When mounting snow chains, please bear the following points in mind:

- Snow chains cannot be mounted on all wheel/tire combinations. When mounting the snow chains, note the permissible tire and snow chain dimensions.
- Mount snow chains only in pairs and only to the rear wheels. On vehicles with twin tires, mount the snow chains to the outer wheels. Observe the manufacturer's mounting instructions.
- **Vehicles with all-wheel-drive:** snow chains are not permitted on the front axle. There is not sufficient space for commercially-available snow chains. Information about snow chains for all-wheel-drive vehicles can be obtained from an authorized Sprinter Dealer.
- Only use snow chains when the road is covered by a layer of snow. Remove the snow

chains as soon as possible when you come to a road that is not snow-covered.

- The use of snow chains may be restricted by local regulations. Observe the appropriate regulations before mounting snow chains.
- Activate all-wheel drive before driving off with snow chains (> page 148).
- When driving with snow chains installed, do not exceed the maximum permissible speed of 30 mph (50 km/h).
- Check the tension of the chains after a distance of approximately 0.5 miles (1.0 km).

You can deactivate ASR (> page 53) when pulling away with snow chains mounted. This allows the wheels to spin in a controlled manner, achieving an increased driving force (cutting action).

Tire pressure

Tire pressure specifications

Important safety notes

WARNING

Underinflated or overinflated tires pose the following risks:

- the tires may burst, especially as the load and vehicle speed increase.
- the tires may wear excessively and/or unevenly, which may greatly impair tire traction.
- the driving characteristics, as well as steering and braking, may be greatly impaired.

There is a risk of an accident.

Follow recommended tire inflation pressures and check the pressure of all the tires including the spare wheel:

- monthly, at least
- if the load changes
- before beginning a long journey
- under different operating conditions, e.g. off-road driving

If necessary, correct the tire pressure.

- i** The specifications shown on the sample Tire and Loading Information placard and tire

pressure plate are examples. Tire pressure data are vehicle-specific and may deviate from the data illustrated here. The tire pressure data applicable to your vehicle can be found on the Tire and Loading Information placard or tire pressure plate of your vehicle.

Environmental note

Check the tire pressure regularly, at least every 14 days.

General notes

You will find information on tire pressure for the vehicle's factory-mounted tires on the plates described here.

The recommended tire pressure can be found on the Tire and Loading Information placard⁴ or the tire pressure plate on the B-pillar on the driver's side of your vehicle.

Further information on tire pressure can be obtained at a qualified specialist workshop.

Tire and Loading Information placard

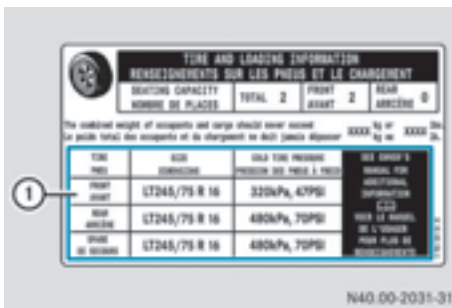

Example: Tire and Loading Information placard⁴

The Tire and Loading Information placard is on the B-pillar on the driver's side of the vehicle (▷ page 258).

The Tire and Loading Information placard contains recommended tire pressures ① for cold tires. Recommended tire pressures ① are valid for the maximum permissible load and up to the maximum permissible speed of the vehicle.

Tire pressure plate

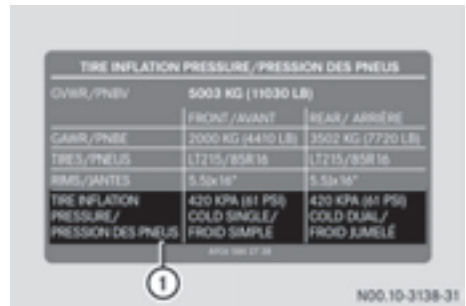

Tire pressure plate

The tire pressure plate is located on the B-pillar on the driver's side of the vehicle (▷ page 258).

The tire pressure plate contains recommended tire pressures ① for cold tires. Recommended tire pressures ① apply to the maximum permissible load and up to the maximum permissible speed of the vehicle.

Important notes on tire pressure

⚠ WARNING

If the tire pressure drops repeatedly, the wheel, valve or tire may be damaged. Tire pressure that is too low may result in a tire blow-out. There is a risk of an accident.

- Check the tire for foreign objects.
- Check whether the wheel is losing air or the valve is leaking.

If you are unable to rectify the damage, contact a qualified specialist workshop.

Use a suitable pressure gage to check the tire pressure. The outer appearance of a tire does not permit any reliable conclusion about the tire pressure. On vehicles equipped with the electronic tire pressure monitor, the tire pressure can be checked using the on-board computer. The tire temperature and pressure increase when the vehicle is in motion. This is dependent on the driving speed and the load.

Therefore, you should only correct tire pressure when the tires are cold.

⁴ Only for vehicles with a gross vehicle weight of less than 10,000 lbs (4,536 kg).

The tires are cold:

- if the vehicle has been parked for at least three hours without direct sunlight on the tires, and
- if the vehicle has not been driven further than 1 mile (1.6 km)

Tire temperature changes depending on the ambient temperature, driving speed and tire load. If the tire temperature changes by 18 °F (10 °C), the tire pressure changes by approximately 10 kPa (0.1 bar / 1.5 psi). Take this into account when checking the pressure of warm tires. Only correct the tire pressure if it is too low for the current operating conditions. If you check the tire pressures when the tires are warm, the resulting values will be higher than if the tires were cold. This is normal. Do not under any circumstances release the air in order to adjust the pressure to the prescribed value for cold tires. The tire pressure would otherwise be too low.

Observe the recommended tire pressures for cold tires:

- on the Tire and Loading Information placard⁵ on the B-pillar on the driver's side, or
- on the tire pressure plate on the B-pillar on the driver's side of the vehicle
-

Underinflated or overinflated tires

Underinflated tires:

WARNING

Tires with pressure that is too low can overheat and burst as a consequence. In addition, they also suffer from excessive and/or irregular wear, which can severely impair the braking properties and the driving characteristics. There is a risk of an accident.

Avoid tire pressures that are too low in all the tires, including the spare wheel.

Underinflated tires can:

- fail from being overheated
- adversely affect handling
- wear excessively and/or unevenly
- have an adverse effect on fuel consumption

⁵ Only for vehicles with a gross weight of less than 10,000 lbs (4,536 kg).

Overinflated tires

WARNING

Tires with excessively high pressure can burst because they are damaged more easily by road debris, potholes etc. In addition, they also suffer from irregular wear, which can severely impair the braking properties and the driving characteristics. There is a risk of an accident.

Avoid tire pressures that are too high in all the tires, including the spare wheel.

Overinflated tires can:

- increase the braking distance
- adversely affect handling
- wear excessively and/or unevenly
- adversely affect ride comfort
- be more susceptible to damage

Maximum tire pressures



- ① Maximum permitted tire pressure (example)

Never exceed the maximum permissible tire inflation pressure. When adjusting the tire pressures always observe the recommended tire pressure for your vehicle (> page 250).

-  The actual values for tires are specific to each vehicle and may deviate from the values in the illustration.

Tire valve

WARNING

Tire valve that are not approved for your vehicle by the distributor named on the inside cover page may result in a loss of tire pressure. This may affect road safety. There is a risk of an accident.

Only use tire valve that are approved for your vehicle by the distributor named on the inside cover page. Always make sure you have the correct tire valve type for the tires on your vehicle.

- !** Do not screw additional weights (check valves, etc.) onto the tire valves. The electronic components could thus be damaged.

Only for vehicles without a tire pressure monitor:

For safety reasons, Mercedes-Benz recommends that you only use tire valves that have been tested for use on your vehicle.

Checking the tire pressure manually

In order to determine and adjust the tire pressures, proceed as follows:

- ▶ Remove the valve cap of the tire you wish to check.
- ▶ Press the tire pressure gauge securely onto the valve.
- ▶ Read the tire pressure and compare it with the recommended value on the loading information table or the tire pressure table (> page 250).
- ▶ If the tire pressure is too low, increase it to the recommended value.
- ▶ If the tire pressure is too high, release air by pressing down the metal pin in the valve. Use the tip of a pen, for example. Then, check the tire pressure again using the tire pressure gauge.
- ▶ Screw the valve cap onto the valve.
- ▶ Repeat the steps for the other tires.

Tire pressure monitor

Important safety notes

WARNING

Each tire, including the spare (if provided), should be checked at least once a month when cold and inflated to the pressure recommended by the vehicle manufacturer on the Tire and Loading Information placard on the driver's door B-pillar or the tire pressure label on the inside of the fuel filler flap. If your vehicle has tires of a different size than the size indicated on the Tire and Loading Information placard or the tire pressure label, you should determine the proper tire pressure for those tires.

As an added safety feature, your vehicle has been equipped with a tire pressure monitoring system (TPMS) that illuminates a low tire pressure telltale when one or more of your tires are significantly underinflated. Accordingly, when the low tire pressure telltale illuminates, you should stop and check your tires as soon as possible, and inflate them to the proper pressure. Driving on a significantly underinflated tire causes the tire to overheat and can lead to tire failure. Underinflation also reduces fuel efficiency and tire tread life, and may affect the vehicle's handling and stopping ability.

Please note that the TPMS is not a substitute for proper tire maintenance, and it is the driver's responsibility to maintain correct tire pressure, even if underinflation has not reached the level to trigger illumination of the TPMS low tire pressure telltale.

USA only:

Your vehicle has also been equipped with a TPMS malfunction indicator to indicate if the system is not operating properly. The TPMS malfunction indicator is combined with the low tire pressure telltale. When the system detects a malfunction, the warning lamp will flash for approximately a minute and then remain continuously illuminated. This sequence will be repeated every time the vehi-

cle is started as long as the malfunction exists.

When the malfunction indicator is illuminated, the system may not be able to detect or signal low tire pressure as intended. TPMS malfunctions may occur for a variety of reasons, including the mounting of incompatible replacement or alternate tires or wheels on the vehicle that prevent the TPMS from functioning properly. Always check the TPMS malfunction telltale after replacing one or more tires or wheels on your vehicle to ensure that the replacement or alternate tires and wheels allow the TPMS to continue to function properly.

Vehicles with a tire pressure monitor are equipped with sensors in the wheels that monitor the tire pressure of all four tires. The tire pressure monitor monitors the pressure in all four tires; you set this pressure when you activate the tire pressure monitor. The tire pressure monitor warns you when the pressure drops in one or more of the tires. The tire pressure monitor only functions if the corresponding sensors are installed on all wheels.

You should always adjust the tire pressure according to the vehicle load. Restart the tire pressure monitor if you change the tire pressure.

The tire pressure monitor does not warn you if a tire pressure is incorrect. Observe the notes on the recommended tire pressure (▷ page 250).

The tire pressure monitor is not able to warn you of a sudden loss of pressure, e.g. following penetration by a foreign object. In this event, brake the vehicle until it comes to a standstill. Do not carry out any sudden steering maneuvers.



The tire pressure monitor has a yellow  warning lamp in the instrument cluster for indicating pressure loss/malfunctions (USA) or pressure loss (Canada). Depending on how the warning lamp flashes or lights up, an underinflated tire or a malfunction in the tire pressure monitor is displayed:

- if the  warning lamp is lit continuously, the tire pressure on one or more tires is sig-

nificantly too low. The tire pressure monitor is not malfunctioning.

- USA only: if the  warning lamp flashes for 60 seconds and then remains lit constantly, the tire pressure monitor is malfunctioning.

Only vehicles with steering wheel buttons: the on-board computer displays information on tire pressure. After a few minutes of driving, the current tire pressure of each tire is shown in the on-board computer.

USA only: if the tire pressure monitor is malfunctioning, it may be more than 10 minutes before the malfunction is shown. The  tire pressure warning lamp flashes for 60 seconds and then remains lit. When the malfunction has been rectified, the  tire pressure warning lamp goes out after a few minutes of driving.

The tire pressure values indicated by the on-board computer may differ from those measured at a gas station with a pressure gage. The tire pressures shown by the on-board computer refer to those measured at sea level. At high altitudes, the tire pressure values indicated by a pressure gage are higher than those shown by the on-board computer. In this case, do not reduce the tire pressures.





If radio transmitting equipment (e.g. wireless headphones, two-way radios) is operated inside the vehicle or in the vicinity of the vehicle, this can interfere with the operation of the tire pressure monitor.

Checking the tire pressure electronically (vehicles with steering wheel buttons)



Tire pressure display

Using the steering wheel buttons

- ▶ Turn the SmartKey to position **2** in the ignition lock.
- ▶ Press the  or  button repeatedly until the standard display is shown (▷ page 167).
- ▶ Press the  or  button repeatedly until the current pressure of the individual tires is shown in the display.

If the vehicle is parked for longer than 20 minutes or you then drive at less than 18 mph (30 km/h), the **Tire pres. displayed after driving for several minutes** message appears.

- i** The tire pressure value shown in the display may differ from those measured at a gas station using a pressure gage. The on-board computer will generally give you a more exact value.

Tire pressure loss warning system

Vehicles with steering wheel buttons

If the tire pressure monitor detects a pressure loss in one or more tires, the on-board computer displays the yellow **Tire pres. Adjust pres.** warning message. The  tire pressure loss warning lamp in the instrument cluster (▷ page 202) flashes for about 60 seconds and then remains lit.

The pressure of the affected tire is highlighted in yellow in the on-board computer (▷ page 176). If the tire pressure monitor detects a significant pressure loss in one or more tires, the on-board computer displays the red **Tire pres. Warning Tire defect** warning message. The  tire pressure loss warning lamp in the instrument cluster (▷ page 202) flashes for about 60 seconds and then remains lit. An additional warning tone sounds.

The pressure of the affected tire is highlighted in yellow in the on-board computer (▷ page 176).

Restarting the tire pressure monitor

When you restart the tire pressure monitor, the currently set tire pressure are taken as reference values for monitoring.

In most cases, the tire pressure monitor detects the new reference values automatically, e.g. after you have:



- changed the tire pressure
- changed wheels or tires
- installed new wheels or tires

However, you can also define reference values manually as described here.

Before restarting the tire pressure monitor:



- ▶ Set the tire pressure to the value recommended on the Tire and Loading Information placard or the tire pressure table on the B-pillar on the driver's side (▷ page 250).
Observe the notes on tire pressure when doing so (▷ page 250).
- ▶ Make sure that the tire pressure is correct on all four wheels.

Restarting the tire pressure monitor (vehicles without steering wheel buttons):





- ▶ Turn the SmartKey to position **2** in the ignition lock.
- ▶ Press the  menu button on the instrument cluster repeatedly until the display shows the following message:
+CAL- TPMS
- ▶ Press the  button on the instrument cluster.
The display shows:
OK TPMS

The tire pressure monitor activation process has begun. The tire pressures measured for the individual wheels are stored as the new reference values, provided that the tire pressure monitor considers them to be plausible.

If you wish to cancel the restart:

- ▶ Press the  button or the  menu button on the instrument cluster.
The activation process is canceled automatically if 30 seconds elapse without input.

Restarting the tire pressure monitor (vehicles with steering wheel buttons):

- ▶ Turn the key to position **2** in the ignition lock.
- ▶ Press the  or  button on the steering wheel until the standard display (▷ page 167) appears in the display.
- ▶ Press the  or  button on the steering wheel repeatedly until the current pressure of

the individual tires is displayed or the display shows the following message:

Tire pres. displayed after driving for several minutes

- ▶ Press the  reset button on the instrument cluster.

The display shows the following message:

Monitor current tire pressure?

- ▶ Press the  button on the steering wheel. The display shows the following message:

Tire pres. monitor reactivated

The tire pressure monitor activation process has begun. The tire pressures measured for the individual wheels are stored as the new reference values, provided that the tire pressure monitor considers them to be plausible.

If you wish to cancel the restart:

- ▶ Press the  button on the steering wheel.

Tire pressure table

Front axle tire pressure values: the following tire pressure values only apply to vehicles with a permissible front axle load of 3970 lbs (1801 kg), 4080 lbs (1851 kg) or 4410 lbs (2000 kg).

Tires/disc wheel	Front axle load		
	3970 lbs (1801 kg)	4080 lbs (1851 kg)	4410 lbs (2000 kg)
205/75 R 16 C 110/108R 6.5Jx16 ET62 ⁶	—	400 kPa (4.0 bar/58 psi)	420 kPa (4.2 bar/61 psi)
LT 215/85 R 16 115/112N 5.5Jx16 Half distance between centers: 4.94 in (125.5 mm)	—	380 kPa (3.8 bar/55 psi)	420 kPa (4.2 bar/61 psi)
LT 215/85 R 16 115/112Q 5.5Jx16 Half distance between centers: 4.94 in (125.5 mm)	—	380 kPa (3.8 bar/55 psi)	420 kPa (4.2 bar/61 psi)
LT 245/75 R 16 120/116N 6.5J x 16 Wheel offset: 2.13 in (54 mm)	320 kPa (3.2 bar/47 psi)	—	—
235/65 R 16 C 121N (118 R) 6.5J x 16 Spare wheel for vehicles with Super Single tires	—	380 kPa (3.8 bar/55 psi)	420 kPa (4.2 bar/61 psi)

Rear axle tire pressure values: the following tire pressure values only apply to vehicles with a permissible rear axle load of 5360 lbs (2431 kg), 7060 lbs (3202 kg) or 7720 lbs (3502 kg).

Tires/disc wheel	Rear axle load		
	5360 lbs (2431 kg)	7060 lbs (3202 kg)	7720 lbs (3502 kg)
LT 215/85 R 16 115/112N 5.5Jx16 Half distance between centers: 4.94 in (125.5 mm)	—	380 kPa (3.8 bar/55 psi)	420 kPa (4.2 bar/61 psi)
LT 215/85 R 16 115/112Q 5.5Jx16 Half distance between centers: 4.94 in (125.5 mm)	—	380 kPa (3.8 bar/55 psi)	420 kPa (4.2 bar/61 psi)
LT 245/75 R 16 120/116N 6.5J x 16 Wheel offset: 2.13 in (54 mm)	480 kPa (4.8 bar/70 psi)	—	—

⁶ Vehicles with Super Single tires

Tires/disc wheel	Rear axle load		
	5360 lbs (2431 kg)	7060 lbs (3202 kg)	7720 lbs (3502 kg)
285/65 R 16 C 128/126N (121 R) 285/65 R 16 C 128/126 N (123 R) ⁷ 8.5J x 16 ET 63	—	450 kPa (4.5 bar/65 psi)	—
235/65 R 16 C 121N (118 R) 6.5J x 16 Spare wheel for vehicles with Super Single tires	—	520 kPa (5.2 bar/75 psi)	—

Loading the vehicle

Instruction labels for tires and loads

WARNING

Overloaded tires can overheat, causing a blowout. Overloaded tires can also impair the steering and driving characteristics and lead to brake failure. There is a risk of accident.

Observe the load rating of the tires. The load rating must be at least half of the GAWR of your vehicle. Never overload the tires by exceeding the maximum load.



The Tire and Loading Information placard on the driver's door B-pillar

Two instruction labels on your vehicle show the maximum possible load.

- (1) Only for vehicles with a gross weight of less than 10,000 lbs (4,536 kg):
Tire and Loading Information placard ① is on the B-pillar on the driver's side. Tire and

Loading Information placard ① shows the permissible number of occupants and the maximum permissible load of the vehicle. It also contains details of the tire sizes and corresponding pressures for tires mounted at the factory.

- (2) The vehicle identification plate is located on the base of the driver's seat. The vehicle identification plate informs you of the gross vehicle weight rating. It is made up of the vehicle weight, all vehicle occupants, the fuel and the cargo. You can also find information about the maximum Gross Axle Weight Rating on the front and rear axle.

The maximum gross axle weight rating is the maximum weight that can be carried by one axle (front or rear axle). Do not exceed the maximum gross vehicle weight or the maximum gross axle weight rating for the front or rear axle.

Tire and Loading Information placard

General notes

Only vehicles with a gross weight of less than 10,000 lbs (4,536 kg) have a Tire and Loading Information placard on the B-pillar on the driver's side.

⁷ Super Single tires.

Maximum permissible gross vehicle weight rating

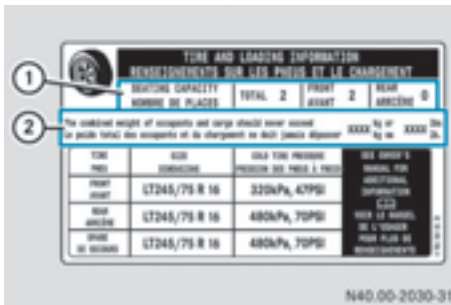

- ① Maximum number of seats
 - ② Maximum permissible gross vehicle weight rating
- ▶ Specification for maximum gross vehicle weight ② is listed in the Tire and Loading Information placard: "The gross weight of occupants and luggage must not exceed XXX kilograms or XXX lbs."

The gross weight of all vehicle occupants, cargo, luggage and trailer load/noseweight (if applicable) must not exceed the specified value.

- ① The details on the Tire and Loading Information placard illustration are only an example. The maximum permissible gross vehicle weight rating is vehicle-specific and may differ from that which is illustrated. You can find the valid maximum permissible gross vehicle weight rating for your vehicle on the Tire and Loading Information placard.

Number of seats

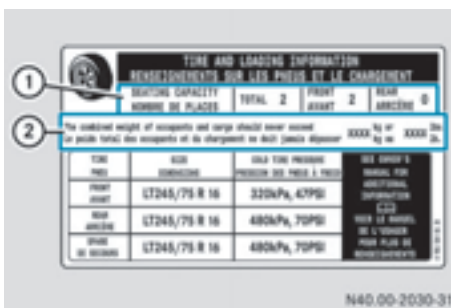

- ① Maximum number of seats
- ② Maximum permissible gross vehicle weight rating

Maximum number of seats ① determines the maximum number of occupants allowed to travel in the vehicle. This information can be found on the Tire and Loading Information placard.

- ① The details on the Tire and Loading Information placard illustration are only an example. The number of seats is vehicle-specific and can differ from the details shown. The number of seats in your vehicle can be found on the Tire and Loading Information placard.

Determining the maximum load

Individual steps

The following steps have been developed as required of all manufacturers under Title 49, Code of U.S. Federal Regulations, Part 575 in accordance with the "National Traffic and Motor Vehicle Safety Act of 1966".

- ▶ **Step 1:** Locate the statement "The combined weight of occupants and cargo should never exceed XXX kg or XXX lbs." on your vehicle's Tire and Loading Information placard.
- ▶ **Step 2:** Determine the combined weight of the driver and passengers that will be traveling in your vehicle.
- ▶ **Step 3:** Subtract the combined weight of the driver and passengers from XXX kilograms or XXX lbs.
- ▶ **Step 4:** The resulting figure equals the available amount of cargo and luggage load capacity. For example, if the "XXX" amount equals 1400 lbs and there will be five 150 pound passengers in your vehicle, the amount of available cargo and luggage load capacity is 650 lbs (1400 - 750 (5 x 150) = 650 lbs).
- ▶ **Step 5:** Determine the combined weight of luggage and cargo being loaded on the vehicle. For reasons of safety, that weight must not exceed the available cargo and luggage cargo capacity calculated in step 4.
- ▶ **Step 6 (if applicable):** If you intend to tow a trailer behind your vehicle, the load on the trailer is transferred to your vehicle. Please consult the Tire and Loading Information placard, to determine how this reduces the available cargo and luggage load capacity of your vehicle.

Example: Steps 1 to 3

The following table shows examples of how to calculate total load and cargo capacities with varying seating configurations and number and size of occupants. The following examples use a maximum load of 1500 lbs (680 kg). **This is for illustration purposes only.** Make sure you are using the actual load limit for your vehicle stated on your vehicle's Tire and Loading Information placard .

		Example 1	Example 2	Example 3
Step 1	Combined maximum weight of occupants and cargo (data from the Tire and Loading Information placard)	1500 lbs (680 kg)	1500 lbs (680 kg)	1500 lbs (680 kg)

		Example 1	Example 2	Example 3
Step 2	Number of people in the vehicle (driver and occupants)	5	3	1
	Distribution of the occupants	Front: 2 Rear: 3	Front: 1 Rear: 2	Front: 1
	Weight of the occupants	Occupant 1: 150 lbs (68 kg) Occupant 2: 180 lbs (82 kg) Occupant 3: 160 lbs (73 kg) Occupant 4: 140 lbs (63 kg) Occupant 5: 120 lbs (54 kg)	Occupant 1: 200 lbs (91 kg) Occupant 2: 190 lbs (86 kg) Occupant 3: 150 lbs (68 kg)	Occupant 1: 150 lbs (68 kg)
	Gross weight of all occupants	750 lbs (340 kg)	540 lbs (245 kg)	150 lbs (68 kg)

		Example 1	Example 2	Example 3
Step 3	Permissible cargo and trailer load/nose-weight (maximum gross vehicle weight rating from the Tire and Loading Information placard minus the gross weight of all occupants)	1500 lbs (680 kg) - 750 lbs (340 kg) = 750 lbs (340 kg)	1500 lbs (680 kg) - 540 lbs (245 kg) = 960 lbs (435 kg)	1500 lbs (680 kg) - 150 lbs (68 kg) = 1350 lbs (612 kg)

The greater the combined weight of the occupants, the lower the maximum luggage load. Further information can be found under "Towing a trailer" (▷ page 159).

Vehicle identification plate

Even if you have calculated the total cargo carefully, you should still make sure that the gross vehicle weight rating and the gross axle weight rating are not exceeded. Details about this can be found on the vehicle identification plate on the driver seat frame of your vehicle (▷ page 276).

Gross vehicle weight: the gross weight of the vehicle, all passengers, cargo and trailer load/noseweight (if applicable) must not exceed the permissible gross vehicle weight.

Gross axle weight rating: the maximum permissible load that can be carried by one axle (front or rear axle).

To ensure that your vehicle does not exceed the maximum permissible values (gross vehicle weight and maximum gross axle weight rating), have your loaded vehicle (including driver, occupants, cargo, and full trailer load if applicable) weighed on a suitable vehicle weighbridge.

Trailer load/noseweight

The trailer load/noseweight affects the gross weight of the vehicle. If a trailer is attached, the trailer load/noseweight is included in the load along with occupants and luggage. The trailer load/noseweight is usually approximately 10% of the gross weight of the trailer and its load.

What you should know about wheels and tires

Tire labeling

Overview

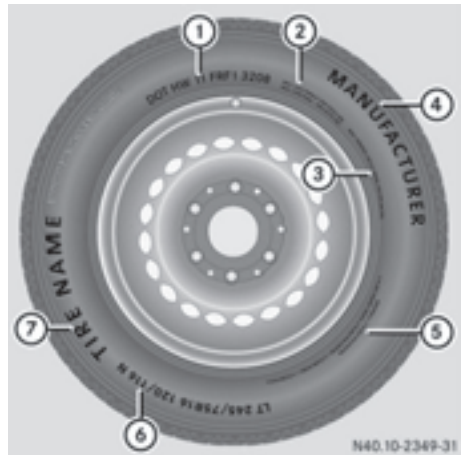

- ① DOT, Tire Identification Number (▷ page 263)
- ② Maximum tire load (▷ page 263)
- ③ Maximum tire pressure (▷ page 252)
- ④ Manufacturer
- ⑤ Tire material (▷ page 264)
- ⑥ Tire size designation, load-bearing capacity and speed index (▷ page 261)
- ⑦ Tire name

The markings described above are on the tire in addition to the tire name (sales designation) and the manufacturer's name.

i Tire data is vehicle-specific and may deviate from the data in the example.

Tire size designation, load bearing index and speed index

WARNING

Exceeding the stated tire load-bearing capacity and the approved maximum speed could lead to tire damage or the tire bursting. There is a risk of accident.

Therefore, only use tire types and sizes approved for your vehicle model. Observe the

tire load rating and speed rating required for your vehicle.



- ① Design standard
- ② Tire width
- ③ Nominal aspect ratio in %
- ④ Tire code
- ⑤ Rim diameter
- ⑥ Load bearing index
- ⑦ Speed index

General: depending on the manufacturer's standards, the size imprinted in the tire wall may not contain any letters or may contain one letter ① that precedes the size description

If "LT" precedes the size description (as shown above): these are light truck tires according to U.S. manufacturing standards.

If "C" precedes the size description: these are commercial motor vehicle tires according to European manufacturing standards.

Tire width: tire width ② shows the nominal tire width in millimeters.

Aspect ratio: aspect ratio ③ is the size ratio between the tire height and tire width and is shown in percent. The aspect ratio is calculated by dividing the tire width by the tire height.

Tire code: tire code ④ specifies the tire type. "R" represents radial tires. "D" represents diagonal tires, "B" represents diagonal radial tires.

Rim diameter: rim diameter ⑤ is the diameter of the bead seat, not the diameter of the rim flange. The rim diameter is specified in inches (in).

Load-bearing index: load-bearing index ⑥ is a numerical code that specifies the maximum load-bearing capacity of a tire.

Do not overload the tires by exceeding the specified load limit. The maximum permissible load can be found on the vehicle's Tire and

Loading Information placard on the B-pillar on the driver's side (▷ page 258).

Example:

The load-bearing index 120 indicates a maximum load of 3,042 lb (1,380 kg) for the tire. If two load-bearing capacity indices are specified (as shown above), the first number states the load-bearing capacity for single tires, the second number the load-bearing capacity for twin tires. For further information on the maximum tire load in kilograms and pounds, see (▷ page 263).

For further information on the load-bearing index, see "Load index" (▷ page 263).

Speed rating: speed rating ⑦ specifies the approved maximum speed of the tire.

Regardless of the speed index always observe the speed limits. Drive carefully and adapt your driving style to the traffic conditions.

i Tire data is vehicle-specific and may deviate from the data in the example.

Index	Speed rating
F	up to 50 mph (80 km/h)
G	up to 56 mph (90 km/h)
J	up to 62 mph (100 km/h)
K	up to 68 mph (110 km/h)
L	up to 74 mph (120 km/h)
M	up to 80 mph (130 km/h)
N	up to 87 mph (140 km/h)
P	up to 93 mph (150 km/h)
Q	up to 100 mph (160 km/h)
R	over 106 mph (170 km/h)

i Not all tires that have the M+S identification offer the driving characteristics of winter tires. In addition to the M+S marking, winter tires also have the ❄️ snowflake symbol on the tire wall. Tires with this marking fulfill the requirements of the Rubber Manufacturers Association (RMA) and the Rubber Association of Canada (RAC) regarding the tire traction on snow. They have been especially developed for driving on snow.

Further information on the reading of tire information can be obtained at any qualified specialist workshop.

Load index



In addition to the load-bearing index, load rating ① may be imprinted after the letters that identify speed rating on the sidewall of the tire (▷ page 261).

- If no specification is given: no text (as in the example above), represents a standard load (SL) tire
- XL or Extra Load: represents a reinforced tire
- Light Load: represents a light load tire
- C, D, E: represents a load range that depends on the maximum load that the tire can carry at a certain pressure

i Tire data is vehicle-specific and may deviate from the data in the example.

Maximum tire load



Maximum tire load ① is the maximum permissible weight for which the tire is approved.

Do not overload the tires by exceeding the specified load limit. The maximum permissible load can be found on the vehicle's Tire and

Loading Information placard on the B-pillar on the driver's side (▷ page 258).

i The actual values for tires are specific to each vehicle and may deviate from the values in the illustration.

DOT, Tire Identification Number (TIN)

U.S. tire regulations stipulate that every tire manufacturer or retreader must imprint a TIN in or on the sidewall of each tire produced.



The TIN is a unique identification number. The TIN enables the tire manufacturers or retreaders to inform purchasers of recalls and other safety-relevant matters. It makes it possible for the purchaser to easily identify the affected tires. The TIN is made up of manufacturer identification code ②, tire size ③, tire type code ④ and manufacturing date ⑤.

DOT (Department of Transportation): tire symbol ① indicates that the tire complies with the requirements of the U.S. Department of Transportation.

Manufacturer identification code: manufacturer identification code ② provides details on the tire manufacturer. New tires have a code with two symbols. Retreaded tires have a code with four symbols.

Further information about retreaded tires (▷ page 247).

Tire size: identifier ③ describes the tire size.

Tire type code: tire type code ④ can be used by the manufacturer as a code to describe specific characteristics of the tire.

Date of manufacture: date of manufacture ⑤ provides information about the age of a tire. The first and second positions represent the week of manufacture, starting with "01" for the first calendar week. Positions three and four represent the year of manufacture. For example, a tire that

is marked with "3208", was manufactured in week 32 in 2008.

- i** Tire data is vehicle-specific and may deviate from the data in the example.

Tire characteristics



This information describes the type of tire cord and the number of layers in sidewall ① and under tire tread ②.

- i** Tire data is vehicle-specific and may deviate from the data in the example.

Definitions for tires and loading

Tire structure and characteristics

Describes the number of layers or the number of rubber-coated belts in the tire tread and the tire wall. These consist of steel, nylon, polyester, and other materials.

Bar

Metric unit for tire pressure. 14.5038 pounds per square inch (psi) and 100 kilopascals (kPa) are the equivalent of 1 bar.

DOT (Department of Transportation)

DOT marked tires fulfill the requirements of the United States Department of Transportation.

Average weight of vehicle occupants

The number of occupants for which the vehicle is designed multiplied by 68 kilograms (150 lbs).

Uniform Tire Quality Grading Standards

A uniform standard to grade the quality of tires with regard to tread quality, traction and temperature characteristics. The quality grading assessment is made by the manufacturer fol-

lowing specifications from the U.S government. The quality grade of a tire is imprinted on the sidewall of the tire.

Recommended tire pressure

The recommended tire pressures are the pressures specified for the tires mounted on the vehicle at the factory.

The tire and load information table⁸ contains the recommended tire pressures for cold tires, the maximum permissible load and the maximum permissible vehicle speed.

The tire pressure table contains the recommended tire pressure for cold tires under various operating conditions, i.e. loading and/or speed of the vehicle.

Increased vehicle weight due to optional equipment

The combined weight of all standard and optional equipment available for the vehicle, regardless of whether it is actually installed on the vehicle or not.

Wheel rim

The part of the wheel on which the tire is mounted.

GAWR (Gross Axle Weight Rating)

GAWR is the maximum gross axle weight rating. The actual load on an axle must never exceed the gross axle weight rating. The Gross Axle Weight Rating can be found on the vehicle identification plate on the driver seat frame (▷ page 276).

Speed index

The speed index is part of the tire identification. It specifies the speed range for which the tire is approved.

GTW (Gross Trailer Weight)

GTW is the total of weight of a trailer and the weight of the load, accessories etc. on the trailer.

GVW (Gross Vehicle Weight)

The gross vehicle weight includes the weight of the vehicle including fuel, tools, spare wheel, accessories installed, occupants, luggage and the drawbar noseweight if applicable. The gross vehicle weight may never exceed the gross vehi-

⁸ Only for vehicles with a gross weight of less than 10,000 lbs (4536 kg).

cle weight rating (GVWR) specified on the vehicle identification plate at the base of the driver's seat (▷ page 276).

GVWR (Gross Vehicle Weight Rating)

The GVWR is the maximum permitted gross weight of the fully laden vehicle (weight of the vehicle including all accessories, occupants, fuel, luggage and the drawbar noseweight if applicable). The Gross Vehicle Weight Rating is specified on the vehicle identification plate on the driver seat frame (▷ page 276).

Maximum weight of the laden vehicle

The maximum weight is the sum of:

- the curb weight of the vehicle
- the weight of the accessories
- the load limit
- the weight of the factory installed optional equipment

Kilopascal (kPa)

Metric unit for tire pressure. 6.9 kPa are the equivalent of 1 psi. Another tire pressure unit is bar. 100 kilopascals (kPa) are the equivalent of 1 bar.

Load index

In addition to the load bearing index, a load index can be stamped onto the sidewall of the tire. It specifies the load-bearing capacity of the tire more precisely.

Curb weight

The weight of a vehicle with standard equipment including the maximum filling capacity of fuel, oil, and coolant. It also includes the air-conditioning system and optional equipment if these are installed on the vehicle, but does not include passengers or luggage.

Maximum tire load

The maximum tire load in kilograms or pounds is the maximum weight for which a tire is approved.

Maximum permissible tire pressure

Maximum permissible tire pressure for one tire.

Maximum load on one tire

Maximum load on one tire. This is calculated by dividing the maximum axle load of one axle by two.

PSI (Pounds per square inch)

Standard unit of measurement for tire pressure.

Aspect ratio

Relationship between tire height and width in percent.

tire pressure

Pressure inside the tire applying an outward force to every square inch of the tire's surface. Tire pressure is specified in pounds per square inch (psi), in kilopascal (kPa) or in bar. Tire pressure should only be corrected when the tires are cold.

Cold tire pressure

The tires are cold:

- if the vehicle has been parked for at least three hours without direct sunlight on the tires, and
- if the vehicle has not been driven further than 1 mile (1.6 km)

Tire tread

The part of the tire that comes into contact with the road.

Tire bead

The tire bead ensures that the tire sits securely on the wheel. There are several steel wires in the bead to prevent the tire from coming loose from the wheel rim.

Sidewall

The part of the tire between the tread and the tire bead.

Weight of optional extras

The combined weight of those optional extras that weigh more than the replaced standard parts and more than 2.3 kg (5 lbs). These optional extras, such as high-performance brakes, a roof rack or a high-performance battery, are not included in the curb weight and the weight of the accessories.

TIN (Tire Identification Number)

A unique identification number which can be used by a tire manufacturer to identify tires, for example for a product recall, and thus identify the purchasers. The TIN is composed of the manufacturer identification code, tire size, tire model code and manufacturing date.

Load bearing index

The load bearing index (also load index) is a code that contains the maximum load bearing capacity of a tire.

Traction

Traction is the result of friction between the tires and the road surface.

TWR (permissible trailer drawbar load)

The TWR is the maximum permissible weight that may act on the ball coupling of the trailer tow hitch.

Wear indicator

Narrow bars (tread wear bars) that are distributed over the tire tread. If the tire tread is level with the bars, the wear limit of $\frac{1}{16}$ in (1.6 mm) has been reached.

Distribution of the vehicle occupants

The distribution of vehicle occupants over designated seat positions in a vehicle.

Maximum permissible payload weight

Nominal load and goods/luggage load plus 68 kg (150 lbs) multiplied by the number of seats in the vehicle.

Flat tire

General notes

If your vehicle is equipped with a spare wheel, the spare wheel is under the rear of the vehicle (▷ page 272).

Information about installing a wheel can be found in the "Wheel change" section (▷ page 267).

Changing wheels

Rotating the wheels

WARNING

Interchanging the front and rear wheels may severely impair the driving characteristics if the wheels or tires have different dimensions. The wheel brakes or suspension components may also be damaged. There is a risk of accident.

Rotate front and rear wheels only if the wheels and tires are of the same dimensions.

I On vehicles equipped with a tire pressure monitor, electronic components are located in the wheel.

Tire-mounting tools should not be used near the valve. This could damage the electronic components.

Only have tires changed at a qualified specialist workshop.

Always observe the instructions and safety notes in the "Mounting a wheel" section (▷ page 267).

The wear patterns on the front and rear tires differ, depending on the operating conditions. Rotate the wheels before a clear wear pattern has formed on the tires. Front tires typically wear more on the shoulders and the rear tires in the center.

If your vehicle's tire configuration allows, you can rotate the wheels according to the intervals in the tire manufacturer's warranty book in your vehicle documents. If no warranty book is available, the tires should be rotated every 3,000 to 6,000 miles (5,000 to 10,000 km), or earlier if tire wear requires. Do not change the direction of rotation.

Clean the contact surfaces of the wheel and the brake disc thoroughly every time a wheel is rotated.

Check the tire pressure and reactivate the tire pressure monitor if necessary.

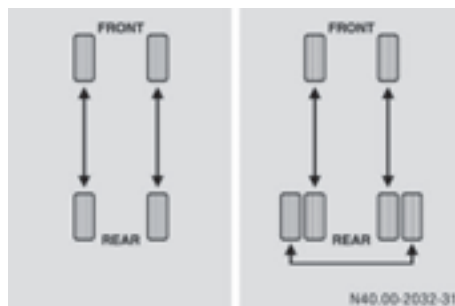

Diagram showing tire rotation for single and dual tires

Single tires: if the tires are of identical dimensions, you can rotate both wheels on both the front and rear axles so that the tires' original direction of rotation is maintained. On unidirec-

tional tires, an arrow on the sidewall shows the prescribed direction of rotation of the tire.

Twin rear tires: if the tires are of identical dimensions, you can rotate the wheels on the front axle and the inner wheels on the rear axle in pairs such that the original direction of tire rotation is retained. With unidirectional tires, you may rotate the outside wheels at the rear axle from one side to the other.

Direction of rotation

Tires with a specified direction of rotation have additional benefits, e.g. if there is a risk of hydroplaning. You will only gain these benefits if the correct direction of rotation is observed.

An arrow on the sidewall of the tire indicates its correct direction of rotation.

You may mount a spare wheel against the direction of rotation. Observe the time restriction on use as well as the speed limitation specified on the spare wheel.

Storing wheels

Store wheels that are not being used in a cool, dry and preferably dark place. Protect the tires from contact with oil, grease and fuel.

Mounting a wheel

Vehicle preparation

- ▶ Stop the vehicle as far away as possible from traffic and on a level, firm and non-slip surface.
- ▶ If your vehicle poses a risk to approaching traffic, switch on the hazard warning lamps.
- ▶ Apply the parking brake.
- ▶ Turn the front wheels to the straight-ahead position.
- ▶ Move the selector lever of the automatic transmission to position **P**.
- ▶ Switch off the engine.
- ▶ Passengers should leave the vehicle. Make sure that the passengers are not endangered as they do so.
- ▶ Make sure that no one is near the danger area while the wheel is being changed. Anyone who is not directly assisting in the wheel

change should, for example, stand behind the barrier.

- ▶ Place the warning triangle or warning lamp at a suitable distance. Observe legal requirements.
- ▶ Secure the vehicle to prevent it from rolling away.
- ⓘ Observe the safety notes on parking in the section on "Driving and parking" (> page 130).
- ▶ **On level terrain:** place chocks or other suitable objects under the front and rear of the wheel that is diagonally opposite the wheel to be changed.
- ▶ **On slight inclines:** place chocks or other suitable objects under the wheels on the front and rear axles opposite the wheel to be changed.
- ▶ Take the vehicle tool kit and the jack from the footwell on the front-passenger side (> page 240).
- ▶ Remove the spare wheel from the spare wheel bracket (> page 273). Observe the safety notes in the "Spare wheel" section (> page 272).
- ▶ On wheels with wheel bolts, remove the hub caps.

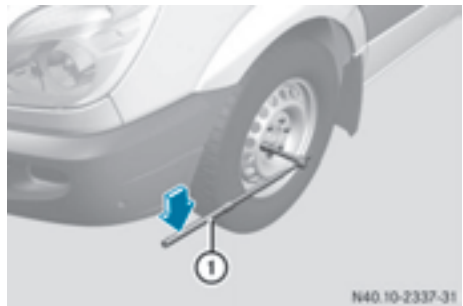

- ▶ Assemble the lug wrench extension using the middle rod and the rod with the largest diameter from the three-piece jack pump lever.
- ▶ Starting with the middle rod, slide the lug wrench extension as far as it will go onto the lug wrench.
- ▶ Using lug wrench ①, loosen the wheel bolts/wheel nuts on the wheel to be changed by about one full turn. Do not unscrew the wheel bolts/nuts completely.

Raising the vehicle

WARNING

If you do not position the jack correctly at the appropriate jacking point of the vehicle, the jack could tip over with the vehicle raised. There is a risk of injury.

Only position the jack at the appropriate jacking point of the vehicle. The base of the jack must be positioned vertically, directly under the jacking point of the vehicle.

WARNING

On uphill and downhill slopes, the jack could tip over with the vehicle raised. There is a risk of injury.

Do not change wheels on uphill or downhill gradients. Notify a qualified specialist workshop.

! Only position the jack on the jacking points intended for this purpose. You could otherwise damage the vehicle.

Observe the following when raising the vehicle:

- When raising the vehicle, only use the jack which Mercedes-Benz has specifically approved for your vehicle.
- The vehicle's jack is intended only to raise the vehicle for a short time when changing a wheel. It is not suited for performing maintenance work under the vehicle.
- Avoid changing the wheel on uphill and downhill slopes.
- Before raising the vehicle, secure it from rolling away by applying the parking brake and inserting wheel chocks. Never disengage the parking brake while the vehicle is raised.
- The jack must be placed on a firm, flat and non-slip surface. On a loose surface, a large, load-bearing underlay must be used. On a slippery surface, a non-slip underlay must be used, e.g. rubber mats.
- Make sure that the distance between the underside of the tires and the ground does not exceed 1.2 in (3 cm).
- Never place your hands or feet under the raised vehicle.
- Never lie under the raised vehicle.

- Never start the engine when the vehicle is raised.
- Never open or close a door when the vehicle is raised.
- Make sure that no persons are present in the vehicle when the vehicle is raised.

! Only use the jack pump lever middle rod and the rod with the largest diameter as a lug wrench extension. Only slide the middle rod as far as it will go onto the lug wrench. The rods may otherwise bend and be distorted to such an extent that they can no longer be used as a pump lever for the jack.

! Do not place the jack on the leaf spring or the differential case.

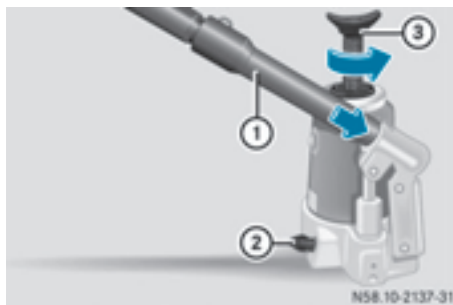

Hydraulic jack

Preparing the hydraulic jack

- ▶ Insert the third rod of jack pump lever ① into the lug wrench extension.
Jack pump lever ① is assembled.
- ▶ Close pressure release screw ②.
- ▶ To do this, use the flattened section on pump lever ① to turn pressure release screw ② clockwise to the stop.
- i** Do not turn pressure release screw ② more than 1 or 2 full turns. Hydraulic fluid could otherwise escape.
- ▶ Insert pump lever ① into the recess on the jack and secure by turning it clockwise.
- ▶ Place the jack vertically beneath the jacking points described below.

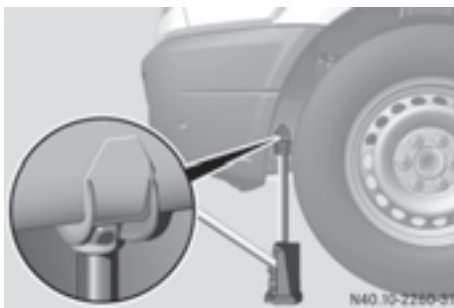

Jacking point, front axle

- ▶ Place the jack under the jacking point in front of the front axle.
- ▶ Vehicles with all-wheel drive: unscrew jack spindle ③ counter-clockwise as far as it will go.

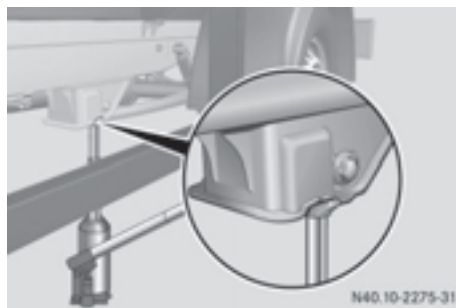

Jacking point, rear axle (example: Cab Chassis)

Jacking point at the rear axle on chassis versions

- ▶ Place the jack next to the front leaf spring support beneath the jacking point.

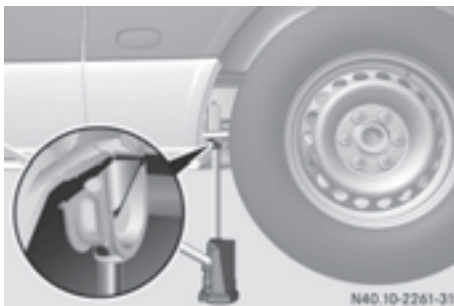

Jacking point, rear axle (example: vehicle type 2500)

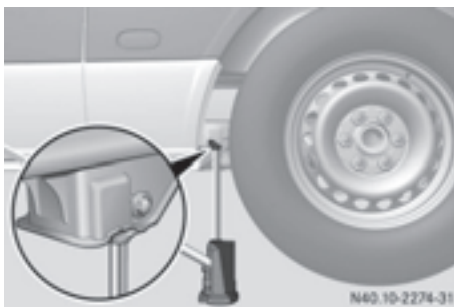

Jacking point, rear axle (example: vehicle type 3500)

- ▶ Place the jack under the jacking point in front of the rear axle.

Removing a wheel

! Do not place the wheel bolts or the wheel nuts in sand or dirt. The threads of the wheel bolts and wheel nuts could otherwise be damaged when being tightened.

- ▶ Unscrew the wheel bolts or nuts.
- ▶ On front wheels with wheel nuts, remove the wheel nut cover.
- ▶ Remove the wheel.

Installing the adapter

⚠ WARNING

If you tighten the adapter bolts when the vehicle is raised, the jack could tip over. There is a risk of injury.

Make sure that the vehicle is properly prepared for a wheel change. Tighten the adapter bolts with particular care and attention.

Always observe the instructions and safety notes on "Changing a wheel" (▷ page 266).

⚠ WARNING

If you do not tighten the bolts of the adapter to the specified tightening torque, the adapter may come loose with the spare wheel. There is a risk of an accident.

Tighten the bolts of the adapter to the specified tightening torque. Have the spare wheel replaced with a complete wheel and an extra-

wide tire at a qualified specialist workshop immediately.

! **Vehicles with Super Single tires:** if you install the spare wheel, do not exceed the maximum speed of 40 mph (60 km/h) and do not drive further than 65 miles (100 km).

The transmission could otherwise be damaged by the difference in wheel rotation speeds.

On vehicles with Super Single tires, you must attach the narrow spare wheel to the rear axle by means of an adapter. The adapter is bolted to the spare wheel using the adapter bolts for transportation.

The handling characteristics of your vehicle are affected when driving with a spare wheel installed. After changing a wheel, drive to the nearest specialist workshop and have the spare wheel replaced with a wheel and tire assembly that has a Super Single tire.

- ▶ Clean the wheel and wheel hub contact surfaces.
- ▶ Unscrew the six adapter bolts on the spare wheel and remove the adapter.
- ▶ Tighten the adapter with the six adapter bolts evenly in a crosswise pattern through the outer holes on the wheel hub.
- ▶ Tighten the six adapter bolts on the wheel hub to a tightening torque of **177 lb-ft (240 Nm)**.
- ▶ Push the wheel onto the adapter and attach it.

Mounting a new wheel

! WARNING

Oiled or greased wheel bolts or damaged wheel bolts/hub threads can cause the wheel bolts to come loose. As a result, you could lose a wheel while driving. There is a risk of accident.

Never oil or grease wheel bolts. In the event of damage to the threads, contact a qualified specialist workshop immediately. Have the damaged wheel bolts or hub threads replaced/renewed. Do not continue driving.

! WARNING

If you tighten the wheel bolts or wheel nuts when the vehicle is raised, the jack could tip over. There is a risk of injury.

Only tighten the wheel bolts or wheel nuts when the vehicle is on the ground.

Always observe the instructions and safety notes on "Changing a wheel" (▷ page 266).

Only use wheel bolts or wheel nuts that have been designed for the wheel and the vehicle. For safety reasons, we recommend that you only use wheel bolts or wheel nuts which have been approved for Sprinter vehicles and the respective wheel.

! For a steel wheel, only use the short wheel bolts to mount the steel spare wheel. Using other wheel bolts to mount the steel spare wheel could damage the brake system.

! On vehicles equipped with a tire pressure monitor, electronic components are located in the wheel.

Tire-mounting tools should not be used near the valve. This could damage the electronic components.

Only have tires changed at a qualified specialist workshop.

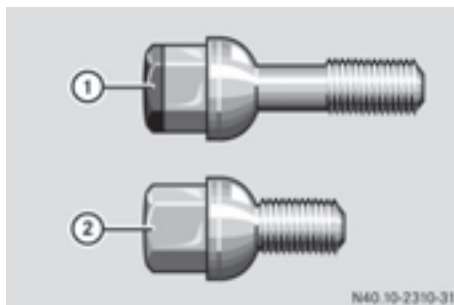

① Wheel bolt for alloy wheel

② Wheel bolt for steel wheel

- ▶ Clean the wheel and wheel hub contact surfaces.
- ▶ Vehicles with Super Single tires: first attach the adapter for the narrow spare wheel to the wheel hub (▷ page 269).

Slide the new wheel onto the wheel hub or onto the adapter for the spare wheel and push it on.

Slide the new wheel onto the wheel hub and push it on.

Wheels with centering by wheel bolts:

- ▶ Vehicles with alloy wheels: take the short wheel bolts that secure the steel spare wheel out of the vehicle tool kit.
- ▶ Screw in the wheel bolts and tighten them lightly.

For wheels with wheel nuts:

- ▶ Front wheels with wheel nut covers: press the wheel nut covers onto the wheel nuts.
- ▶ Screw in the three wheel nuts over the fixing discs of the wheel nut cover.
- ▶ Turn the wheel so that the wheel bolts are in the middle of the holes.
- ▶ Screw on the rest of the wheel nuts.
- ▶ Slightly tighten all the wheel nuts.

Lowering the vehicle

WARNING

The wheels could work loose if the wheel nuts and bolts are not tightened to the specified tightening torque. There is a risk of accident.

Have the tightening torque immediately checked at a qualified specialist workshop after a wheel is changed.

- ❗ Only use the jack pump lever middle rod and the rod with the largest diameter as a lug wrench extension. Only slide the middle rod as far as it will go onto the lug wrench. The rods may otherwise bend and be distorted to such an extent that they can no longer be used as a pump lever for the jack.

- ❗ **Vehicles with Super Single tires:** if you install the spare wheel, do not exceed the maximum speed of 40 mph (60 km/h) and do not drive further than 65 miles (100 km). The transmission could otherwise be damaged by the difference in wheel rotation speeds.

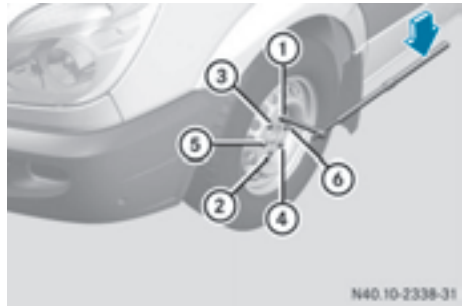

Tightening torque pattern

①—⑥ Wheel bolts or wheel nuts

- ▶ Using the pump lever, slowly turn the lowering screw on the jack through approximately one revolution and carefully lower the vehicle (> page 268).
- ▶ Put the jack aside.
- ▶ Pull the rod with the smallest diameter off the pump lever. The shortened pump lever serves as a lug wrench extension.
- ▶ Starting with the middle rod, slide the lug wrench extension as far as it will go onto the lug wrench.
- ▶ Using the extended lug wrench, tighten the wheel bolts evenly in a crosswise pattern in the sequence indicated (① to ⑥).

Tighten the wheel bolts to the following tightening torques:

- Steel wheel **177 lb-ft (240 Nm)**
- Alloy wheel **133 lb-ft (180 Nm)**

Tighten the wheel nuts to a tightening torque of **133 lb-ft (180 Nm)**.

- ▶ Push the piston on the hydraulic jack in again and close the pressure release screw.
- ▶ Vehicles with all-wheel drive: turn the jack spindle clockwise as far as it will go (> page 268).
- ▶ Stow the jack and the rest of the vehicle tools in the vehicle again.

i You can now install the hub caps on steel wheels with wheel bolts. The installing procedure depends on whether the hub cap acts as a trim that covers the whole wheel, or just covers the center.

- ▶ Wheel with hub cap: position the opening for the tire valve in the hub cap over the tire valve.
- ▶ Push the edge of the hub cap with both hands against the wheel until it clicks into place.

Make sure the hub cap retaining catches engage on the steel wheel.

- ▶ Wheel with central hub cap: position the retaining lugs of the central hub cap over the wheel bolts.
- ▶ Hit the middle of the hub cap to engage it on the wheel.
- ▶ Secure the faulty wheel in the spare wheel bracket (▷ page 273).
- ▶ Vehicles with Super Single tires: transport the defective rear wheel in the load area. The rear wheel is too large for the spare wheel bracket.
- ▶ Check the tire pressure of the newly mounted wheel and adjust it if necessary.
Observe the recommended tire pressure (▷ page 250).
- ▶ Retighten the wheel bolts or wheel nuts to the specified tightening torque after the vehicle has been driven for 30 miles (50 km).

When using a wheel or spare wheel with a new or newly painted wheel rim, have the wheel bolts or nuts retightened again after approximately 600 to 3,000 miles (1,000 to 5,000 km). Observe the specified tightening torque.

- i** Vehicles with the tire pressure monitor system: all mounted wheels must be equipped with functioning sensors.

Wheel and tire combination

General notes

- !** Retreaded tires are neither tested nor recommended for Sprinter vehicles, since previous damage cannot always be detected on retreaded tires. We can therefore not guarantee driving safety. Do not mount used tires if you have no information about their previous usage.

The recommended tire pressures can be found:

- on the Tire and Loading Information placard⁹ on the B-pillar on the driver's side
- on the tire pressure table on the B-pillar on the driver's side

The recommended tire pressure can also be found in the "Tire pressure table" section in this Operator's Manual (▷ page 257). The wheel/tire combination for your vehicle can be found on

the tire pressure table. Further information on wheel/tire combination can be obtained at any qualified specialist workshop.

Check tire pressures regularly and only when the tires are cold. Observe the notes on the recommended tire pressure (▷ page 250).

Follow the maintenance recommendations in the tire manufacturer's warranty book in your vehicle documents.

Notes on the vehicle equipment – always equip the vehicle:

- with tires of the same size across an axle (left and right)
- with the same type of tires on all wheels at a given time (summer tires, winter tires)

Tires that have been specially designed and approved for your vehicle are marked with MO (Mercedes-Benz Original). You can find this identification on the tires themselves and in the following table.

- i** Not all wheel/tire combinations can be installed at the factory in all countries.

Spare wheel

Important safety notes

WARNING

Wheel and tire dimensions as well as the type of tire can vary between the spare wheel and the wheel to be replaced. When the spare wheel is mounted, driving characteristics may be severely affected. There is a risk of an accident.

In order to reduce risks:

- you should therefore adapt your driving style and drive carefully.
- never mount more than one spare wheel that differs from the wheel to be replaced.
- only use a spare wheel that differs from the wheel to be replaced for a short time.
- do not deactivate ESP[®].
- have a spare wheel that differs from the wheel that has been changed replaced at the nearest qualified specialist workshop.

⁹ Only for vehicles with a gross weight of less than 10,000 lbs (4,536 kg).

You must observe the correct wheel and tire dimensions as well as the wheel type.

When using a spare wheel of a different size, do not exceed the maximum speed of 80 km/h.

General notes

! Check the spare wheel regularly to see that it is secure and has the prescribed tire pressure.

The procedure for mounting the spare wheel is described in "Mounting a wheel" (▷ page 267). The following should be checked regularly, particularly prior to long journeys:

- the tire pressure of the spare wheel, which should then be corrected if necessary (▷ page 250).
- the fastenings of the spare wheel bracket.

The spare wheel is located in a spare wheel bracket under the rear of the vehicle.

Replace the tires after 6 years at the latest, regardless of wear. This also applies to the spare wheel.

i If you have mounted a spare wheel, the tire pressure monitor (▷ page 253) will not function for this wheel. The spare wheel is not equipped with a sensor for monitoring tire pressure.

Removing and installing the spare wheel

Cargo Van/Passenger Van

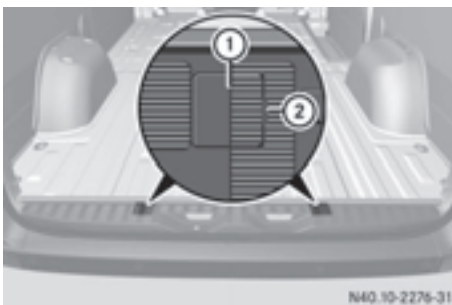

Bolt covers for the safety catches (example: Cargo Van)

Removing

- ▶ Open the rear doors.
- ▶ Place a screwdriver into recesses ② and then pry off covers ①.
- ▶ Using the lug wrench from the vehicle tool kit (▷ page 240), unscrew the now visible bolts counter-clockwise by approximately 20 turns.

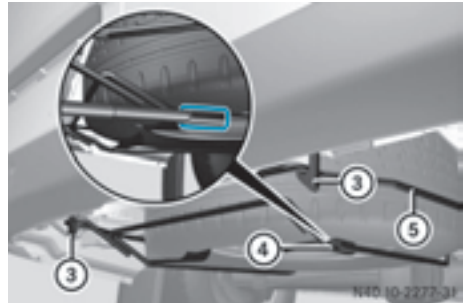

Spare wheel carrier under the vehicle

- ▶ Slightly raise spare wheel bracket ⑤ and unhook left-hand retaining hook ③.
- ▶ Assemble the pump lever for the jack and slide it into sleeve ④ on spare wheel bracket ⑤.
- ▶ Raise spare wheel bracket ⑤ with the pump lever and unhook right-hand retaining hook ③.
- ▶ Slowly lower spare wheel bracket ⑤ down to the ground.
- ▶ Lift spare wheel bracket ⑤ slightly and pull the pump lever out of sleeve ④.

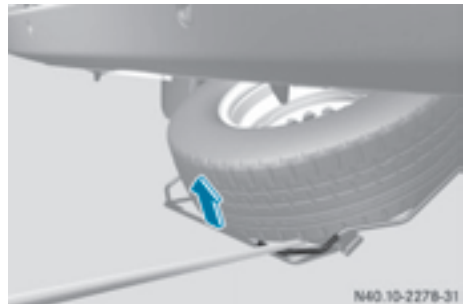

Spare wheel in the spare wheel carrier

- ▶ Use the pump lever to lift the spare wheel beyond the rear edge of the spare wheel carrier.
- ▶ Carefully remove the spare wheel from spare wheel bracket ⑤.
The spare wheel is heavy. When the spare wheel is removed, the center of gravity changes due to the heavy weight of the wheel. The spare wheel may slip down or tip over.

Installing

- ▶ Carefully place the spare wheel onto spare wheel bracket ⑤.
The spare wheel is heavy. When you place the spare wheel onto spare wheel bracket ⑤, the center of gravity changes due to the weight of the wheel. The spare wheel may slip down or tip over.
- ▶ Slide the pump lever for the jack into sleeve ④ on spare wheel bracket ⑤.
- ▶ Raise spare wheel bracket ⑤ with the pump lever and attach right-hand retaining hook ③.
- ▶ Slightly raise spare wheel bracket ⑤ and attach left-hand retaining hook ③.
- ▶ Pull the pump lever out of sleeve ④.
- ▶ Using the lug wrench, tighten the retaining hook bolts by turning them clockwise.
- ▶ Replace and engage covers ①.
- ▶ Close the rear doors.

Cab Chassis version

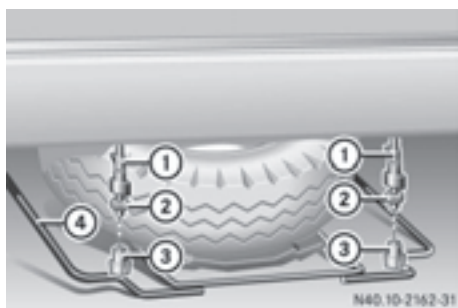

Removing

- ▶ Loosen fender nuts ③ manually and then remove them.
- ▶ Loosen nuts ② as far as the thread end.
- ▶ Slightly raise spare wheel bracket ④ and unhook left-hand retaining hook ①.

- ▶ Assemble the pump lever for the jack and slide it into the sleeve on the right-hand side of spare wheel bracket ④.
- ▶ Raise spare wheel bracket ④ with the pump lever and unhook right-hand retaining hook ①.
- ▶ Slowly lower spare wheel bracket ④ down to the ground.
- ▶ Lift spare wheel bracket ④ slightly and pull the pump lever out of the sleeve.



- ▶ Use the pump lever to lift the spare wheel beyond the rear edge of spare wheel bracket ④.
- ▶ Carefully remove the spare wheel from the bracket.
The spare wheel is heavy. When the spare wheel is removed, the center of gravity changes due to the heavy weight of the wheel. The spare wheel may slip down or tip over.

Installing

- ▶ Carefully place the spare wheel onto spare wheel bracket ④.
The spare wheel is heavy. When you place the spare wheel onto spare wheel bracket ④, the center of gravity changes due to the weight of the wheel. The spare wheel may slip down or tip over.
- ▶ Raise spare wheel bracket ④ with the pump lever and attach right-hand retaining hook ①.
- ▶ Slightly raise spare wheel bracket ④ and attach left-hand retaining hook ①.
- ▶ Pull the pump lever out.
- ▶ Tighten nuts ②.
- ▶ Put fender nuts ③ in place and tighten them.

Useful information

This Operator's Manual describes all models as well as standard and optional equipment of your vehicle that were available at the time of going to print. Country-specific variations are possible. Note that your vehicle may not be equipped with all of the described functions. This also applies to systems and functions relevant to safety.

Read the information on qualified specialist workshops (▷ page 26).

Vehicle electronics

Tampering with the engine electronics

⚠ WARNING

Always have work on the engine electronics and related components carried out at a qualified specialist workshop. Otherwise, the vehicle's operating safety could be affected.

! Only have engine electronics and the corresponding parts, such as control units, sensors or connector leads, serviced in a qualified specialist workshop. Otherwise, the vehicle parts may wear more quickly. This can lead to loss of the New Vehicle Limited Warranty.

Installing electrical or electronic equipment

⚠ WARNING

If you operate mobile communication equipment while driving, you will be distracted from traffic conditions. You could also lose control of the vehicle. There is a risk of an accident.

Only operate this equipment when the vehicle is stationary.

You and others can suffer health-related damage through electromagnetic radiation. By using an exterior antenna, a possible health risk caused by electromagnetic fields, as discussed in scientific circles, is taken into account. Only have the exterior antenna installed by a qualified specialist workshop.

Electrical and electronic devices may have a detrimental effect on both the comfort and the operating safety of the vehicle. If equipment of this kind is installed, its electromagnetic compatibility must be checked and verified.

If these devices are linked to functions associated with resistance to interference, they must have type approval. This applies to the device or its interfaces to the vehicle electronics, e.g. charging brackets.

A telephone or two-way radio to be installed in the vehicle must be approved. Further information can be obtained from any Sprinter Dealer.

For operation of mobile phones and two-way radios, Mercedes-Benz recommends connection to an approved exterior antenna. This is the only way to ensure optimum reception quality inside the vehicle and to minimize mutual interference between the vehicle electronics, mobile phones and two-way radios.

The transmission output of the mobile phone or two-way radio may not exceed the following maximum transmission output (PEAK):

Frequency range	Maximum transmission output (PEAK)
Shortwave (f < 50 MHz)	100 W
4 m waveband	30 W
2 m waveband	50 W
Trunked radio/Tetra	35 W
70 cm waveband	35 W
GSM/UMTS/LTE	10 W

Identification plates

Vehicle identification plate with vehicle identification number (VIN)



Vehicle identification plate for vehicles or chassis on the base of the driver's seat

- Open the driver's door. You will see vehicle identification plate ① with the vehicle identification number (VIN), the paint code and the permissible weight data.



Example: vehicle identification plate (US vehicles)



Example: chassis identification plate (US vehicles)



Example: chassis identification plate (vehicles for Canada)

- ② VIN
- ③ Paint code

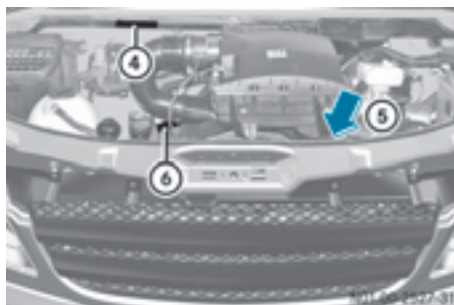

Engine compartment

- ④ VIN (stamped on the rear wall of the engine compartment)
- ⑤ Engine number (stamped on the crankcase)
- ⑥ Emission Control Information and engine oil¹⁰ instruction labels

- Open the hood (► page 218).



Example: Emission Control Information label

¹⁰ Also observe the notes on engine oil for diesel engines in the "Technical data" section.

- i** Such data is vehicle-specific and may differ from that shown. Always observe the specifications on your vehicle's identification plate.

Engine number

The engine number is stamped on the crankcase. More information may be obtained at any qualified specialist workshop.

Service products and capacities

Important safety notes

WARNING

Service products may be poisonous and hazardous to health. There is a risk of injury.

Comply with instructions on the use, storage and disposal of service products on the labels of the respective original containers. Always store service products sealed in their original containers. Always keep service products out of the reach of children.

Environmental note

Dispose of service products in an environmentally responsible manner.

Service products include the following:

- Fuels, e.g. diesel
- Additives for the exhaust gas aftertreatment, e.g. Diesel Exhaust Fluid (DEF)
- Lubricants, e.g. engine oil, transmission oil
- Coolant
- Brake fluid
- Washer fluid
- Climate control system refrigerants

Approved service products comply with the highest quality standards and are listed in the MB Specifications for Service Products. Only use service products approved for the vehicle. This is an important condition for the warranty. You will recognize the approved service products by the inscription on the container: MB Approval (e.g. MB Approval 228.5)

Other identifications and recommendations refer to quality level or a specification according

to an MB Sheet Number (e.g. MB 228.5). They are therefore not necessarily approved.

Further information can be obtained at any qualified specialist workshop.

Additives for approved service products are neither required nor permitted. Approved fuel additives are the exception. Additives can cause engine damage and must therefore not be added to the service products.

The use of additives is always the responsibility of the vehicle operator. The use of additives may result in the restriction or loss of your Limited Warranty entitlements.

Fuel

Important safety notes

WARNING

Fuel is highly flammable. Improper handling of fuel creates a risk of fire and explosion.

Avoid fire, open flames, smoking and creating sparks under all circumstances. Switch off the engine and, if applicable, the auxiliary heating before refueling.

WARNING

Fuel is poisonous and hazardous to health. There is a risk of injury.

You must make sure that fuel does not come into contact with your skin, eyes or clothing and that it is not swallowed. Do not inhale fuel vapors. Keep fuel away from children.

If you or others come into contact with fuel, observe the following:

- Wash away fuel from skin immediately using soap and water.
- If fuel comes into contact with your eyes, immediately rinse them thoroughly with clean water. Seek medical assistance without delay.
- If fuel is swallowed, seek medical assistance without delay. Do not induce vomiting.
- Immediately change out of clothing which has come into contact with fuel.

When handling, storing and disposing of fuels, please observe the relevant regulations.

Tank contents

Depending on equipment, the total capacity of the fuel tank may vary.

Vehicle type	Total capacity	of which reserve fuel
2500 3500	Approximately 26.4 US gal (100 l)	Approximately 5.0 US gal (19 l)
All-wheel-drive vehicle	Approximately 24.6 US gal (93 l)	

Diesel

Fuel grade

WARNING

If you mix diesel fuel with gasoline, the flash point is lower than that of pure diesel fuel. When the engine is running, exhaust system components could overheat without being noticed. There is a risk of fire.

Never refuel with gasoline. Never mix gasoline with diesel fuel.

-  Filter the fuel before transferring it to the vehicle if you are refueling the vehicle from barrels or containers.
This will prevent malfunctions in the fuel system due to contaminated fuel.

-  You will damage the diesel engine if you do not refuel with ULSD or a diesel fuel with a sulfur content of more than 15 ppm.

-  Do not use the following:

- Marine diesel
- Heating oil
- Bio-diesel
- Vegetable oil
- Gasoline
- Paraffin
- Kerosene

Do not mix such fuels with diesel fuel and do not use any special additives. This can otherwise lead to engine damage. This does not include flow improver additives. For further information, see "Flow improvers".

You will generally find information about the fuel grade on the filling pump. If there is no identification on the filling pump, consult a gas station attendant.

For more information about refueling ( page 127).

Diesel at very low outside temperatures

WARNING

If you heat fuel system components, e.g. with a hot-air gun or open flame, these components could be damaged. This can cause fuel to escape and ignite. Depending on the type of damage, fuel may also not escape until the engine is running. There is a risk of fire and explosion.

Never heat fuel system components. Contact a qualified specialist workshop to rectify the malfunction.

Refill only with commercially available ULTRA-LOW SULFUR DIESEL (ULSD, maximum sulfur content 15 ppm), which fulfills the ASTM D975 standard.

The flow properties of diesel may be inadequate at low outside temperatures due to paraffin separation.

-  Malfunctions resulting from paraffin separation can only be rectified by heating the entire fuel system. Park the vehicle in a heated garage, for example.

To prevent operating problems, diesel with better flow qualities is available during the winter months. You can obtain information at the gas station or from your fuel supplier.

Your vehicle is equipped with a fuel preheating system. This improves the flow properties of the diesel by approximately 46 °F (8 °C). ULTRA-LOW SULFUR DIESEL can be used without risk of malfunction down to an outside temperature of approximately 14 °F (-10 °C).

Fuel additives

! Do not add gasoline or kerosene to diesel fuel to improve its flow characteristics. Gasoline or kerosene impairs the lubricating properties of the diesel fuel. This can result in damage to the fuel injection system, for example.

Information on fuel consumption

Environmental note

CO₂ (carbon dioxide) is the gas which scientists believe to be principally responsible for global warming (the greenhouse effect). Your vehicle's CO₂ emissions are directly related to fuel consumption and therefore depend on:

- efficient use of the fuel by the engine
- driving style
- other non-technical factors, such as environmental influences, road conditions or traffic flow

You can minimize your vehicle's CO₂ emissions by driving carefully and having it serviced regularly.

Fuel consumption depends on:

- the vehicle version
- the style of driving
- the operating conditions
- the type or quality of the fuel used

The vehicle will use more fuel than usual in the following situations:

- at very low outside temperatures
- in city traffic
- during short journeys
- on mountainous terrain
- when towing a trailer

To keep fuel consumption low, observe the advice in the "Protection of the environment" section (▷ page 24).

The following components of the different vehicle versions influence fuel consumption:

- tire sizes, tire tread, tire pressure, tire condition
- body

- transmission ratios for the drive assemblies
- additional equipment (e.g. air-conditioning system, auxiliary heating system)

For these reasons, the actual consumption figures for your vehicle may deviate from the consumption figures determined according to EU Directive 80/1268/EEC.

Data concerning fuel consumption are recorded in the on-board computer; use the steering wheel buttons to call up the **Trip computer** menu (▷ page 174).

Diesel Exhaust Fluid (DEF)

General notes

Environmental note

Dispose of DEF in an environmentally responsible manner.

When opening the DEF tank filler cap at high outside temperatures, ammonia vapors may escape.

Ammonia vapors have a pungent smell and primarily cause irritation of the:

- skin
- mucous membranes
- eyes

You may experience a burning sensation in your eyes, nose and throat, as well as coughing and watering of the eyes.

Do not inhale ammonia vapors. Avoid contact with DEF.

Do not allow DEF to come into direct contact with your skin; it is hazardous to your health. Rinse any affected areas off with plenty of clean water. Consult a doctor if necessary.

If DEF heats up, e.g. in direct sunlight, in the DEF supply reservoir for some time to over 122 °F (50 °C), ammonia vapor will develop.

To conform to emission regulations, you must operate the vehicle with DEF and refill the supply regularly. The engine management recognizes attempts to operate the vehicle without DEF, with thinned DEF or with another reducing agent. After previous warning messages, the engine management then prevents a further engine start.

When the number of remaining engine starts is **0** the engine management prevents the vehicle from being driven at a speed exceeding 5 mph

(8 km/h). The multifunction display shows the **Idle Mode** message.

DEF consumption

DEF consumption depends on operational and driving conditions and it is not necessary to wait until the next scheduled service to replenish the fluid. Fluid should be added regularly to the DEF supply reservoir during vehicle operation or, at the latest, after receiving the first warning message via the on-board computer.

Low ambient temperatures

DEF freezes at a temperature of approximately 12 °F (-11 °C). The vehicle is equipped with a DEF preheating system at the factory. Winter operation is therefore also guaranteed at temperatures under 12 °F (-11 °C).

i If you add DEF at temperatures below 12 °F (-11 °C) it is possible that the level is not shown correctly due to the frozen DEF.

Drive for at least 20 minutes (heating phase in the tank activated) and then stop the vehicle for at least 30 seconds. The level is then shown correctly.

Additives

! Do not mix DEF with any additives and do not dilute DEF with tap water. Otherwise, the exhaust gas aftertreatment may be damaged.

Observe the MB Specifications for Service Products, Sheet No. 352.0.

Damage that arises through the use of additives or tap water will invalidate the New Vehicle Limited Warranty.

Storage

! Containers made of aluminum, copper, copper alloys as well as unalloyed or galvanized steel are not suitable for storing DEF. If stored in these types of containers, DEF could cause constituents of these metals to dissolve and cause irreparable damage to the exhaust gas aftertreatment.

Damage caused by such impurities in the DEF will invalidate the New Vehicle Limited Warranty.

Only store DEF in containers made of high-alloy Cr-Ni steel or Mo-Cr-Ni steel in accordance with DIN EN 10 088-1/2/3 or plastic containers made of polypropylene or polyethylene.

Purity

! Impurities in DEF (e.g. caused by other service products, cleaning agents, dust, etc.) result in increased emissions, malfunctions, catalytic converter damage or engine damage.

The purity of DEF is essential to prevent malfunctions in the exhaust gas aftertreatment.

If DEF is pumped out of the DEF tank, e.g. during repair work, the same liquid must not be used to refill the tank. Its purity is no longer guaranteed.

Disposal

Observe country-specific laws and regulations when disposing of DEF.

♻ Environmental note

Dispose of DEF in an environmentally responsible manner.

DEF supply reservoir content

Tank contents

Diesel Exhaust Fluid (DEF)¹¹

Approximately 4.7 US gal (18.0 l)

Engine oil

General notes



! The bottles of the various engine oil types are marked with ACEA (Association des Constructeurs Européens d'Automobiles) and/or API (American Petroleum Institute) classifications. Only use approved engine oils that conform to the following MB Specifications for Service Products and the prescribed ACEA and/or API classifications. Using engine oils

¹¹ DEF according to ISO 22241. Observe MB Specifications for Service Products, Sheet 352.0.

of another quality is not permitted and may invalidate the New Vehicle Limited Warranty.

The use of other, non-approved engine oils for diesel engines can cause damage to the diesel particle filter (DPF).

Use only engine oils that have been approved for your vehicle according to the MB Specifications for Service Products.

The MB Specifications for Service Products are valid for your vehicle¹²

- 228.51
- 229.31
- 229.51

These are high quality engine oils which have a positive effect on:

- engine wear
- fuel consumption
- exhaust gas emissions

Multi-grade engine oils of the prescribed SAE class (viscosity) may be used all year round, taking the outside temperatures into account.

Engine oil viscosity

! If the SAE viscosity class of the engine oil used does not cover the outside temperature range in which you are operating the vehicle, it must be changed in good time, in particular before the cold season commences. Using an engine oil that does not have adequate temperature characteristics can lead to engine damage.

The temperature range information of the SAE classification always refers to that of fresh oil. The temperature characteristics of the engine oil may deteriorate significantly due to aging in use, especially at low outside temperatures.

We recommend that you change the engine oil before the cold season commences. Use an approved engine oil of the specified SAE class.

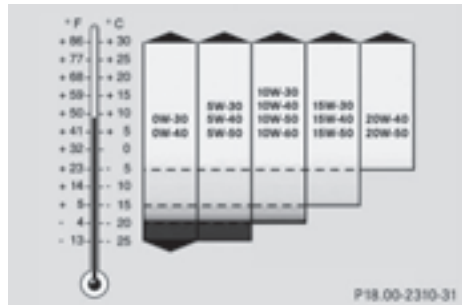

Engine oil SAE classification

Viscosity indicates the flow characteristics of a fluid. If an engine oil has a high viscosity, this means that it is thick; a low viscosity means that it is thin.

Depending on the respective outside temperatures, select an engine oil according to SAE classification (viscosity). The table displays the SAE classification to be used. The low temperature characteristics of engine oils can noticeably deteriorate during operation, e.g. from aging, soot and fuel accretion. For this reason, regular oil changes using an approved engine oil from the suitable SAE classification are urgently recommended.

Additives

! Do not use any additives in the engine oil. This could damage the engine.

Miscibility of engine oils

! Mixing oils reduces the benefits of using high grade engine oils.

We recommend that you only add engine oil of the same quality grade and SAE class as used when the engine oil was last changed.

If, in exceptional cases, oil of the type in the engine is not available, top up using another approved mineral or synthetic engine oil.

If the quality grade is not available for diesel engines, you may also add engine oils meeting the requirements in MB Sheet Number 228.5, 229.3 or 229.5. The quantity to be added is then limited to a maximum of 1 qt (1 l).

¹² If the quality grade is not available for diesel engines, you may also add engine oils meeting the requirements of MB Sheet No. 228.5, 229.3 or 229.5. The quantity to be added is then limited to a maximum of 1 qt (1 l).

Engine oils are differentiated according to:

- engine oil brand
- quality grade (sheet number)
- SAE class (viscosity)

Subsequently have the engine oil changed at the earliest possible opportunity.

Interval for oil change

The on-board computer automatically shows the date for the next oil change as an event message in the display.

Only by using engine oil with a particularly high quality grade, e.g. according to Sheet Number 228.51 of the Mercedes-Benz Specifications for Service Products, can the maximum interval for oil change be achieved.

We recommend having the oil changed at a qualified specialist workshop.

Engine oil for diesel engines

Product name/number

See the Maintenance Booklet.
MB Sheet Number 228.51, 229.31, 229.51

Capacities

! Do not add too much oil. adding too much engine oil can result in damage to the engine or to the catalytic converter. Have excess engine oil siphoned off.

Oil change including oil filter

Vehicles	Engine oil
4-cylinder	Approximately 3 US gal (11.5 l)
6-cylinder	Approximately 3.3 US gal (12.5 l)

Information about oil consumption

! If the vehicle is predominantly used for short-distance driving, this could lead to a malfunction in the automatic cleaning function for the diesel particle filter. As a result, fuel may accumulate in the engine oil and cause engine failure.

Therefore, if you mainly drive short distances, you should drive on a highway or on rural roads for 20 minutes every 310 miles

(500 km). This ensures sufficient regeneration of the diesel particle filter.

Depending on the driving style, the vehicle consumes a maximum of 1.0 qt (1.0 l) of engine oil over a distance of 620 miles (1000 km).

Oil consumption may be higher if:

- the vehicle is new.
- you mainly operate the vehicle under arduous operating conditions.
- you frequently drive at high engine speeds.

Regular maintenance is one of the preconditions for moderate rates of consumption.

You can only estimate the oil consumption after you have driven a considerable distance.

Check the engine oil level on a regular basis, e.g. weekly or each time you refuel (> page 220).

Transmission and power steering oil

Automatic transmission

Service product: automatic transmission fluid

Product name/number	Maintenance interval
Shell ATF 3403/M-115 MB Sheet No. 236.10	—
Fuchs/Shell ATF 3353 MB Sheet No. 236.12	

Further information can be obtained at any qualified specialist workshop.

Rear axle

Service product: transmission oil

Product name/number	Maintenance interval
BP Energear Hypo DC 80W-90 MB Sheet No. 235.20	—
Mobil Delvac Synthetic Gear Oil 75W-90 MB Sheet No. 235.8	

Further information can be obtained at any qualified specialist workshop.

Steering

Service product: power steering fluid

Product name/number	Maintenance interval
Mobil ATF-D, Exxon Mobil Corporation or equivalent MB Sheet No. 236.3	—

The steering is maintenance-free. Further information can be obtained at any qualified specialist workshop.

Brake fluid

WARNING

The brake fluid constantly absorbs moisture from the air. This lowers the boiling point of the brake fluid. If the boiling point of the brake fluid is too low, vapor pockets may form in the brake system when the brakes are applied hard. This would impair braking efficiency. There is a risk of an accident.

You should have the brake fluid renewed at the specified intervals.

! Brake fluid corrodes paint, plastic and rubber. If paint, plastic or rubber has come into contact with brake fluid, rinse with water immediately.

Only use brake fluids approved for Sprinter vehicles. Always check for the identification DOT 4 plus.

Information about approved brake fluids can be found in the Maintenance Booklet or obtained at any qualified specialist workshop.

Service product: brake fluid

Product description and number	Intac B026E <ul style="list-style-type: none"> • Boiling point: 500 °F (260 °C) • Wet boiling point: 356 °F (180 °C)
MB Sheet No.	331.0
Maintenance interval	2 years

i Have the brake fluid renewed every 2 years at a qualified specialist workshop.

There is usually a notice in the engine compartment to remind you when the next brake fluid change is due.

Coolant

Important safety notes

WARNING

If antifreeze comes into contact with hot components in the engine compartment, it may ignite. There is a risk of fire and injury.

Let the engine cool down before you add antifreeze. Make sure that antifreeze is not spilled next to the filler neck. Thoroughly clean the antifreeze from components before starting the engine.

! Take care not to spill any coolant on painted surfaces. You could otherwise damage the paintwork.

When handling, storing and disposing of coolant and antifreeze, please observe the relevant regulations and the safety notes in the "Service products and capacities" section (> page 277).

Coolant additive with antifreeze requirements

! Use only approved antifreeze/corrosion inhibitor that complies with MB Specification for Service Products, Sheet Number 325. Using other, non-approved antifreeze/corrosion inhibitors may cause damage to the cool-

ant system and reduce the engine's service life.

Coolant is a mixture of water and antifreeze/corrosion inhibitor. It performs the following tasks:

- corrosion protection
- antifreeze protection
- raises the boiling point

When the vehicle is first delivered, it is filled with a coolant mixture that ensures adequate antifreeze and corrosion protection. Coolant must be used in the system all year round to ensure anti-corrosion protection and a raised boiling point – even in countries with high outside temperatures.

To prevent damage to the engine cooling system, use only approved corrosion inhibitor/antifreeze that comply with the Mercedes-Benz Specifications for Service Products.

We recommend corrosion inhibitor/antifreeze that meets the requirements in MB Specifications for Service Products Sheet Number 325.

Check the antifreeze/corrosion inhibitor concentration in the coolant every six months.

The percentage of corrosion inhibitor/antifreeze additive in the engine cooling system should:

- be at least 50%. This way, the engine cooling system is protected against freezing down to approximately -35 °F (-37 °C).
- not exceed 55% (antifreeze protection down to -49 °F [-45 °C]). Otherwise, heat will not be dissipated as effectively.

If there has been coolant loss, do not refill only with water. If the vehicle has lost coolant, add equal parts water and corrosion inhibitor/antifreeze additive. The water used as part of the coolant mixture must fulfill certain requirements; these are usually fulfilled by drinking water. If the water quality is not sufficient, you must treat the water.

Service product: coolant

Product name/number

EURO Peak Coolant/Antifreeze,
OLD WORLD INDUSTRIES
MB Sheet No. 325.0

Zerex G05, The Valvoline Company
MB Sheet No. 325.0

Zerex G48, The Valvoline Company
MB Sheet No. 325.0

Glysantin G05, BASF AG
MB Sheet No. 325.0

Capacities

Engine cooling system

Coolant

Approx. 10.75 qt
(10.0 l)

Refrigerant

The air-conditioning system uses the refrigerant R-134a. This refrigerant does not damage the ozone layer.

Product name/number

Maintenance interval

Refrigerant R-134a
MB Sheet No. 361.0

—

Further information can be obtained at any qualified specialist workshop.

Washer fluid

Important safety notes

WARNING

Windshield washer concentrate could ignite if it comes into contact with hot engine components or the exhaust system. There is a risk of fire and injury.

Make sure that no windshield washer concentrate is spilled next to the filler neck.

! Only use washer fluid that is suitable for plastic lamp lenses, e.g. MB SummerFit or MB WinterFit. Unsuitable washer fluid could damage the plastic lenses of the headlamps.

When handling washer fluid, observe the important safety notes on service products (▷ page 277).

Mixing ratio

Add windshield washer concentrate to the washer fluid all year round. Adapt the mixing ratio to the ambient temperature.

At temperatures above freezing:

- ▶ Fill up the washer fluid reservoir with a mixture of water and windshield washer concentrate, e.g. Summerwash to prevent smearing.

At temperatures below freezing:

- ▶ Fill up the washer fluid reservoir with a mixture of water and windshield washer concentrate, e.g. Winterwash if there is a danger of frost.

This prevents washer fluid from freezing on the windshield.

Capacities

Windshield washer system with/without headlamp cleaning system

Washer fluid	Approx. 6.3 qt (6.0 l)
--------------	------------------------

Vehicle data

General notes

The following section contains important technical data for your vehicle. Your vehicle registration documents contain vehicle-specific and equipment-dependent technical data such as vehicle dimensions and vehicle weights.

Cargo tie-down points and carrier systems

Cargo tie-down points

General notes

! Observe the information on the maximum loading capacity of the individual cargo tie-down points.

If you use several cargo tie-down points to secure a load, you must always take the maximum loading capacity of the weakest cargo tie-down point into account.

If you brake hard, for example, the forces acting could be up to several times the weight force of the load. Always use multiple cargo tie-down points in order to distribute the force absorption. Load the anchorages evenly.

You will find further information about cargo tie down points and cargo tie-down rings in the "Transporting" section (▷ page 214).

Cargo tie-down rings

The maximum tensile load of the cargo tie-down rings is:

Cargo tie-down rings	Permissible nominal tensile load
Passenger Vans	786.5 lbf (3500 N)
Cargo Van	1124.0 lbf (5000 N)

Load rails

The maximum tensile loads of the cargo tie-down points in the cargo compartment are:

Cargo tie-down point	Permissible nominal tensile load
Load rails on cargo compartment floor	1124.0 lbf (5000 N)
Lower load rail on sidewall	562.0 lbf (2500 N)
Upper load rail on sidewall	337.0 lbf (1500 N)

The values specified apply only to loads placed on the cargo compartment floor if:

- the load is secured to 2 cargo tie-down points on the rail and
- the distance to the nearest load-securing point on the same rail is approximately 3 ft (1 m).

Roof carrier

WARNING

When you load the roof, the center of gravity of the vehicle rises and the driving characteristics change. If you exceed the maximum roof load, the driving characteristics, as well as steering and braking, will be greatly impaired. There is a risk of an accident.

Never exceed the maximum roof load and adjust your driving style.

WARNING

If you distribute the load unevenly in the vehicle, the handling as well as the steering and braking characteristics are severely affected. There is a risk of an accident.

Distribute the load evenly in the vehicle. Secure the load to prevent it from slipping.

- !** The weight of any load carried on the roof, including the roof carrier, must not exceed the maximum permissible roof load.

The roof carrier supports must be mounted at equal distances.

We recommend that you have a stabilizer installed on the front axle.

- !** For safety reasons, we recommend that you only use roof carrier systems that have been tested and approved for the Sprinter. This will help to avoid damage.

The data is valid for a load distributed evenly over the entire roof area. Maximum roof load and minimum number of pairs of roof carrier supports on vehicles with:

	Maximum roof load	Minimum number of pairs of supports
Standard roof	660 lbs (300 kg)	6
High roof	330 lbs (150 kg)	3

Reduce the load on shorter roof carriers proportionately. The maximum load per pair of roof carrier supports is 110 lbs (50 kg).

Loading directions and other information concerning load distribution and load securing can be found in the "Transporting" section ([▷ page 212](#)).

Trailer tow hitch

General notes

We recommend that you have the trailer tow hitch mounted at an authorized Sprinter Dealer.

Use only a trailer tow hitch that has been tested and approved specially for your vehicle by the distributor named on the inside of the front cover. Only use a ball coupling that is approved for your vehicle and Sprinter trailer tow hitch. You can also find information on the permitted dimensions of the ball coupling on the identification plate of the trailer tow hitch.

You can obtain advice from a qualified specialist workshop. Also observe the information on towing a trailer in the "Driving and parking" section ([▷ page 155](#)).

Maximum permitted weights and loads

! On vehicles with a permissible gross vehicle weight of 11030 lbs (5003 kg), the permissible gross combination weight is less than the total of the permissible gross vehicle weight and the permissible trailer load. Exceeding the permissible gross combination weight can lead to damage to the drivetrain, to the transmission or to the trailer tow hitch.

If the vehicle or the trailer is fully laden, the relevant value for the permissible gross vehicle weight or the permissible trailer load is therefore lower. In this case, the trailer or the vehicle may only be partially loaded.

The permissible weights and loads which cannot be exceeded can also be found:

- in your vehicle documents and
- on the identification plates of the trailer tow hitch, trailer and vehicle (▷ page 276).

You will find the basic values approved by the manufacturer in the following table. If the values differ, the lowest value applies.

Make sure that you adhere to the weight restrictions by having the weight checked on a calibrated weighbridge.

Vehicle type	Permissible gross weight GVWR	Gross front axle load GAWR (FA)	Gross rear axle load GAWR (RA)	Maximum permissible gross weight of vehicle/trailer combination ¹³ GCWR	Trailer load ¹⁴ GTW	Maximum permissible nose weight TWR
2500	8550 lbs (3878 kg)	3970 lbs (1801 kg)	5360 lbs (2431 kg)	13550 lbs (6146 kg)	5000 lbs (2268 kg)	500 lbs (227 kg)
3500	9900 lbs (4490 kg) Canada only	4080 lbs (1851 kg)	7060 lbs (3202 kg)	14900 lbs (6759 kg) ¹⁵	5000 lbs (2268 kg) ¹⁵	500 lbs (227 kg) ¹⁵
		4410 lbs (2000 kg)		15250 lbs (6917 kg) ¹⁶	7500 lbs (3402 kg) ¹⁶	750 lbs (340 kg) ¹⁶
	9990 lbs (4531 kg) USA only	4080 lbs (1851 kg)	7060 lbs (3202 kg)	14990 lbs (6799 kg) ¹⁵	5000 lbs (2268 kg) ¹⁵	500 lbs (227 kg) ¹⁵
		4410 lbs (2000 kg)		15250 lbs (6917 kg) ¹⁶	7500 lbs (3402 kg) ¹⁶	750 lbs (340 kg) ¹⁶
10141 lbs (4600 kg)	4080 lbs (1851 kg)	7060 lbs (3202 kg)	14990 lbs (6799 kg) ¹⁵	5000 lbs (2268 kg) ¹⁵	500 lbs (227 kg) ¹⁵	
	4410 lbs (2000 kg)		15250 lbs (6917 kg) ¹⁶	7500 lbs (3402 kg) ¹⁶	750 lbs (340 kg) ¹⁶	

¹³ Maximum permissible gross weight of the vehicle and trailer

¹⁴ Maximum permissible gross weight of the trailer

¹⁵ Only for extra-long vehicles with an overall length of 289.2 in (7344 mm).

¹⁶ Not for extra-long vehicles with an overall length of 289.2 in (7344 mm).

Vehicle type	Permissible gross weight GVWR	Gross front axle load GAWR (FA)	Gross rear axle load GAWR (RA)	Maximum permissible gross weight of vehicle/trailer combination ¹³ GCWR	Trailer load ¹⁴ GTW	Maximum permissible nose weight TWR
	11030 lbs (5003 kg)	4080 lbs (1851 kg)	7720 lbs (3502 kg)	15250 lbs (6917 kg)	5000 lbs (2268 kg) ¹⁵	500 lbs (227 kg) ¹⁵
		4410 lbs (2000 kg)			7500 lbs (3402 kg) ¹⁶	750 lbs (340 kg) ¹⁶

¹³ Maximum permissible gross weight of the vehicle and trailer

¹⁴ Maximum permissible gross weight of the trailer

¹⁵ Only for extra-long vehicles with an overall length of 289.2 in (7344 mm).

¹⁶ Not for extra-long vehicles with an overall length of 289.2 in (7344 mm).